

organizer/listino 2022



Architectural design

FLORIM È CERTIFICATA B CORP

FLORIM IS
B CORP
CERTIFIED

Guardiamo al business come una forza positiva in grado di generare profitto e allo stesso tempo creare un impatto virtuoso sulle persone e sull'ambiente. Da sempre.

Le nostre scelte, giorno dopo giorno, ci hanno portato a migliorare il nostro modo di fare impresa.

We conceive the business as a positive force able to generate profits and at the same time create a virtuous impact on people and the environment. Since forever.

Our choices, day after day, have led us to improve our way of doing business.

COSA SIGNIFICA ESSERE B CORP?

Ci siamo misurati con i **più alti standard di performance sociale e ambientale** e dopo un lungo e rigoroso processo di verifica **siamo diventati B Corp.**

Le aziende che riescono a ottenere questa certificazione sono le più evolute al mondo in termini di impatto positivo sia sociale che ambientale.

Costituiscono un movimento globale di 'Purpose Driven Businesses' che ha l'obiettivo di diffondere un nuovo **paradigma economico**, che vede le imprese come protagoniste nel **rigenerare la società.**

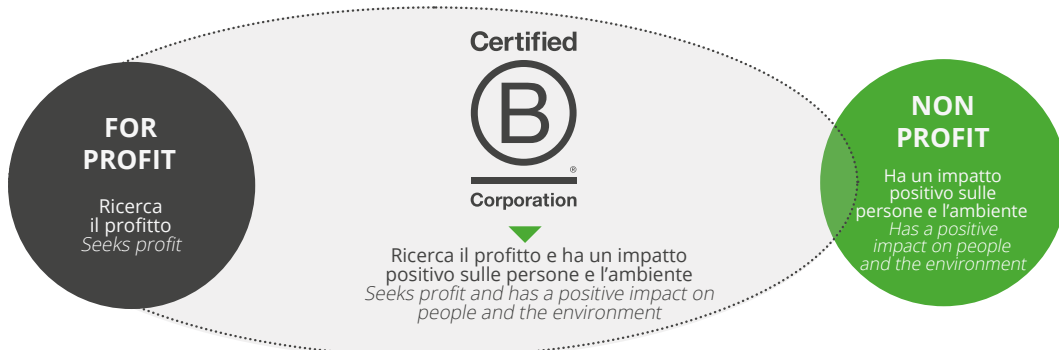

Certified



Corporation



Guarda il video "Essere sostenibile è una scelta quotidiana" con i volti di alcune delle "persone Florim" che ogni giorno contribuiscono a rendere l'azienda sempre più responsabile.
Watch the video "Being sustainable is a daily choice" with the faces of some of the "Florim people" who contribute to making the company even more responsible, every day.

WHAT DOES IT MEAN TO BE B CORP?

We vied with the **highest social and environmental performance standards**, and after a long and scrupulous verification process, **we became B Corp.**

Companies that succeed in obtaining this certification are the most evolved in the world in terms of their positive social and environmental impact.

They constitute a global movement of 'Purpose Driven Businesses' whose aim is to diffuse a **new economic paradigm**, whereby companies are the drivers of **social regeneration.**

BUSINESS RIGENERATIVO

È in corso un **cambiamento culturale** epocale di cui siamo orgogliosi di essere parte. Uno dei principi fondamentali di tutte le B Corp è quello di adottare un business rigenerativo che si contrappone a quello estrattivo.

Rigenerare significa non solo diminuire l'impatto sulla natura e sull'ambiente che ci circonda, ma addirittura produrre effetti positivi, creando valore condiviso nella società e rigenerando la biosfera.

Diventano B Corp solo quelle aziende che misurano il loro impatto complessivo attraverso il Benefit Impact Assessment (BIA) superando il punteggio di 80 (in una scala da 0 a 200) ed entrando così in una élite di imprese **rigenerative**. Chi non supera questa soglia viene considerata **azienda estrattiva** ovvero per funzionare consuma risorse economiche, sociali e ambientali superiori di quanto sia in grado di generare come output.

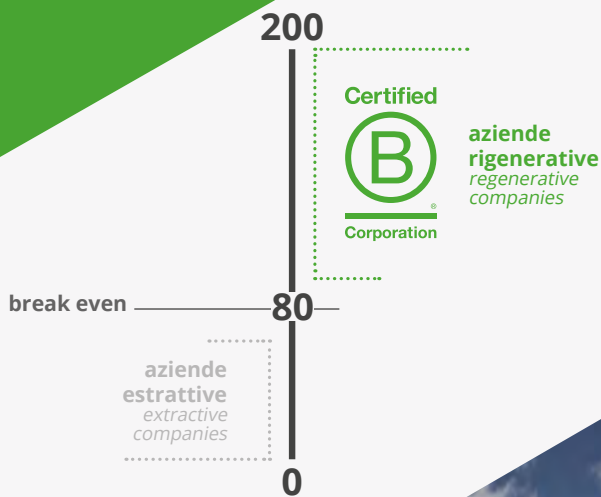

REGENERATIVE BUSINESS

An historical **cultural shift** is under way, of which we are proud to be a part. One of the underlying principles of all B Corps is the adoption of a regenerative business model as opposed to an extractive one.

Regenerating means not only reducing the impact of business on our surrounding nature and environment, but also producing **positive effects, creating shared value in society and regenerating the biosphere.**

Only those companies that measure their overall impact through the Benefit Impact Assessment (BIA) exceeding the score of 80 points can be certified as B Corp, joining an elite of **regenerative companies**. Anyone who does not exceed this threshold is considered an **extractive company** or, in order to function, they consume higher economic, social and environmental resources than they are able to generate as output.

IL PUNTEGGIO DI FLORIM

Il punteggio conseguito da Florim Italia è di 98,1 punti e il consolidato, che comprende la consociata americana, è di 90,9 punti. Così il Gruppo Florim rientra tra le 3.700 B Corp al mondo.

Sono oltre 140.000 le aziende che stanno cercando di ottenere la certificazione, nel rispetto di **severissimi standard di trasparenza e sostenibilità.**

Solo il 3% riesce a superare l'iter di verifica imposto da **B Lab**, ente certificatore di origine americana che oggi opera a livello globale.

FLORIM'S SCORE

Florim Italia score is 98.1 points and the consolidated, which includes the American subsidiary, is 90.9 points. Florim Group is now one of the 3,700 B Corps throughout the world.

More than 140,000 companies are currently seeking to obtain the certification **in compliance with the strictest transparency and sustainability standards.**

Only 3% manage to pass the verification process implemented by **B Lab**, the US certifying body that currently operates on a global scale.

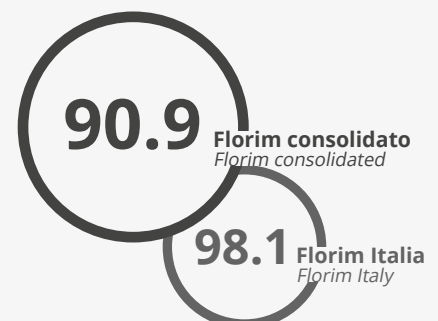

Azienda

Produciamo superfici ceramiche da quasi 60 anni con **passione, innovazione, impegno costante al miglioramento e responsabilità sociale** d'impresa. Sono queste le linee guida che contraddistinguono il nostro modo di fare impresa: il **MADE IN FLORIM**.

We produce porcelain stoneware surfaces with **passion, innovation and in a socially responsible way**. Those are the guidelines that identify our business and which can be summed up in a few words: **MADE IN FLORIM**.

Nous produisons des surfaces céramiques depuis près de 60 ans avec **passion, innovation, recherche et une attention à la responsabilité sociale d'entreprise**. Ce sont les lignes phares qui guident notre mode de travailler: le **MADE IN FLORIM**.

Wir produzieren seit fast 60 Jahren Keramikoberflächen mit **Leidenschaft, Innovationsgeist, ständigem Engagement für Verbesserungen und sozialer Unternehmensverantwortung**. Dies sind die Prinzipien, die unsere Arbeitsweise auszeichnen: kurz **MADE IN FLORIM**.

Producimos superficies cerámicas desde hace casi 60 años con **pasión, innovación, compromiso de mejora constante y responsabilidad social**. Estos son los valores distintivos de nuestro modo de hacer empresa: el **MADE IN FLORIM**.

Мы производим керамогранитные поверхности социально ответственным образом со страстью и инновациями. Это основные принципы, которые определяют наш бизнес и которые могут быть кратко изложены в нескольких словах: **MADE IN FLORIM**.



Architectural design

Materiale tecnico seguendo le tendenze dell'architettura, per applicazioni quali pavimentazioni industriali e realizzazioni pubbliche a medio e ad alto traffico, come aeroporti, centri commerciali, ristoranti, uffici, negozi, ma anche applicazioni residenziali con un mirato contenuto estetico.

Technical material in line with architectural trends, for applications such as industrial flooring and public buildings with medium to high footfall, such as airports, shopping centres, restaurants, offices, shops, as well as residential applications featuring a targeted aesthetic content.

Matériau technique suivant les tendances de l'architecture, pour des applications en tant que sols industriels et des réalisations publiques à trafic moyen et intense, comme les aéroports, les centres commerciaux, les restaurants, les bureaux, les magasins, mais aussi pour des applications résidentielles au contenu esthétique ciblé.

Technisches Material im Einklang mit den architektonischen Trends für Anwendungen wie Industrieböden und mittelhoch bis stark frequentierte öffentliche Bereiche wie Flughäfen, Einkaufszentren, Restaurants, Büros und Läden, aber auch für Wohngebäude mit wertiger Optik.

Material técnico que sigue las tendencias de la arquitectura, creado para pavimentos industriales y ambientes públicos de mediano y alto tránsito —como aeropuertos, centros comerciales, restaurantes, oficinas y tiendas—, pero también para aplicaciones residenciales con un refinado contenido estético.

технические покрытия, следующие современным архитектурным тенденциям, предназначенные для промышленных полов и объектов общественного назначения со средней и высокой эксплуатационной нагрузкой, таких как аэропорты, торговые центры, рестораны, офисы, магазины, а также для оформления жилых интерьеров особой направленности.

performance



appeal



project



ecobuilding

Indice



gres fine porcellanato

fine porcelain stoneware / grès cérame fin
feinsteinzeug-kollektionen / gres porcelánico fino
фарфоровый керамогранит

14/27	Airtech
28/39	B&W_Marble
40/59	Buildtech/2.0
66/89	Earthtech
90/99	Floortech
100/107	Flowtech
108/121	Industrial
122/127	Piscine
128/137	Rawtech
138/149	Stontech/4.0
150/155	Tech#2
156/165	Walks/1.0

gres porcellanato decorato

decorated porcelain tiles
grès cérame décoré
verziertes feinsteinzeug
gres porcelánico decorado
ДЕКОРИРОВАННЫЙ КЕРАМОГРАНИТ

60/65	Buildtech/2.0
--------------	---------------



La simbologia

SYMBOL/SYMBOLS/SYMBOL/SIMBOLOGIA/Символы

DIN 51130: Scivolosità a piedi calzati: il materiale ceramico viene posto su un piano e oliato. Successivamente il piano viene progressivamente inclinato, mentre un operatore con scarpa di gomma cammina lungo il piano fino a quando non inizia a scivolare; la misura dell'angolo che si forma tra il piano inclinato e il suolo all'inizio dello scivolamento determina la classificazione del materiale. / Shod foot slipperiness: the ceramic material is placed on a surface and oiled. Subsequently, the surface is progressively tilted, while an operator with rubber shoes walks along the surface until he starts to slip; the measurement of the angle that is formed between the inclined surface and the ground when the slipping starts determines the classification of the material. / Glissance pieds chaussés : le matériau céramique est mis sur un plan et huilé. Le plan est ensuite incliné progressivement, tandis qu'un opérateur avec des chaussures en caoutchouc marche le long du plan jusqu'à ce qu'il ne commence à glisser ; la mesure de l'angle qui se forme entre le plan incliné et le sol au début du glissement donne la classification du matériau. / Rutsicherheit auf Schuhen: Das Keramikmaterial wird auf einer Fläche angebracht und mit einem Gleitmittel bestrichen. Daraufhin wird die Fläche nach und nach geneigt, während eine Prüfperson mit Gummischuhen die Fläche entlangläuft, bis sie ins Rutschen gerät. Die Größe des Winkels, der zwischen der geneigten Fläche und dem Boden zu Beginn der Rutschtbewegung entsteht, bestimmt die Klassifizierung des Materials. / Deslizamiento con pies descalzos: el material cerámico se coloca sobre un plano y se aceita. Seguidamente el plano se inclina progresivamente, mientras que un operador con calzado de goma camina a lo largo del plano hasta que empieza a resbalar; la medida del ángulo que se forma entre la superficie inclinada y el suelo al principio del deslizamiento determina la clasificación del material. / **устойчивость к скольжению при хождении в обуви: керамический материал укладывается на поверхность и покрывается маслом. Затем поверхность постепенно наклоняется, а оператор в резиновой обуви ходит по поверхности до тех пор, пока не начинает скользить; размер угла, образованного наклоненной поверхностью и основанием на момент начала скольжения определяет классификацию материала**

DIN 51097: Scivolosità a piedi nudi: il materiale ceramico viene posto su un piano e bagnato. Successivamente il piano viene progressivamente inclinato, mentre un operatore con piede nudo cammina lungo il piano fino a quando non inizia a scivolare; la misura dell'angolo che si forma tra il piano inclinato e il suolo all'inizio dello scivolamento determina la classificazione del materiale. / Barefoot slipperiness: the ceramic material is placed on a surface and made wet. Subsequently, the surface is progressively tilted, while an operator with bare feet walks along the surface until he starts to slip; the measurement of the angle that is formed between the inclined plane and the ground when slipping starts determines the classification of the material. / Glissance pieds nus : le matériau céramique est mis sur un plan et mouillé. Le plan est ensuite incliné progressivement, tandis qu'un opérateur pieds nus marche le long du plan jusqu'à ce qu'il ne commence à glisser ; la mesure de l'angle qui se forme entre le plan incliné et le sol au début du glissement donne la classification du matériau. / Rutsicherheit barfuß: Das Keramikmaterial wird auf einer Fläche angebracht und befeuchtet. Daraufhin wird die Fläche nach und nach geneigt, während eine Prüfperson barfuß die Fläche entlangläuft, bis sie ins Rutschen gerät. Die Größe des Winkels, der zwischen der geneigten Fläche und dem Boden zu Beginn der Rutschtbewegung entsteht, bestimmt die Klassifizierung des Materials. / Deslizamiento con pies descalzos: el material cerámico se pone sobre un plano y se moja. Seguidamente el plano se inclina progresivamente, mientras que un operador con los pies descalzos camina a lo largo del plano hasta que empieza a resbalar; la medida del ángulo que se forma entre la superficie inclinada y el suelo al principio del deslizamiento determina la clasificación del material. / **устойчивость к скольжению при хождении босиком: керамический материал укладывается на поверхность и смачивается водой. Затем поверхность постепенно наклоняется, а оператор ходит босиком по поверхности до тех пор, пока не начинает скользить; размер угла, образованного наклоненной поверхностью и основанием на момент начала скольжения определяет классификацию материала.**

DCOF: Coefficiente di attrito dinamico: viene misurata la forza necessaria per mantenere in movimento un elemento (BOT 3000) rivestito in gomma dalla superficie della piastrella in condizioni di superficie bagnata; il rapporto tra la forza necessaria e il peso dell'elemento scivolante indica il Coefficiente di attrito dinamico. / Dynamic coefficient of friction: the force required to maintain the movement of an element (BOT 3000) coated with rubber on the surface of the tile in wet surface conditions is measured; the relationship between the force required and the weight of the slipping element indicates the dynamic coefficient of friction. / Coefficient de frottement dynamique : la force nécessaire pour maintenir en mouvement un élément (BOT 3000) revêtu en caoutchouc sur la surface du carreau en conditions de surface mouillée est mesurée ; la relation entre la force nécessaire et le poids de l'élément glissant indique le coefficient de frottement dynamique. / Dynamischer Reibungskoeffizient: Gemessen wird die Kraft, die erforderlich ist, um ein Element mit Gummiverkleidung (BOT 3000) durch die Fliese bei nasser Oberfläche in Bewegung zu halten. Das Verhältnis zwischen der erforderlichen Kraft und dem Gewicht des gleitenden Elements gibt den dynamischen Reibungskoeffizienten wieder. / Coeficiente de fricción cinética: se mide la fuerza necesaria para mantener en movimiento un elemento (BOT 3000) revestido de goma por la superficie de la baldosa bajo condiciones de superficie mojada; la relación entre la fuerza necesaria y el peso del elemento que resbala indica el Coeficiente de fricción dinámica. / **коэффициент динамического трения: измеряется сила, необходимая для поддержания одного элемента (BOT 3000) с резиновым покрытием в движении на плитке в условиях влажной поверхности; соотношение между необходимой для этого силой и весом элемента является коэффициентом динамического трения.**

SQUADRATO / SQUARED / EQUARRI / REKTIFIZIERT / ESCUADRADO / Калиброванная

Piastrelle o lastre ceramiche portate a dimensioni predefinite, ognuno esattamente uguale all'altra (monocalibro) con sistema di mole abrasive. / Ceramic tiles or slabs made to a pre-defined size, each one exactly the same as the others (single size), using a system of abrasive grinders. / Carreaux ou dalles céramiques mises aux dimensions prédéfinies, parfaitement identiques l'une à l'autre (mono-calibre) grâce à un système de disques abrasifs. / Fliesen oder Keramikplatten mit festgelegten Formaten. Alle Fliesen sind aufgrund der Verwendung des Schleifscheiben-Systems hundertprozentig identisch (Monokaliber). / Baldosas o piezas de cerámica que se realizan con dimensiones predefinidas, cada pieza es exactamente igual a la otra (mono dimensión) con sistema de discos abrasivos. / **Керамическая плитка или плиты, доведенные шлифовальными кругами до установленных размеров, все изделия одинаковы (один калибр).**

Grado di variazione cromatica

DEGREE OF COLOUR CHANGE/DEGRE DE VARIATION CHROMATIQUE/GRAD DER FARBABWEICHUNG/GRADO DE VARIACIÓN CROMÁTICA/
СТЪПЪНЬ ХРОМКИЧЪСКООО ИЗМЪНЪНИЯ

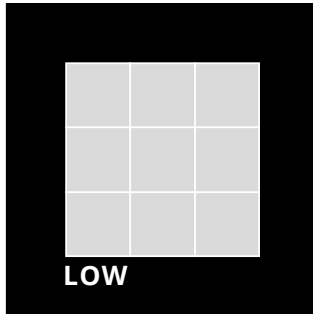

v1

PRODOTTO MONOCROMATICO.

The least amount of shade and texture variation.

Attainable in naturally fired clay products.

Produit monochromatique.

Eifarbiges produkt.

Producto monocromático.

ОДНОЦВЕТНАЯ ПРОДУКЦИЯ.

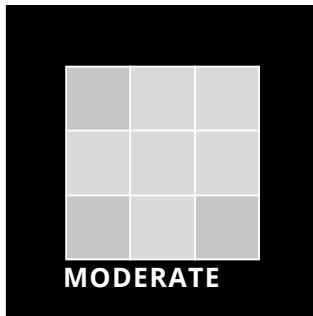

v2

PRODOTTO CON LEGGERA VARIAZIONE CROMATICA.

Light to moderate shade and texture variation within each carton.

Produit à légère variation chromatique.

Produkt mit leichter farbnuance.

Producto con una pequeña variación cromática.

ПРОДУКЦИЯ С ЛЕГКИМИ ЦВЕТОВЫМИ ИЗМЕНЕНИЯМИ.

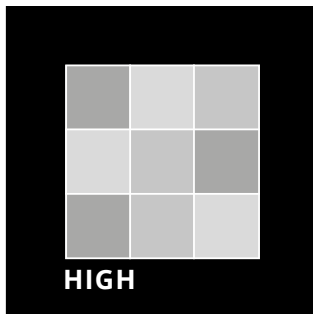

v3

PRODOTTO CON MARCATA VARIAZIONE CROMATICA.

High shade texture variation within each carton.

Produit à variation chromatique accentuée.

Produkt mit ausgeprägter farbnuance.

Producto con evidente variación cromática.

ПРОДУКЦИЯ С ЯРКИМИ ЦВЕТОВЫМИ ИЗМЕНЕНИЯМИ.

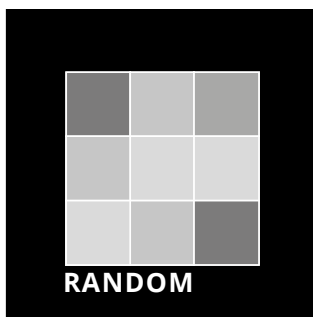

v4

PRODOTTO CON FORTE VARIAZIONE CROMATICA.

Very high shade and texture variation within each carton.

Produit à forte variation chromatique.

Produkt mit starker farbnuance.

Producto con fuerte variación cromática.

ПРОДУКЦИЯ С СИЛЬНЫМИ ЦВЕТОВЫМИ ИЗМЕНЕНИЯМИ.

Superfici

SURFACES/SURFACES/OBERFLÄCHEN/SUPERFICIES/ПоверхностиСимволы

Naturale / Matte / Mat / Matt / Mate / **Натуральная**

Superficie risultante dalla produzione di piastrella pressata senza lavorazioni successive alla cottura. / Surface coming from manufacturing pressed tiles without further work after firing. / Surface résultant de la production d'un carreau pressé sans être travaillé après la cuisson. / Die Oberfläche entsteht durch das Fliesenpressverfahren - im Anschluss an das Brennen erfolgt keine weitere Bearbeitung. / Superficie que resulta de la producción de baldosa prensada sin ulteriores elaboraciones después de la cocción. / **Поверхность, получаемая в результате производства прессованной плитки, без выполнения обработки после обжига.**

Strutturato / Structured / Structuré / Strukturiert / Estructurado / **Структурированный**

Superficie risultante dalla produzione di piastrella pressata, a tampono non liscio con intensità di evidenza variabile (da leggera ondulazione ad imitazione di pietra tagliata), senza lavorazioni successive alla cottura. / Surface coming from manufacturing pressed tiles, using a rough pad with variable intensity (from a slightly undulating one to inspired cut stone), without processing after firing. / Surface résultant de la production d'un carreau pressé, par un tampon à relief avec une intensité d'aspect variable (de légère ondulation à l'inspiration de la pierre taillée), sans être travaillé après la cuisson. / Die Oberfläche beruht auf dem Produktionsverfahren der Fliesenpressung unter Verwendung eines unglatten Stempels mit Intensitätsvariation (leichte Wellung entsprechend eines geschnittenen Steins). Es erfolgt keine Weiterbearbeitung nach dem Brennen. / Superficie que resulta de la producción de baldosa prensada, con tampon no liso con intensidad de evidencia variable (de ligera ondulación a imitación de piedra cortada), sin ulteriores elaboraciones después de la cocción. / **Поверхность, получаемая в результате производства прессованной плитки, с использованием негладкого тампона, с переменной заметностью (от легкой волнистости до имитации разрезанного камня), без выполнения обработки после обжига.**

Bocciardato / Bush-hammered / Bouchardé / Gehämmert / Abujardado / **Бучардная**

Superficie risultante dalla produzione di piastrella sottoposta, dopo la pressatura ma prima della cottura, a lavorazione meccanica consistente nell'asportazione irregolare di uno strato di materia per ottenere una superficie come per la pietra assolutamente naturale (antiscivolo), con leggere differenze non ripetibili tra una piastrella ed un'altra. / Surface coming from manufacturing tiles subjected to mechanical processing consisting of irregularly removing a layer of material after pressing but before firing in order to obtain a surface like absolutely pure natural stone (non slip), with slight unrepeatable differences between one tile and another. / Surface résultant de la production d'un carreau soumis, après le pressage mais avant la cuisson, à un travail mécanique qui consiste à éliminer de façon irrégulière une épaisseur de matière afin d'obtenir une surface semblable à la pierre naturelle tout à fait naturelle (anti-glisse), avec de légères différences variant d'un carreau à l'autre. / Zur Gewinnung dieser Oberfläche wurde die Fliese im Anschluss an die Pressung und vor dem Brennen einer mechanischen Bearbeitung zur Abtragung von Unregelmäßigkeiten einer Materialschicht unterzogen. Mit Hilfe dieses Verfahrens wird eine absolut natürliche und dem Naturstein entsprechende (rutschfeste) Oberfläche erzielt, die für geringfügige, aber einmalige Unterschiede unter den Fliesen verantwortlich ist. / Superficie que resulta de la producción de baldosa sometida, después del prensado pero antes de la cocción, a un proceso mecánico consistente en la eliminación irregular de una capa de materia para obtener una superficie como la piedra totalmente natural (resistente al deslizamiento), con ligeras diferencias que no se repiten entre una baldosa y otra. / **Поверхность, получаемая в результате производства плитки, подверженная после прессовки, но до обжига, механической обработке, заключающейся в неравномерном удалении слоя материала для получения натуральной поверхности, как у природного камня (нескользякой), с легкими, неповторимыми отличиями у изделий.**

High - Glossy

Finitura ottenuta sottoponendo la superficie non smaltata a lucidatura meccanica di media intensità dopo la cottura; la superficie finale è morbida, lucida e riflettente. / Finish obtained by subjecting the unglazed surface to medium intensity mechanical polishing after firing. The final surface is soft, glossy and reflective. / Finition obtenue en soumettant la surface non émaillée à un polissage mécanique d'intensité moyenne après cuisson; la surface finale est douce, brillante et réfléchissante. / Um das Finish zu erzielen, wird die unglasierte Oberfläche nach dem Brand einer mechanischen Politur von mittlerer Stärke unterzogen; die Oberfläche ist anschließend weich, poliert und reflektierend. / Acabado que se obtiene sometiendo la superficie no esmaltada al pulido mecánico de mediana intensidad tras la cocción; la superficie final es lisa, pulida y reflectante. / **эта отделка получается, подвергая обожженную неглазурованную поверхность механической полировке средней интенсивности. Готовая поверхность является мягкой, полированной и отражающей.**

Superficie R+PTV / R+PTV Surface / Surface R+PTV / Oberfläche R+PTV / Superficie R+PTV / **Поверхность R+PTV**

Superficie ottenuta dalla produzione di piastrella con tampono opportunamente sagomato così da raggiungere precise caratteristiche di sicurezza misurate secondo i principali metodi normativi in uso. La superficie finale è leggermente ruvida, opaca e conforme ai requisiti di scivolosità R10 (norma di riferimento DIN 51130) e scivolosità Pendolo >36 wet (slider 96, norma di riferimento BS 7976 -AS/NZS 4586).

Surface obtained from the production of tiles with appropriately shaped die in order to achieve precise safety characteristics measured based on the main prevailing regulatory methods in use. The final surface is slightly rough, matt and complies with R10 slipperiness requirements (reference standard DIN 51130) and Pendulum slipperiness >36 wet (slider 96, reference standard BS 7976 -AS/NZS 4586). / Surface obtenue à partir de la production de carreaux avec tampon opportunément façonné de manière à satisfaire des caractéristiques de sécurité précises, mesurées suivant les principales méthodes réglementaires en vigueur. La surface finale est légèrement rugueuse, mate et répond aux exigences de la classe de glissance R10 (norme de référence DIN 51130) et de glissance - test du pendule - humide - valeur >36 (slider 96, norme de référence BS 7976 -AS/NZS 4586). / Durch die Produktion von Fliesen mit entsprechend geformter Kachelunterlage erhaltene Oberfläche, um präzise Sicherheitscharakteristiken zu erzielen, gemessen nach den wichtigsten angewandten Regelungsmethoden. Die fertige Oberfläche ist leicht angeraut, matt und konform mit den rutschhemmenden Eigenschaft R10 (Bezugsnorm DIN 51130) und der Rutschfestigkeit Pendolo >36 wet (slider 96, Bezugsnorm BS 7976 -AS/NZS 4586). / Superficie obtenida de la producción de baldosas con un molde específicamente fabricado para alcanzar características precisas de seguridad de conformidad con los principales métodos normativos vigentes. La superficie final es ligeramente áspera, opaca y conforme a los requisitos de resistencia al deslizamiento R10 (norma de referencia DIN 51130) y resistencia al deslizamiento Péndulo >36 mojado (slider 96, norma de referencia BS 7976 -AS/NZS 4586). / **Эта поверхность создается во время производства плитки при помощи специального фасонного тампона, позволяющего получать точные характеристики безопасности, измеренные в соответствии с основными методами, предусмотренными стандартами. Конечная поверхность является слегка шершавой, матовой и соответствует требованиям сопротивления скольжению R10 (справочный стандарт - DIN 51130) и сопротивления скольжению методом маятника >36 в мокром состоянии (образец 96, справочный стандарт BS 7976 -AS/NZS 4586).**

Comfort

La nuova superficie Comfort è frutto dello storico know-how industriale della nostra azienda e rappresenta una vera e propria rivoluzione nell'utilizzo del prodotto ceramico. Comfort unisce il tatto morbido e piacevole delle finiture naturali con prestazioni tecniche sulla scivolosità (R10 classe B e PTV>36) che la rendono particolarmente indicata nelle applicazioni pubbliche e commerciali, anche in condizioni di umidità e bagnato. / The new Comfort surface is the outcome of our company's historic industrial know-how and represents a real revolution in the use of ceramic products. Comfort combines the soft, pleasant feel of a matte surface with anti-slip technical performances (R10 class B and PTV >36) that make it particularly suitable for public and commercial applications, including in wet and humid conditions. / La nouvelle surface Comfort est l'aboutissement de l'historique savoir-faire industriel de notre entreprise. Elle révolutionne littéralement l'emploi du produit céramique. Comfort allie le toucher doux et agréable des finitions naturelles aux performances techniques sur la glissance (R10 classe B et PTV >36). La surface est ainsi tout particulièrement indiquée dans les applications publiques et commerciales, y compris dans les lieux humides et mouillés. / Die neue Oberfläche Comfort basiert auf dem langjährigen produktionstechnischen Know-how unseres Unternehmens und steht für eine echte Revolution in der Verwendung keramischer Produkte. Comfort vereint die angenehm weiche Haptik einer natürlichen Oberfläche mit technischen Eigenschaften in punkto Rutschhemmung (R10 Klasse B und PTV>36), die das Produkt für den Einsatz in öffentlichen und gewerblichen Bereichen, und zwar auch bei Feuchtigkeit und Nässe, prädestinieren. La nueva superficie Comfort es fruto del histórico saber hacer industrial de nuestra empresa y representa una auténtica revolución en el uso del producto cerámico. Comfort aúna el tacto suave y agradable del acabado natural con unas prestaciones técnicas de resistencia al deslizamiento (R10 clase B y PTV>36) que la convierten en particularmente indicada para aplicaciones públicas y comerciales, incluso en condiciones de humedad y de mojado. / Новая поверхность Comfort была создана с применением промышленного ноу-хау, накопленного нашей компанией за долгие годы работы, и она представляет собой самую настоящую революцию в использовании керамики. Comfort объединяет в себе мягкое и приятное ощущение натуральной отделки с техническими характеристиками трения (R10 класс B и PTV>36), делающими эту отделку особенно подходящей в общественных и коммерческих объектах, даже при наличии влаги и воды.

Cannetè / Cannetè / Cannetè / Cannetè / Cannetè

Superficie risultante dalla produzione di piastrella pressata a tampone non liscio con rilievi geometrici regolari ad intensità crescente, senza lavorazioni successive alla cottura. / Surface resulting from the manufacturing of a tile pressed with a non-smooth pad featuring regular geometrical embossing with increasing intensity, with no further processing after firing. / Surface résultant de la production d'un carreau pressé par tampon non lisse, avec reliefs géométriques d'intensité croissante, sans usinage après la cuisson. / Die Oberflächen sind das Ergebnis des Produktionsverfahrens der Fliesenpressung unter Verwendung eines unglatten Stempels mit gleichmäßigen geometrischen Reliefs ohne eine Weiterbearbeitung nach dem Brennen. / Superficie risultante de la producción de azulejos prensados con tampones texturados, con relieves geométricos regulares de intensidad creciente, sin elaboraciones posteriores a la cocción. / Поверхность получается в результате прессования в пресс-форме не с гладкой внутренней поверхностью, а с постепенно увеличивающимися по размеру выпуклостями с регулярным геометрическим рисунком, без последующей обработке во время обжига.

Soft / Soft / Soft / Soft / Soft / Мягкая - Lucido / Shiny / Brillant / Glänzend / Brillante / Лянцевая

Superficie risultante dalla produzione di piastrella pressata, sottoposta a lavorazione meccanica di intensità intermedia, successiva alla cottura per dare alla superficie una finitura morbida e lievemente satinata, levigata ma non riflettente. / Surface coming from manufacturing pressed tiles, with a smooth or structured pad, subjected to intermediate intensity mechanical processing, with little removal of the material after firing to give the surface a smooth and slightly glazed finish, polished but not reflecting. / Surface résultant de la production d'un carreau pressé, par un tampon lisse ou structuré, soumis à un travail mécanique d'une intensité moyenne, avec une élimination minimale de matière après la cuisson, afin de donner à la surface une finition douce et légèrement satinée, polie mais non réfléchissante. / Die Oberfläche entsteht durch eine Fliesenpressung unter Verwendung eines glatten oder strukturierten Stempels. Die Fliese wird einer mittelschweren mechanischen Bearbeitung unterzogen, wobei im Anschluss an das Brennen eine minimale Materialmenge abgetragen wurde. Dies verleiht der Oberfläche ein weiches, leicht satinierendes, geschliffenes aber reflektionsfreies Finish. / Superficie que resulta de la producción de baldosa prensada, con tampón liso o estructurado, sometido a un proceso mecánico de intensidad intermedia, con mínima eliminación de materia, posterior a la cocción para dar a la superficie un acabado suave y levemente satinado, pulido pero no reflectante. / Поверхность, получаемая в результате производства прессованной плитки, с использованием гладкого или структурированного тампона, подверженная механической обработке после обжига средней интенсивности, с минимальным удалением материала, для придания поверхности мягкой, слегка сатирированной отделки, шлифованной, не отражающей свет.

Glossy-bright

Glossy - Bright è l'innovativa superficie lucida di Florim che valorizza il materiale full body di cui la lastra è composta. Questa finitura conferisce un'elevata profondità estetica ricordando l'effetto tipico dei prodotti levigati e garantendo performance tecniche ad essi assimilabili. Glossy - Bright, infatti, unisce brillantezza ed eccellenti caratteristiche di resistenza all'usura, raramente riscontrabili in un materiale dall'effetto lucido. / Glossy - Bright is Florim's innovative shiny surface that enhances the full body material used to make the slab. This surface has an effect of particular depth, evoking the typical appearance of polished products and delivering technical performances very similar to these. In fact, Glossy - Bright combines brilliance and excellent wear resistance, qualities rarely found in a material with a glossy effect. / Glossy - Bright est l'incroyable surface brillante de Florim qui met en valeur le matériau pleine masse de la dalle. Cette finition donne plus de profondeur esthétique et évoque l'effet typique des produits polis, tout en garantissant des performances techniques similaires. Glossy - Bright allie, en effet, brillance et excellente résistance à l'usure, ce que l'on trouve rarement dans un matériau effet shiny. / Glossy - Bright, die innovative glänzende Oberfläche von Florim, die dem Plattenmaterial eine wertige Ausstrahlung verleiht. Die Beschaffenheit der Oberfläche schafft mehr Tiefe und erinnert an den typischen Effekt polierter Produkte und bietet gleichzeitig eine mit diesen Produkten vergleichbare technische Performance. Glossy - Bright verbindet in der Tat Brillanz mit hoher Verschleißfestigkeit, die in einem Material mit Glanzoptik selten zu finden ist. / Glossy - Bright es la innovadora superficie brillante de Florim que valoriza la propia materia con la que está hecha la placa. Este acabado confiere una elevada profundidad estética remitiendo al efecto típico de los productos pulidos y garantizando unas prestaciones técnicas asimilables a los mismos. Glossy - Bright, aúna brillo y unas excelentes características de resistencia al desgaste, propiedades insólitas en un material de aspecto brillante. / Glossy - Bright – это инновационная полированная поверхность от Florim, подчеркивающая красоту окрашенного в массу материала, из которого состоит плита. Эта отделка придает более выраженный эффект глубины и напоминает характерный вид полированных изделий, гарантируя сходные с ними технические свойства. Glossy - Bright объединяет блеск с великолепными показателями износостойкости, редко встречающимися у полированного материала.

Tabella Imballi

PACKAGE TABLE - TABLEAU DE EMBALLAGES - TABELLE FORMATE - TABLA DE LOS EMBALAJES - Таблица упаковок

	scatola - box			pallet		
	pz	mq	kg	box	mq	kg

imballi per scatola
packages for boxes
emballages pour boîte
verpackungen für schachteln
embalajes para cajas
Упаковки на коробку

imballi per pallet
packages for pallets
emballages pour palette
verpackungen für paletts
embalajes para paletas
Упаковки на поддон

Tabella gruppi di prezzo

TABLE OF PRICE RANGES - TABLEAU GROUPE DES PRIX - TABELLE PREISGRUPPEN - TABLA DE GRUPO DE PRECIOS - Таблица ценовых групп

Descrizione simboli / Description of symbols / Description symboles / Zeichenerklärung / Descripción de los símbolos / Описание символов			
			
<p>PREZZO PER MATERIALE GESTITO A METRO QUADRO</p> <p>Price for materials managed per square metre. Prix pour matériau géré au mètre carré Materialpreis pro Quadratmeter Precio del material por metro cuadrado Цена за материал, реализуемый квадратными метрами</p>	<p>*PREZZO PER MATERIALE GESTITO A PEZZO</p> <p>Price for materials managed per piece Prix pour matériau géré à la pièce Materialpreis pro Stück Precio del material por pieza Цена за материал, реализуемый поштучно</p>	<p>PREZZO PER MATERIALE GESTITO A NUMERO/COMPOSIZIONE</p> <p>Price for materials managed per number/composition Prix pour matériau géré à nombre/composition Materialpreis pro Anzahl/zusammenstellung Precio del material por número/composición Цена за материал, реализуемый комплектами/композициями</p>	<p>PREZZO PER MATERIALE GESTITO A METRO LINEARE</p> <p>Price for materials managed lm Prix pour matériau géré à mètre linéaire Materialpreis pro Lfm Precio del material por ml Цена за композицию</p>
<p>*costo al pezzo, vendita a scatola completa price per piece, sold by full boxes only • prix à la pièce, vente à la boîte complète • stückpreis bei voller kartonabnahme • precio à la pieza, venta à caja completata • Стоимость одной штуки, продаются целыми коробками</p>			



AIRTECH

gres fine porcellanato
fine porcelain stoneware
grès cérame fin
feinsteinzeug-kollektionen
gres porcelánico fino
фарфоровый керамогранит





AIRTECH

La continua evoluzione architettonica e i nuovi stili di vita sono sempre più orientati alla ricerca di ambienti osmotici in cui il dentro sconfini nel fuori con una informalità naturale. Per questo diventa necessario trovare una superficie fluida adatta alla creazione di luoghi che dialoghino tra loro in modo uniforme e discreto. **Airtech** è stata pensata per integrarsi in tutti gli spazi in cui il proprio istinto progettuale possa lasciare un segno distintivo. Un sistema completo di superfici, colori e formati definiscono potenzialità inattese.

The constant evolution of architecture and our new lifestyles have led more and more towards the search for osmotic environments where the inside encroaches on the outside spaces with a natural informality. This is why it becomes necessary to find a fluid surface suitable for creating places that will dialogue with each other uniformly and discreetly. **Airtech** has been devised to integrate into all spaces in which one's instinct for design can leave a distinctive mark. A complete system of surface finishes, colours and sizes highlight unexpected potentialities.

L'évolution architecturale constante et les nouveaux styles de vie sont de plus en plus orientés vers la recherche d'espaces osmotiques où l'intérieur empiète sur l'extérieur avec une informalité naturelle. Il devient ainsi nécessaire de trouver une surface fluide adaptée à la création de lieux en mesure de dialoguer entre eux de façon uniforme et discrète. La série **Airtech** a été conçue pour s'adapter à tous les espaces pouvant se distinguer par l'instinct de l'architecte. Un système complet de surfaces, de couleurs et de formats qui définissent des potentialités surprenantes.

Die kontinuierliche Entwicklung in der Architektur und die neuen Lebensstile orientieren sich mehr und mehr an der Suche nach einem osmotischen Ambiente, in dem das Innere mit einer natürlichen Informalität an das Äußere grenzt. Aus diesem Grund ist es notwendig, eine fließende Oberfläche für die Gestaltung von Räumen zu finden, die auf einheitliche und diskrete Weise miteinander kommunizieren. **Airtech** wurde entwickelt, um in allen Räumlichkeiten zu passen, in denen der Designinstinkt eine unverwechselbare Note hinterlassen kann. Ein komplettes System von Oberflächen, Farben und Formaten definiert ein unerwartetes Potenzial.

La continua evolución arquitectónica y los nuevos estilos de vida están cada vez más orientados a la investigación de ambientes osmóticos en los que el interior invade el exterior con una informalidad natural y, precisamente por eso, encontrar una superficie fluida que se adapte a la creación de lugares que dialoguen entre sí de forma homogénea y discreta se convierte en una necesidad. **Airtech** se ha pensado para integrarse en todos los espacios en los que el propio instinto de diseño pueda dejar una marca distintiva. Un sistema completo de superficies, colores y formatos definen potencialidades inesperadas.

Постоянная эволюция архитектурных стилей и меняющийся образ жизни все больше ориентируются на поиск взаимопроницающих интерьеров, где с непосредственной естественностью размываются внутренние и внешние границы. Поэтому возникает необходимость найти «текучую» поверхность, подходящую для создания помещений, плавно и ненавязчиво переходящих одно в другое. Коллекция **Airtech** была задумана для интеграции во все те интерьеры, где ее интуитивный дизайн может оставить свой особый отпечаток. Это целая система фактур, цветов и форматов, позволяющих находить самые неожиданные решения.

AIRTECH

MIAMI_WHITE



R9
Classe B
(naturale)

R11
Classe C
(strutturato)

DCOF>
0,42 Wet
(naturale/
strutturato)

10 mm 3/8" ↑↓



R11
Classe C
(strutturato)

DCOF>
0,42 Wet

20 mm 3/4" ↑↓

GRES FINE PORCELLANATO

FINE PORCELAIN STONEWARE / GRÈS CÉRAME FIN / FEINSTEINZEUG-KOLLEKTIONEN / GRES PORCELÁNICO FINO / фарфоровый керамогранит

SQUADRATO - SQUARED - EQUARRI - REKTIFIZIERT - ESCUADRADO - КАЛИБРОВАННА

10 mm 3/8" ↑↓	COLOR	SURFACE	60x120 23 ^{5/8"} x47 ^{1/4"}	80x80 31 ^{1/2"} x31 ^{1/2"}	40x80 15 ^{3/4"} x31 ^{1/2"}	60x60 23 ^{5/8"} x23 ^{5/8"}	30x60 11 ^{4/5"} x23 ^{5/8"}	20x20 7 ^{7/8"} x7 ^{7/8"}
AIRTECH	MIAMI_WHITE	NATURALE	760279 ■ FL-09100	760273 ■ FL-08100	760261 ■ FL-05800	760249 ■ FL-05800	760243 ■ FL-04900	-
		HIGH-GLOSSY	760285 ■ FL-10500	-	-	-	-	-
		STRUTTURATO	-	-	760267 ■ FL-05800	760255 ■ FL-05800	762197 ■ FL-04900	760237 ■ FL-07000

GRES FINE PORCELLANATO

FINE PORCELAIN STONEWARE / GRÈS CÉRAME FIN / FEINSTEINZEUG-KOLLEKTIONEN / GRES PORCELÁNICO FINO / фарфоровый керамогранит

20 mm 3/4" ↑↓	COLOR	SURFACE	20,2x30,4 8"x12"	20,2x20,2 8"x8"
AIRTECH	MIAMI_WHITE	STRUTTURATO	758199 ■ FL-10800	758193 ■ FL-10800

NEW YORK_LIGHT GREY



V3
R9
Classe B
 (naturale)

R11
Classe C
 (strutturato)

DCOF>
 0,42 Wet
 (naturale/
 strutturato)

10 mm 3/8" ↑↓

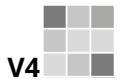

V4
R11
Classe C
 (strutturato)

DCOF>
 0,42 Wet

20 mm 3/4" ↑↓

GRES FINE PORCELLANATO

FINE PORCELAIN STONEWARE / GRÈS CÉRAME FIN / FEINSTEINZEUG-KOLLEKTIONEN / GRES PORCELÁNICO FINO / фарфоровый керамогранит
 SQUADRATO - SQUARED - EQUARRI - REKTIFIZIERT - ESCUADRADO - КАЛИБРОВАННА

10 mm 3/8" ↑↓	COLOR	SURFACE	60x120 23 ^{5/8"} x47 ^{1/4"}	80x80 31 ^{1/2"} x31 ^{1/2"}	40x80 15 ^{3/4"} x31 ^{1/2"}	60x60 23 ^{5/8"} x23 ^{5/8"}	30x60 11 ^{4/5"} x23 ^{5/8"}	20x20 7 ^{7/8"} x7 ^{7/8"}
	NEW YORK_LIGHT GREY	NATURALE	760276 ■ FL-09100	760270 ■ FL-08100	760258 ■ FL-05800	760246 ■ FL-05800	760240 ■ FL-04900	-
		GLOSSY-BRIGHT	760282 ■ FL-10500	-	-	-	-	-
		STRUTTURATO	-	-	760264 ■ FL-05800	760252 ■ FL-05800	762194 ■ FL-04900	760234 ■ FL-07000

GRES FINE PORCELLANATO

FINE PORCELAIN STONEWARE / GRÈS CÉRAME FIN / FEINSTEINZEUG-KOLLEKTIONEN / GRES PORCELÁNICO FINO / фарфоровый керамогранит

20 mm 3/4" ↑↓	COLOR	SURFACE	20,2x30,4 8"x12"	20,2x20,2 8"x8"
AIRTECH	NEW YORK_LIGHT GREY	STRUTTURATO	758196 ■ FL-10800	758190 ■ FL-10800

AIRTECH # 20 MM - 20,2x20,2 / 20,2x30,4
 Materiale non esattamente calibrato; prevedere fuga da 3 a 7 mm.
 Calibration of this product is not exact, please consider a 3 to 7 mm joint.
 Matériel non calibré de manière précise ; prévoir un joint de 3 à 7 mm.
 Nicht exakt rektifiziertes Material, es muss eine Fuge von 3-7mm vorgesehen werden.
 Material no exactamente calibrado; prever una junta de 3 a 7mm.
 Материал не строго откалиброван; предусматривается шов от 3 до 7 мм.

STOCKHOLM_GREIGE

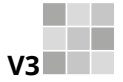

V3
R9
Classe B
 (naturale)

R11
Classe C
 (strutturato)

DCOF>
 0,42 Wet
 (naturale/
 strutturato)

10 mm 3/8" ↑↓



V4
R11
Classe C
 (strutturato)

DCOF>
 0,42 Wet

20 mm 3/4" ↑↓

GRES FINE PORCELLANATO

FINE PORCELAIN STONEWARE / GRÈS CÉRAME FIN / FEINSTEINZEUG-KOLLEKTIONEN / GRES PORCELÁNICO FINO / фарфоровый керамогранит

SQUADRATO - SQUARED - EQUARRI - REKTIFIZIERT - ESCUADRADO - КАЛИБРОВАННА

10 mm 3/8" ↑↓	COLOR	SURFACE	60x120 23 ^{5/8"} x47 ^{1/4"}	80x80 31 ^{1/2"} x31 ^{1/2"}	40x80 15 ^{3/4"} x31 ^{1/2"}	60x60 23 ^{5/8"} x23 ^{5/8"}	30x60 11 ^{4/5"} x23 ^{5/8"}	20x20 7 ^{7/8"} x7 ^{7/8"}
AIRTECH	STOCKHOLM_GREIGE	NATURALE	760281 ■ FL-09100	760275 ■ FL-08100	760263 ■ FL-05800	760251 ■ FL-05800	760245 ■ FL-04900	-
		HIGH-GLOSSY	760287 ■ FL-10500	-	-	-	-	-
		STRUTTURATO	-	-	760269 ■ FL-05800	760257 ■ FL-05800	762199 ■ FL-04900	760239 ■ FL-07000

GRES FINE PORCELLANATO

FINE PORCELAIN STONEWARE / GRÈS CÉRAME FIN / FEINSTEINZEUG-KOLLEKTIONEN / GRES PORCELÁNICO FINO / фарфоровый керамогранит

20 mm 3/4" ↑↓	COLOR	SURFACE	20,2x30,4 8"x12"	20,2x20,2 8"x8"
AIRTECH	STOCKHOLM_GREIGE	STRUTTURATO	758201 ■ FL-10800	758195 ■ FL-10800

LONDON_BLACK



V3
R9
Classe B
 (naturale)

R11
Classe C
 (strutturato)

DCOF>
 0,42 Wet
 (naturale/
 strutturato)

10 mm 3/8" ↑↓

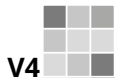

V4
R11
Classe C
 (strutturato)

DCOF>
 0,42 Wet

20 mm 3/4" ↑↓

GRES FINE PORCELLANATO

FINE PORCELAIN STONEWARE / GRÈS CÉRAME FIN / FEINSTEINZEUG-KOLLEKTIONEN / GRES PORCELÁNICO FINO / фарфоровый керамогранит
 SQUADRATO - SQUARED - EQUARRI - REKTIFIZIERT - ESCUADRADO - КАЛИБРОВАННА

10 mm 3/8" ↑↓	COLOR	SURFACE	60x120 23 ^{5/8"} x47 ^{1/4"}	80x80 31 ^{1/2"} x31 ^{1/2"}	40x80 15 ^{3/4"} x31 ^{1/2"}	60x60 23 ^{5/8"} x23 ^{5/8"}	30x60 11 ^{4/5"} x23 ^{5/8"}	20x20 7 ^{7/8"} x7 ^{7/8"}
	LONDON_BLACK	NATURALE	760278 ■ FL-09100	760272 ■ FL-08100	760260 ■ FL-05800	760248 ■ FL-05800	760242 ■ FL-04900	-
		GLOSSY-BRIGHT	760284 ■ FL-10500	-	-	-	-	-
		STRUTTURATO	-	-	760266 ■ FL-05800	760254 ■ FL-05800	762196 ■ FL-04900	760236 ■ FL-07000

GRES FINE PORCELLANATO

FINE PORCELAIN STONEWARE / GRÈS CÉRAME FIN / FEINSTEINZEUG-KOLLEKTIONEN / GRES PORCELÁNICO FINO / фарфоровый керамогранит

20 mm 3/4" ↑↓	COLOR	SURFACE	20,2x30,4 8"x12"	20,2x20,2 8"x8"
	LONDON_BLACK	STRUTTURATO	758198 ■ FL-10800	758192 ■ FL-10800

AIRTECH # 20 MM - 20,2x20,2 / 20,2x30,4
 Materiale non esattamente calibrato; prevedere fuga da 3 a 7 mm.
 Calibration of this product is not exact, please consider a 3 to 7 mm joint.
 Matériel non calibré de manière précise; prévoir un joint de 3 à 7 mm.
 Nicht exakt rektifiziertes Material, es muss eine Fuge von 3-7mm vorgesehen werden.
 Material no exactamente calibrado; prever una junta de 3 a 7mm.
 Материал не строго откалиброван; предусматривается шов от 3 до 7 мм.

AIRTECH

BASEL_GREY



V3
R9
Classe B
 (naturale)

R11
Classe C
 (strutturato)

DCOF>
 0,42 Wet
 (naturale/
 strutturato)

10 mm 3/8" ↑↓



V4
R11
Classe C
 (strutturato)

DCOF>
 0,42 Wet

20 mm 3/4" ↑↓

GRES FINE PORCELLANATO

FINE PORCELAIN STONEWARE / GRÈS CÉRAME FIN / FEINSTEINZEUG-KOLLEKTIONEN / GRES PORCELÁNICO FINO / фарфоровый керамогранит

SQUADRATO - SQUARED - EQUARRI - REKTIFIZIERT - ESCUADRADO - КАЛИБРОВАННА

10 mm 3/8" ↑↓	COLOR	SURFACE	60x120 23 ^{5/8"} x47 ^{1/4"}	80x80 31 ^{1/2"} x31 ^{1/2"}	40x80 15 ^{3/4"} x31 ^{1/2"}	60x60 23 ^{5/8"} x23 ^{5/8"}	30x60 11 ^{4/5"} x23 ^{5/8"}	20x20 7 ^{7/8"} x7 ^{7/8"}
AIRTECH	BASEL_GREY	NATURALE	760280 ■ FL-09100	760274 ■ FL-08100	760262 ■ FL-05800	760250 ■ FL-05800	760244 ■ FL-04900	-
		HIGH-GLOSSY	760286 ■ FL-10500	-	-	-	-	-
		STRUTTURATO	-	-	760268 ■ FL-05800	760256 ■ FL-05800	762198 ■ FL-04900	760238 ■ FL-07000

GRES FINE PORCELLANATO

FINE PORCELAIN STONEWARE / GRÈS CÉRAME FIN / FEINSTEINZEUG-KOLLEKTIONEN / GRES PORCELÁNICO FINO / фарфоровый керамогранит

20 mm 3/4" ↑↓	COLOR	SURFACE	20,2x30,4 8"x12"	20,2x20,2 8"x8"
AIRTECH	BASEL_GREY	STRUTTURATO	758200 ■ FL-10800	758194 ■ FL-10800

BERLIN_RED



V3
R9
Classe B
 (naturale)

R11
Classe C
 (strutturato)

DCOF>
 0,42 Wet
 (naturale/
 strutturato)

10 mm 3/8" ↑↓



V4
R11
Classe C
 (strutturato)

DCOF>
 0,42 Wet

20 mm 3/4" ↑↓

GRES FINE PORCELLANATO

FINE PORCELAIN STONEWARE / GRÈS CÉRAME FIN / FEINSTEINZEUG-KOLLEKTIONEN / GRES PORCELÁNICO FINO / фарфоровый керамогранит

SQUADRATO - SQUARED - EQUARRI - REKTIFIZIERT - ESCUADRADO - КАЛИБРОВАННА

10 mm 3/8" ↑↓	COLOR	SURFACE	60x120 23 ^{5/8"} x47 ^{1/4"}	80x80 31 ^{1/2"} x31 ^{1/2"}	40x80 15 ^{3/4"} x31 ^{1/2"}	60x60 23 ^{5/8"} x23 ^{5/8"}	30x60 11 ^{4/5"} x23 ^{5/8"}	20x20 7 ^{7/8"} x7 ^{7/8"}
	BERLIN_RED	NATURALE	760277 ■ FL-09100	760271 ■ FL-08100	760259 ■ FL-05800	760247 ■ FL-05800	760241 ■ FL-04900	-
		GLOSSY-BRIGHT	760283 ■ FL-10500	-	-	-	-	-
		STRUTTURATO	-	-	760265 ■ FL-05800	760253 ■ FL-05800	762195 ■ FL-04900	760235 ■ FL-07000

GRES FINE PORCELLANATO

FINE PORCELAIN STONEWARE / GRÈS CÉRAME FIN / FEINSTEINZEUG-KOLLEKTIONEN / GRES PORCELÁNICO FINO / фарфоровый керамогранит

20 mm 3/4" ↑↓	COLOR	SURFACE	20,2x30,4 8"x12"	20,2x20,2 8"x8"
AIRTECH	BERLIN_RED	STRUTTURATO	758197 ■ FL-10800	758191 ■ FL-10800

20 mm 3/4" ↑↓







Product Certification
BUREAU VERITAS
 Certification

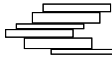

Recycled material content certification

AIRTECH # 20 MM - 20,2x20,2 / 20,2x30,4
 Materiale non esattamente calibrato; prevedere fuga da 3 a 7 mm.
 Calibration of this product is not exact, please consider a 3 to 7 mm joint.
 Matériel non calibré de manière précise ; prévoir un joint de 3 à 7 mm.
 Nicht exakt rektifiziertes Material, es muss eine Fuge von 3-7mm vorgesehen werden.
 Material no exactamente calibrado; prever una junta de 3 a 7mm.
 Материал не строго откалиброван; предусматривается шов от 3 до 7 мм.

AIRTECH









10 mm 3/8" ↑↓				30x30 11 ^{4/5} "x11 ^{4/5} "  mosaico tessere 3x3 pz/box 11	21x40 8 ^{1/4} "x15 ^{3/4} "  listello sfalsato
	COLOR	SURFACE			
AIRTECH		NATURALE	761048 ▲ FL-02000	761036 ■ FL-17200	
		HIGH-GLOSSY	761042 ▲ FL-02300	761030 ■ FL-21000	
		NATURALE	761049 ▲ FL-02000	761037 ■ FL-17200	
		HIGH-GLOSSY	761043 ▲ FL-02300	761031 ■ FL-21000	
		NATURALE	761050 ▲ FL-02000	761038 ■ FL-17200	
		HIGH-GLOSSY	761044 ▲ FL-02300	761032 ■ FL-21000	
		NATURALE	761047 ▲ FL-02000	761035 ■ FL-17200	
		HIGH-GLOSSY	761041 ▲ FL-02300	761029 ■ FL-21000	
		NATURALE	761045 ▲ FL-02000	761033 ■ FL-17200	
		HIGH-GLOSSY	761039 ▲ FL-02300	760907 ■ FL-21000	
		NATURALE	761046 ▲ FL-02000	761034 ■ FL-17200	
		HIGH-GLOSSY	761040 ▲ FL-02300	761028 ■ FL-21000	

Per un effetto ottimale della posa, florim suggerisce di mantenere 2 mm di fuga per pose monofornato e 3 mm per combinare formati misti - For optimal installation results, florim recommends maintaining a joint of 2 mm 1/12" for single format installations and 3 mm 1/8" to combine mixed formats. - Pour réaliser une pose parfaite, florim suggère de maintenir 2 mm de joint pour la pose des monofornats, et 3 mm pour les combinaisons de formats mixtes. - Um einen optimalen effekt beim verlegen zu erzielen empfiehlt florim eine 2 mm fuge bei einformatigen verlegungen und 3 mm fuge bei formatkombinationen Para lograr los máximos resultados en la posa del producto, florim aconseja 2 mm de junta en aplicaciones monofornato y 3 mm en combinaciones de formatos mixtos - ДЛЯ ОПТИМАЛЬНОЙ УКЛАДКИ * FLORIM * РЕКОМЕНДУЕТ ВЫДЕРЖИВАТЬ ЗАЗОР 2 ММ ДЛЯ МОНОФОРМАТА И 3 ММ ПРИ СМЕШАННЫХ ФОРМАТАХ.

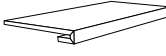
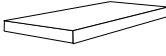
Architectural design

PEZZI SPECIALI/SPECIAL TRIMS/PIÈCES SPÉCIALES/FORMSTÜCKE/PIEZAS ESPECIALES/Специальные изделия

10 mm 3/8" ↑↓

	COLOR	SURFACE	4,6x60 1 ^{45/64} "x2 ^{5/8} "  battiscopa	33x120x3 13"x47 ^{1/4} "x1 ^{1/8} "  angolo gradino DX pz/box 2	33x120x3 13"x47 ^{1/4} "x1 ^{1/8} "  gradino pz/box 2	33x120x3 13"x47 ^{1/4} "x1 ^{1/8} "  angolo gradino SX pz/box 2
AIRTECH	 MIAMI_WHITE	NATURALE	761078 ◆ FL-01600	761054 ▲ FL-31100	761066 ▲ FL-20400	761060 ▲ FL-31100
		HIGH-GLOSSY	761072 ◆ FL-01600	-	-	-
	 NEW YORK_LIGHT GREY	NATURALE	761079 ◆ FL-01600	761055 ▲ FL-31100	761067 ▲ FL-20400	761061 ▲ FL-31100
		HIGH-GLOSSY	761073 ◆ FL-01600	-	-	-
	 STOCKHOLM_GREIGE	NATURALE	761080 ◆ FL-01600	761056 ▲ FL-31100	761068 ▲ FL-20400	761062 ▲ FL-31100
		HIGH-GLOSSY	761074 ◆ FL-01600	-	-	-
	 LONDON_BLACK	NATURALE	761077 ◆ FL-01600	761053 ▲ FL-31100	761065 ▲ FL-20400	761059 ▲ FL-31100
		HIGH-GLOSSY	761071 ◆ FL-01600	-	-	-
	 BASEL_GREY	NATURALE	761075 ◆ FL-01600	761051 ▲ FL-31100	761063 ▲ FL-20400	761057 ▲ FL-31100
		HIGH-GLOSSY	761069 ◆ FL-01600	-	-	-
	 BERLIN_RED	NATURALE	761076 ◆ FL-01600	761052 ▲ FL-31100	761064 ▲ FL-20400	761058 ▲ FL-31100
		HIGH-GLOSSY	761070 ◆ FL-01600	-	-	-

AIRTECH	scatola - box			pallet		
	pz	mq	kg	box	mq	kg
60x120	2	1,44	32,10	30	43,20	990
80x80	2	1,28	29,80	40	51,20	1220
40x80	3	0,96	22,00	56	53,76	1260
60x60	3	1,08	24,10	40	43,20	990
30x60	6	1,08	24,10	40	43,20	990
20x20	24	0,96	21,40	54	51,84	1180

AIRTECH	scatola - box			pallet		
	pz	ml	kg	box	mq	kg
4,6x60 battiscopa	14	8,40	8,40	-	-	-

AIRTECH OUTDOOR

Vantaggi tecnici - Technical advantages - Avantages techniques Technische Vorteile - Ventajas técnicas - Технические преимущества

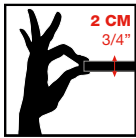

- Lastra monolitica compatta di spessore 2 cm squadrata e rettificata
- Compact monolithic slab 2 cm thick squared and rectified
- Dalle monolithique compacte de 2 cm d'épaisseur, équaree et rectifiée
- Kompakte monolithische Platte, 2 cm dick, rechteckig und scharfkantig geschliffen
- Losa monolítica compacta de 2 cm de espesor, escuadrada y rectificada.
- Монолитная плотная плита толщиной 2 см, с обрезанными и выровненными кромками

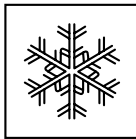

- INGELIVO
- FROST RESISTANT
- INGÉLIF
- FROSTBESTÄNDIG
- RESISTENTE A LA HELADA
- МОРОЗОСТОЙКАЯ

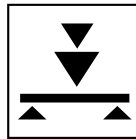

- ELEVATA RESISTENZA AI CARICHI STATICI
- HIGH STATIC LOAD RESISTANCE
- RÉSISTANCE ÉLEVÉE AUX CHARGES STATIQUES
- HOHE STATISCHE BELASTBARKEIT
- ELEVADA RESISTENCIA A LAS CARGAS ESTÁTICAS
- ВЫДЕРЖИВАЕТ БОЛЬШИЕ СТАТИЧЕСКИЕ НАГРУЗКИ

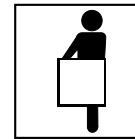

- FACILE DA POSARE
- EASY TO INSTALL
- FACILE À POSER
- VERLEGELEICHT
- FÁCIL DE COLOCAR
- ЛЕГКО УКЛАДЫВАЕТСЯ



- ANTISCIVOLO R11
- ANTI SLIP R11
- ANTIDÉRAPANT R11
- RUTSCHFEST R11
- ANTIDESLIZANTE R11
- НЕСКОЛЬЗКАЯ - R11

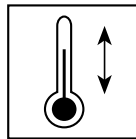

- RESISTENTE AGLI SBALZI TERMICI
- THERMAL SHOCK RESISTANT
- RÉSISTANT AUX ÉCARTS THERMIQUES
- TEMPERATURWECHSELBESTÄNDIG
- RESISTENTE A LAS OSCILACIONES TÉRMICAS
- СТОЙКАЯ К ТЕПЛОВЫМ ПЕРЕПАДАМ



- FACILE DA PULIRE
- EASY TO CLEAN
- FACILE À NETTOYER
- REINIGUNGSLEICHT
- FÁCIL DE LIMPIAR
- ЛЕГКО ЧИСТИТСЯ

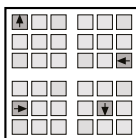

- RIMOVIBILE E RIUTILIZZABILE
- REMOVABLE AND REUSABLE
- DÉMONTABLE ET RÉUTILISABLE
- ENTFERNBAR UND WIEDERVERWENDBAR
- DESMONTABLE Y REUTILIZABLE
- МОЖЕТ СНИМАТЬСЯ И ПОВТОРНО ИСПОЛЬЗОВАТЬСЯ



- INATTACCABILE DA AGENTI CHIMICI E MUFFE
- IMPERVIOUS TO ATTACK BY CHEMICALS OR MOULD
- RÉSISTANT AUX AGENTS CHIMIQUES ET AUX MOISSISSURES
- UNANGREIFBAR DURCH CHEMISCHE STOFFE UND SCHIMMEL
- RESISTENTE A LOS AGENTES QUÍMICOS Y A LOS MOHOS
- НЕ ПОДВЕРГАЕТСЯ ВОЗДЕЙСТВИЮ ХИМИЧЕСКИХ ВЕЩЕСТВ И ПЛЕСЕНИ

Applicazioni - Applications - Applications - Verlegung - Aplicaciones - Применения

- Posa diretta su erba
- Direct installation on grass
- Pose direct sur de l'herbe
- Verlegung direkt auf Rasen
- Colocación directa sobre hierba
- Прямая укладка на траву



- Posa diretta su ghiaia
- Direct installation over gravel
- Pose direct sur du gravier
- Verlegung direkt auf Kies
- Colocación directa sobre grava
- Прямая укладка на гальку



- Posa su massetto cementizio
- Installation on sand-cement screed
- Pose sur chape ciment
- Verlegung auf Zement-Unterbetonblock
- Colocación sobre contrapiso de hormigón
- Укладка на цементную стяжку

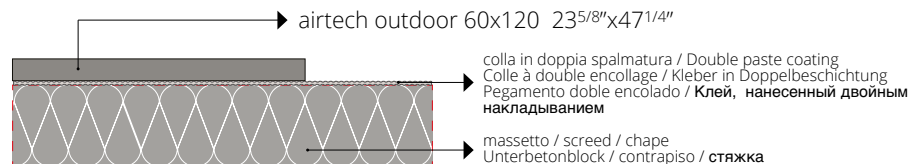

- Posa su piedini fissi o regolabili
- Installation on fixed or adjustable feet
- Pose sur pieds fixes ou réglables
- Verlegung auf feststehende oder regulierbare Füße
- Colocación sobre pies fijos o regulables
- Укладка на фиксированных или регулируемых ножках

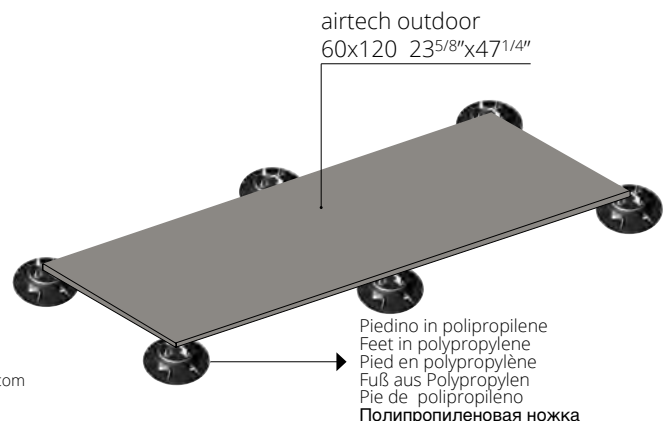

Per le specifiche di utilizzo dei sistemi sopraelevati vedi il sito florim.com
For the specifics on use of raised systems visit the site florim.com
Pour les caractéristiques d'utilisation des systèmes surélevés, voir le site florim.com
Für die Nutzungsbedingungen der Doppelbodensysteme siehe Webseite florim.com
Para las especificaciones de empleo de los sistemas sobreelevados consulte el sitio web florim.com
Технические характеристики систем фальшполов см. на сайте florim.com

Le lastre ceramiche sono sottoposte a un trattamento di compattazione termica che assicura resistenza e durata nel tempo. Il bassissimo assorbimento d'acqua rende perciò il materiale ingelivo. Ciò può comportare ristagni d'acqua superficiali anche per materiale installato a regola d'arte. / Ceramic tiles undergo a compacting thermal treatment that ensures resistance and durability. The low level of water absorption makes the slabs frost resistant. This could result in superficial water stagnations even if materials are installed in a workmanlike manner. / Les carreaux de céramique subissent un traitement thermique qui assure résistance et durabilité. Le bas niveau d'absorption d'eau rend les dalles résistant au gel. Il pourrait en résulter des stagnations d'eau superficielles, même si les dalles ont été installées dans les règles de l'art. / Die Keramikplatten werden einer thermischen Verdichtung unterzogen, welche die Widerstandsfähigkeit und Langlebigkeit sichert. Die extrem niedrige Wasseraufnahme macht das Material frostsicher. Die hohe Materialdichte kann, auch bei einer perfekten Verlegung, eine längere Abtrocknungszeit von angestaubtem Wasser zur Folge haben. / Las baldosas cerámicas se someten a un tratamiento de compactación térmica que asegura resistencia y durabilidad. La baja absorción de agua hace que las baldosas resistan al hielo. Esto podría resultar en estancamientos superficiales de agua, incluso si los materiales están instalados según las reglas del arte. / Керамическая плитка подвергается термическому уплотнению, что обеспечивает ей прочность и износостойкость. За счёт очень низкого водопоглощения она не промерзает, при этом даже при правильной укладке возможны застои воды на поверхности плитки.

MIAMI_WHITE



STOCKHOLM_GREIGE

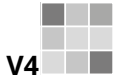

R11
CLASSE C

DCOF >
0,42 Wet

20 mm 3/4" ↑↓

BASEL_GREY



GRES FINE PORCELLANATO

FINE PORCELAIN STONEWARE/GRES CERAME FIN/FEINSTEINZEUG-KOLLEKTIONEN/GRES PORCELLANICO FINO/ФАРФОРОВЫЙ КЕРАМОГРАНИТ
SQUADRATO - SQUARED - EQUARRI - REKTIFIZIERT - ESCUADRADO - КАЛИБРОВАННАЯ

20 mm 3/4" ↑↓

	COLOR	SURFACE	60x120 23 ⁵ / ₈ "x47 ¹ / ₄ "	60x60 23 ⁵ / ₈ "x23 ⁵ / ₈ "
AIRTECH	MIAMI_WHITE	STRUTTURATO	761418 ■ FL-11300	761414 ■ FL-09300
	STOCKHOLM_GREIGE	STRUTTURATO	761420 ■ FL-11300	761416 ■ FL-09300
	BASEL_GREY	STRUTTURATO	761419 ■ FL-11300	761415 ■ FL-09300

PEZZI SPECIALI

Special trims/Pièces spéciales/Formstücke
Piezas especiales/СПЕЦИАЛЬНЫЕ ИЗДЕЛИЯ
pag 166/169

	RESISTENZA ALLA FLESSIONE IN N/mm² N/mm ² FLEXURAL STRENGTH TEST / RESISTANCE A LA FLEXION EN N/mm ² / BIEGEFESTIGKEIT IN N/mm ² / RESISTENCIA A LA FLEXION EN N/mm ² / УСТОЙЧИВОСТЬ К ИЗГИБУ В Н/мм ²	valore medio 52 N/mm²
	Forza di rottura in N (sp. > 7,5 mm) Breaking strength in N (thickness > 7,5 mm) / Force de rupture en N (ép. > 7,5 mm) / Bruchlast in N (Dicke > 7,5 mm) / Fuerza de rotura en N (gr. > 7,5 mm) / Разрушающее усилие, Н (толщ. > 7,5 мм)	valore medio 14000 N

AIRTECH	scatola - box			pallet		
	pz	mq	kg	box	mq	kg
60x120 20mm	1	0,72	32,30	30	21,60	990
60x60 20mm	2	0,72	32,10	30	21,60	990



B&W_MARBLE

gres fine porcellanato
fine porcelain stoneware
grès cérame fin
feinsteinzeug-kollektionen
gres porcelánico fino
фарфоровый керамогранит





B&W_MARBLE

L'idea di dualismo cromatico di "B&W" evolve in "**B&W_Marble**", la nuova collezione progettuale del marchio Floor Gres. La serie propone la purezza di tinta dei due opposti di luce per eccellenza, il bianco e il nero, che diventa lo sfondo dal quale prende vita un "pantone lapideo" composto da un ventaglio di elementi dalle forme più o meno regolari che ricordano le venature del marmo. Il marmo viene inteso come una materia fortemente progettuale legata alla terra e alla natura, rafforzando la proposta di osmosi tra ambiente naturale e ambiente costruito tipica del marchio Floor Gres.

The "B&W" idea of chromatic dualism evolves into "**B&W_Marble**", the new Floor Gres collection for architectural projects. The series offers the purity of shades of the most sharply contrasting opposites, white and black, which become the background for a range of "pantone colours in stone", with an assortment of elements of more or less regular shapes that evoke the vein patterns of marble. Marble is viewed here as a material with strong architectural connotations, linked to the earth and nature, reinforcing the concept of osmosis between the natural and built environment typical of the Floor Gres brand.

L'idée de dualisme chromatique de «B&W» évolue en «**B&W_Marble**», la nouvelle collection conceptuelle de la marque Floor Gres. Cette série propose la pureté de teinte des deux opposés par excellence, le blanc et le noir, qui devient le fond donnant vie à un « pantone de pierre » composé d'un éventail d'éléments aux formes plus ou moins régulières qui rappellent les veinures du marbre. Le marbre est perçu comme une matière fortement conceptuelle liée à la terre et à la nature, renforçant ainsi la proposition d'osmose entre environnement naturel et environnement construit typique de la marque Floor Gres.

Aus der Idee des chromatischen Dualismus von „B&W“ entsteht „**B&W_Marble**“, die neue Designkollektion der Marke Floor Gres. Die Serie bietet die Farbreinheit der zwei Lichtgegensätze par excellence, Schwarz und Weiß. Sie bildet den Hintergrund für eine „steingraue Pantone-Farbpalette“, welche sich aus einer Reihe von Elementen mit mehr oder weniger regelmäßigen Formen zusammensetzt, die an Marmoradern erinnern. Unter Marmor ist ein äußerst gestaltbares Material zu verstehen, das mit der Erde und Natur verbunden ist und die Osmoselösung zwischen dem natürlichen Raum und dem vom Menschen erschaffenen Raum verstärkt. Eine Lösung, die für das Markenzeichen Floor Gres so typisch ist.

La idea de dualismo cromático de B&W evoluciona en **B&W_Marble**, la nueva colección de diseño de la marca Floor Gres. La serie propone la pureza cromática de los dos opuestos de luz por excelencia, el blanco y el negro, que deviene el fondo en el que cobra vida un "pantone lapideo" compuesto por un abanico de elementos de formas, más o menos regulares, que recuerdan las vetas del mármol. El mármol es considerado una materia de diseño, fuertemente vinculada a la tierra y a la naturaleza, reforzando la propuesta de ósmosis entre el ambiente natural y el ambiente construido, típica de la marca Floor Gres.

Идея цветового дуализма "B&W" перерождается в "**B&W_Marble**" - новую проектную коллекцию под брендом Floor Gres. Эта серия предлагает чистоту цвета двух противоположностей света по определению - белого и черного, которые становятся фоном, на котором зарождается "палитра камня", состоящая из разнообразия элементов с более или менее регулярными формами, напоминающими прожилки мрамора. Мрамор подразумевается как материал с выраженной проектной направленностью, связанный с землей и природой, усиливая взаимосвязь между природной средой и искусственной, характерную для бренда Floor Gres.

B&W_MARBLE

WHITE



BLACK

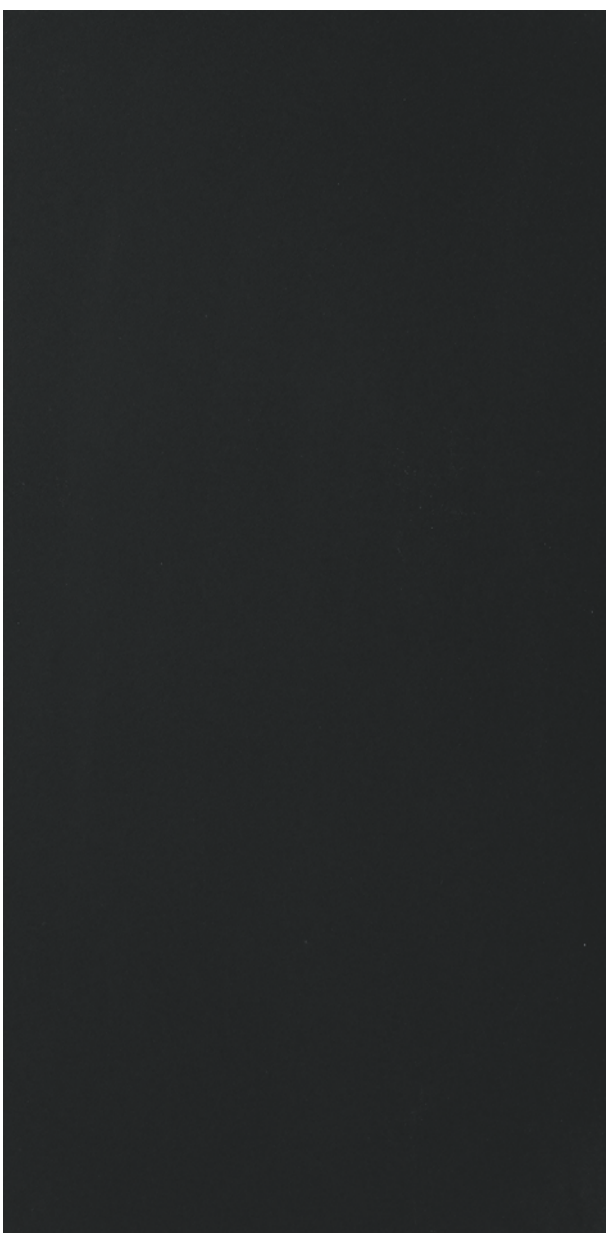

V1

R9

(naturale)

DCOF>
0,42 Wet
(naturale)

10 mm 3/8" ↑↓



V1

R9

(naturale)

DCOF>
0,42 Wet
(naturale)

6 mm 1/4" ↑↓

FLOHM OVERSIZE
magnUm

GRES FINE PORCELLANATO

FINE PORCELAIN STONEWARE / GRÈS CÉRAME FIN / FEINSTEINZEUG-KOLLEKTIONEN / GRES PORCELÁNICO FINO / фарфоровый керамогранит

SQUADRATO - SQUARED - EQUARRI - REKTIFIZIERT - ESCUADRADO - КАЛИБРОВАННА

10 mm 3/8" ↑↓	COLOR	SURFACE	60x120 23 ^{5/8"} x47 ^{1/4"}	80x80 31 ^{1/2"} x31 ^{1/2"}	40x80 15 ^{3/4"} x31 ^{1/2"}	60x60 23 ^{5/8"} x23 ^{5/8"}	30x60 11 ^{4/5"} x23 ^{5/8"}
B&W_MARBLE	WHITE	NATURALE	755567 ■ FL-09100	765313 ■ FL-08100	765317 ■ FL-05800	755473 ■ FL-05800	754462 ■ FL-04900
		HIGH-GLOSSY	755569 ■ FL-10500	765315 ■ FL-09700	765319 ■ FL-07300	755475 ■ FL-07300	754464 ■ FL-06500
	BLACK	NATURALE	755566 ■ FL-09100	765314 ■ FL-08100	765318 ■ FL-05800	755474 ■ FL-05800	754463 ■ FL-04900
		HIGH-GLOSSY	755568 ■ FL-10500	765316 ■ FL-09700	765320 ■ FL-07300	755476 ■ FL-07300	754465 ■ FL-06500
6 mm 1/4" ↑↓	COLOR	SURFACE	160x320 63"x126"	120x280 47 ^{1/4"} x110 ^{1/4"}	120x240 47 ^{1/4"} x94 ^{1/2"}	120x120 47 ^{1/4"} x47 ^{1/4"}	60x120 23 ^{5/8"} x47 ^{1/4"}
B&W_MARBLE	WHITE	NATURALE	751164 ■ FL-14500	765518 ■ FL-10800	751165 ■ FL-09900	751167 ■ FL-08400	751166 ■ FL-07700
		HIGH-GLOSSY	751171 ■ FL-17200	765527 ■ FL-13400	751172 ■ FL-12400	751174 ■ FL-10800	751173 ■ FL-10300
	BLACK	NATURALE	751178 ■ FL-14500	765515 ■ FL-10800	751179 ■ FL-09900	751181 ■ FL-08400	751180 ■ FL-07700
		HIGH-GLOSSY	751185 ■ FL-17200	765525 ■ FL-13400	751186 ■ FL-12400	751188 ■ FL-10800	751187 ■ FL-10300

WAVE

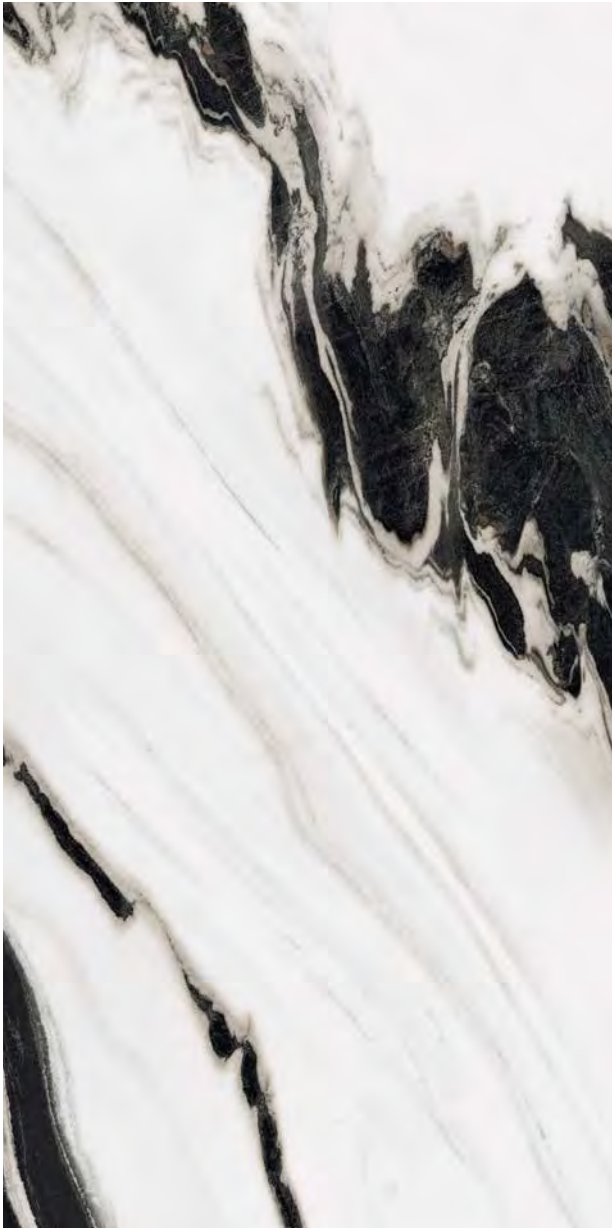

FRAGMENT

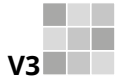

V3

R9
(naturele)

DCOF>
0,42 Wet
(naturele)

10 mm 3/8" ↑↓



V3

R9
(naturele)

DCOF>
0,42 Wet
(naturele)

6 mm 1/4" ↑↓

FLORIM OVERSIZE
magnUm

GRES FINE PORCELLANATO

FINE PORCELAIN STONEWARE / GRÈS CÉRAME FIN / FEINSTEINZEUG-KOLLEKTIONEN / GRES PORCELÁNICO FINO / фарфоровый керамогранит

SQUADRATO - SQUARED - EQUARRI - REKTIFIZIERT - ESCUADRADO - КАЛИБРОВАННА

10 mm 3/8" ↑↓		COLOR	SURFACE	60x120 23 ^{5/8"} x47 ^{1/4"}	80x80 31 ^{1/2"} x31 ^{1/2"}	40x80 15 ^{3/4"} x31 ^{1/2"}	60x60 23 ^{5/8"} x23 ^{5/8"}	30x60 11 ^{4/5"} x23 ^{5/8"}
B&W_MARBLE		WAVE	NATURALE	766391 ■ FL-09100	766377 ■ FL-08100	766394 ■ FL-05800	766483 ■ FL-05800	766481 ■ FL-04900
			HIGH-GLOSSY	766392 ■ FL-10500	766382 ■ FL-09700	766395 ■ FL-07300	766484 ■ FL-07300	766482 ■ FL-06500
		FRAGMENT	NATURALE	766399 ■ FL-09100	766379 ■ FL-08100	766409 ■ FL-05800	766597 ■ FL-05800	766581 ■ FL-04900
			HIGH-GLOSSY	766398 ■ FL-10500	766384 ■ FL-09700	766414 ■ FL-07300	766602 ■ FL-07300	766592 ■ FL-06500
6 mm 1/4" ↑↓		COLOR	SURFACE	160x320 63"x126"	120x280 47 ^{1/4"} x110 ^{1/4"}	120x240 47 ^{1/4"} x94 ^{1/2"}	120x120 47 ^{1/4"} x47 ^{1/4"}	60x120 23 ^{5/8"} x47 ^{1/4"}
B&W_MARBLE		WAVE	NATURALE	765493 ■ FL-14500	765519 ■ FL-10800	765537 ■ FL-09900	765563 ■ FL-08400	765584 ■ FL-07700
			HIGH-GLOSSY	765501 ■ FL-17200	765529 ■ FL-13400	765543 ■ FL-12400	765573 ■ FL-10800	765593 ■ FL-10300
		FRAGMENT	NATURALE	765496 ■ FL-14500	765520 ■ FL-10800	765538 ■ FL-09900	765564 ■ FL-08400	765585 ■ FL-07700
			HIGH-GLOSSY	765502 ■ FL-17200	765531 ■ FL-13400	765544 ■ FL-12400	765574 ■ FL-10800	765595 ■ FL-10300

B&W_MARBLE

BREACH



PEBBLE



R9
(naturale)

DCOF >
0,42 Wet
(naturale)

10 mm 3/8" ↑ ↓



R9
(naturale)

DCOF >
0,42 Wet
(naturale)





6 mm 1/4" ↑ ↓

FLOORM OVERSIZE
magnum

GRES FINE PORCELLANATO

FINE PORCELAIN STONEWARE / GRÈS CÉRAME FIN / FEINSTEINZEUG-KOLLEKTIONEN / GRES PORCELÁNICO FINO / фарфоровый керамогранит

SQUADRATO - SQUARED - EQUARRI - REKTIFIZIERT - ESCUADRADO - КАЛИБРОВАННА

10 mm 3/8" ↑ ↓	COLOR	SURFACE	60x120 23 ^{5/8} "x47 ^{1/4} "	80x80 31 ^{1/2} "x31 ^{1/2} "	40x80 15 ^{3/4} "x31 ^{1/2} "	60x60 23 ^{5/8} "x23 ^{5/8} "	30x60 11 ^{4/5} "x23 ^{5/8} "
B&W_MARBLE		NATURALE	766401 ■ FL-09100	766381 ■ FL-08100	766410 ■ FL-05800	766598 ■ FL-05800	766587 ■ FL-04900
		HIGH-GLOSSY	766402 ■ FL-10500	766387 ■ FL-09700	766415 ■ FL-07300	766603 ■ FL-07300	766593 ■ FL-06500
		NATURALE	766404 ■ FL-09100	766383 ■ FL-08100	766411 ■ FL-05800	766599 ■ FL-05800	766589 ■ FL-04900
		HIGH-GLOSSY	766403 ■ FL-10500	766388 ■ FL-09700	766416 ■ FL-07300	766604 ■ FL-07300	766594 ■ FL-06500
6 mm 1/4" ↑ ↓	COLOR	SURFACE	160x320 63"x126"	120x280 47 ^{1/4} "x110 ^{1/4} "	120x240 47 ^{1/4} "x94 ^{1/2} "	120x120 47 ^{1/4} "x47 ^{1/4} "	60x120 23 ^{5/8} "x47 ^{1/4} "
B&W_MARBLE		NATURALE	765497 ■ FL-14500	765521 ■ FL-10800	765539 ■ FL-09900	765566 ■ FL-08400	765586 ■ FL-07700
		HIGH-GLOSSY	765503 ■ FL-17200	765533 ■ FL-13400	765545 ■ FL-12400	765575 ■ FL-10800	765596 ■ FL-10300
		NATURALE	765498 ■ FL-14500	765522 ■ FL-10800	765540 ■ FL-09900	765568 ■ FL-08400	765587 ■ FL-07700
		HIGH-GLOSSY	765504 ■ FL-17200	765534 ■ FL-13400	765546 ■ FL-12400	765577 ■ FL-10800	765599 ■ FL-10300

FLOW

FALL



V3

R9
(naturale)

DCOF>
0,42 Wet
(naturale)

10 mm 3/8" ↑↓

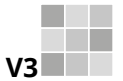

V3

R9
(naturale)

DCOF>
0,42 Wet
(naturale)





6 mm 1/4" ↑↓

FLORM OVERSIZE
magnUm







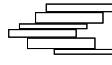

GRES FINE PORCELLANATO

FINE PORCELAIN STONEWARE / GRÈS CÉRAME FIN / FEINSTEINZEUG-KOLLEKTIONEN / GRES PORCELÁNICO FINO / фарфоровый керамогранит

SQUADRATO - SQUARED - EQUARRI - REKTIFIZIERT - ESCUADRADO - КАЛИБРОВАННА

10 mm 3/8" ↑↓		COLOR	SURFACE	60x120 23 ^{5/8"} x47 ^{1/4"}	80x80 31 ^{1/2"} x31 ^{1/2"}	40x80 15 ^{3/4"} x31 ^{1/2"}	60x60 23 ^{5/8"} x23 ^{5/8"}	30x60 11 ^{4/5"} x23 ^{5/8"}
B&W_MARBLE		FLOW	NATURALE	766406 ■ FL-09100	766385 ■ FL-08100	766412 ■ FL-05800	766600 ■ FL-05800	766590 ■ FL-04900
			HIGH-GLOSSY	766405 ■ FL-10500	766389 ■ FL-09700	766417 ■ FL-07300	766605 ■ FL-07300	766595 ■ FL-06500
		FALL	NATURALE	766408 ■ FL-09100	766386 ■ FL-08100	766413 ■ FL-05800	766601 ■ FL-05800	766591 ■ FL-04900
			HIGH-GLOSSY	766407 ■ FL-10500	766390 ■ FL-09700	766418 ■ FL-07300	766606 ■ FL-07300	766596 ■ FL-06500
6 mm 1/4" ↑↓		COLOR	SURFACE	160x320 63"x126"	120x280 47 ^{1/4"} x110 ^{1/4"}	120x240 47 ^{1/4"} x94 ^{1/2"}	120x120 47 ^{1/4"} x47 ^{1/4"}	60x120 23 ^{5/8"} x47 ^{1/4"}
B&W_MARBLE		FLOW	NATURALE	765499 ■ FL-14500	765523 ■ FL-10800	765541 ■ FL-09900	765570 ■ FL-08400	765588 ■ FL-07700
			HIGH-GLOSSY	765505 ■ FL-17200	765535 ■ FL-13400	765547 ■ FL-12400	765578 ■ FL-10800	765600 ■ FL-10300
		FALL	NATURALE	765500 ■ FL-14500	765524 ■ FL-10800	765542 ■ FL-09900	765571 ■ FL-08400	765589 ■ FL-07700
			HIGH-GLOSSY	765506 ■ FL-17200	765536 ■ FL-13400	765548 ■ FL-12400	765579 ■ FL-10800	765602 ■ FL-10300

B&W_MARBLE

10 mm 3/8" ↑				30x30 1 1/4"x1 1/4"  mosaico tessere 3x3 pz/box 11	21x40 8 1/4"x15 3/4"  listello sfalsato
B&W_MARBLE		WHITE	NATURALE	767385 ▲ FL-02000	767401 ■ FL-17200
			HIGH-GLOSSY	767376 ▲ FL-02300	767393 ■ FL-21000
		BLACK	NATURALE	767386 ▲ FL-02000	767402 ■ FL-17200
			HIGH-GLOSSY	767377 ▲ FL-02300	767394 ■ FL-21000
		WAVE	NATURALE	767387 ▲ FL-02000	767403 ■ FL-17200
			HIGH-GLOSSY	767378 ▲ FL-02300	767395 ■ FL-21000
		FRAGMENT	NATURALE	767388 ▲ FL-02000	767404 ■ FL-17200
			HIGH-GLOSSY	767379 ▲ FL-02300	767396 ■ FL-21000
		BREACH	NATURALE	767389 ▲ FL-02000	767405 ■ FL-17200
			HIGH-GLOSSY	767380 ▲ FL-02300	767397 ■ FL-21000
		PEBBLE	NATURALE	767390 ▲ FL-02000	767406 ■ FL-17200
			HIGH-GLOSSY	767381 ▲ FL-02300	767398 ■ FL-21000
		FLOW	NATURALE	767391 ▲ FL-02000	767407 ■ FL-17200
			HIGH-GLOSSY	767383 ▲ FL-02300	767399 ■ FL-21000
	FALL	NATURALE	767392 ▲ FL-02000	767408 ■ FL-17200	
		HIGH-GLOSSY	767384 ▲ FL-02300	767400 ■ FL-21000	



Per un effetto ottimale della posa, florim suggerisce di mantenere 2 mm di fuga per pose monofornate e 3 mm per combinare formati misti - For optimal installation results, florim recommends maintaining a joint of 2 mm 1/12" for single format installations and 3 mm 1/8" to combine mixed formats. - Pour réaliser une pose parfaite, florim suggère de maintenir 2 mm de joint pour la pose des monofornats, et 3 mm pour les combinaisons de formats mixtes. - Um einen optimalen effekt beim verlegen zu erzielen empfiehlt florim eine 2 mm fugen bei einformatigen verlegungen und 3 mm fugen bei formatkombinationen Para lograr los máximos resultados en la posa del producto, florim aconseja 2 mm de junta en aplicaciones monofornate y 3 mm en combinaciones de formatos mixtos - **ДЛЯ ОПТИМАЛЬНОЙ УКЛАДКИ " FLORIM" РЕКОМЕНДУЕТ ВЫДЕРЖИВАТЬ ЗАЗОР 2 ММ ДЛЯ МОНОФОРМАТА И 3 ММ ПРИ СМЕШАННЫХ ФОРМАТАХ.**

In relazione alle differenti tecnologie produttive l'accostamento di prodotti con spessori diversi potrebbe presentare delle disomogeneità, se ne sconsiglia pertanto l'abbinamento. / Due to the different production technologies, contiguous installation of products with different thickness may give a non-homogeneous result. For this reason we do not recommend this option. / Vu que différentes technologies de production sont utilisées avec des épaisseurs différentes, des problèmes d'homogénéité pourraient se présenter, il est donc déconseillé de les poser ensemble. / Wegen unterschiedlicher Produktionstechnologien können die Fliesen mit verschiedenen Materialstärken optische Differenzen aufweisen. Von einem direkten Aneinanderlegen wird deshalb abgeraten. / Dadas las diferentes tecnologías productivas, la combinación de productos de diferentes espesores podría dar lugar a heterogeneidad, por lo que se desaconseja mezclarlas. / В связи с различием в технологиях производства, сочетание продукции разной толщины иногда может представлять неоднородность материала. Такие сочетания следует избегать.

Architectural design

PEZZI SPECIALI/SPECIAL TRIMS/PIÈCES SPÉCIALES/FORMSTÜCKE/PIEZAS ESPECIALES/Специальные изделия

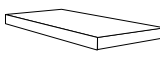
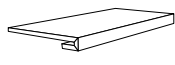
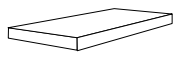
10 mm 3/8" ↑↓

	COLOR	SURFACE	4,6x60 1 4/8"x23 3/8" 	33x120x3 13"x47 1/4"x1 1/8" 	33x120x3 13"x47 1/4"x1 1/8" 	33x120x3 13"x47 1/4"x1 1/8" 	
			battiscopa	angolo gradino DX pz/box 2	gradino pz/box 2	angolo gradino SX pz/box 2	
B&W_MARBLE		WHITE	NATURALE	756613 ◆ FL-01600	767430 ▲ FL-31100	767422 ▲ FL-20400	767438 ▲ FL-31100
		HIGH-GLOSSY	756611 ◆ FL-01600	-	-	-	
		BLACK	NATURALE	756614 ◆ FL-01600	767431 ▲ FL-31100	767423 ▲ FL-20400	767439 ▲ FL-31100
		HIGH-GLOSSY	756612 ◆ FL-01600	-	-	-	
		WAVE	NATURALE	767415 ◆ FL-01600	767432 ▲ FL-31100	767424 ▲ FL-20400	767440 ▲ FL-31100
		HIGH-GLOSSY	767409 ◆ FL-01600	-	-	-	
		FRAGMENT	NATURALE	767416 ◆ FL-01600	767433 ▲ FL-31100	767425 ▲ FL-20400	767441 ▲ FL-31100
		HIGH-GLOSSY	767410 ◆ FL-01600	-	-	-	
		BREACH	NATURALE	767417 ◆ FL-01600	767434 ▲ FL-31100	767426 ▲ FL-20400	767442 ▲ FL-31100
		HIGH-GLOSSY	767411 ◆ FL-01600	-	-	-	
		PEBBLE	NATURALE	767418 ◆ FL-01600	767435 ▲ FL-31100	767427 ▲ FL-20400	767443 ▲ FL-31100
		HIGH-GLOSSY	767412 ◆ FL-01600	-	-	-	
		FLOW	NATURALE	767420 ◆ FL-01600	767436 ▲ FL-31100	767428 ▲ FL-20400	767444 ▲ FL-31100
		HIGH-GLOSSY	767413 ◆ FL-01600	-	-	-	
		FALL	NATURALE	767421 ◆ FL-01600	767437 ▲ FL-31100	767429 ▲ FL-20400	767445 ▲ FL-31100
		HIGH-GLOSSY	767414 ◆ FL-01600	-	-	-	

FLORIM OVERSIZE
magnUm

160x320/120x280/120x240/120x120/60x120

Specifica Imballo pag.
Packaging specifications on page
Spécifications d'emballage à page
Verpackungsdetail Seite
Especificaciones de embalaje a la página
Информация об упаковке на стр.













176/177

B&W_MARBLE	scatola - box			pallet		
	pz	mq	kg	box	mq	kg
60x120	2	1,44	33,40	30	43,20	1030
80x80	2	1,28	29,80	40	51,20	1220
40x80	3	0,96	22,00	56	53,76	1260
60x60	3	1,08	24,10	40	43,20	990
30x60	6	1,08	24,10	40	43,20	990
21x40 modulo listello sfalsato	5	0,42	9,70	40	16,80	410

B&W_MARBLE	scatola - box			pallet		
	pz	ml	kg	box	mq	kg
4,6x60 battiscopa	14	8,40	8,40	-	-	-

B&W_MARBLE

PEZZI SPECIALI/SPECIAL TRIMS/PIÈCES SPÉCIALES/FORMSTÜCKE/PIEZAS ESPECIALES/Специальные изделия

6 mm 1/4" ↑↓		COLOR	SURFACE	30x30 11 4/5" x 11 4/5"  mosaico tessere 7,5x7,5 pz/box 11	30x30 11 4/5" x 11 4/5"  muretto tessere 7,5x15 pz/box 11	30x30 11 4/5" x 11 4/5"  mosaico tessere 1,5x3 pz/box 11	4,6x80 1 4/5" x 3 1/2"  battiscopa
B&W_MARBLE		WHITE	NATURALE	751192 ▲ FL-01800	751196 ▲ FL-01800	751200 ▲ FL-02700	751204 ◆ FL-01800
		HIGH-GLOSSY	751194 ▲ FL-02100	751198 ▲ FL-02100	751202 ▲ FL-03100	751206 ◆ FL-01800	
		BLACK	NATURALE	751193 ▲ FL-01800	751197 ▲ FL-01800	751201 ▲ FL-02700	751205 ◆ FL-01800
		HIGH-GLOSSY	751195 ▲ FL-02100	751199 ▲ FL-02100	751203 ▲ FL-03100	751207 ◆ FL-01800	
		WAVE	NATURALE	767452 ▲ FL-01800	767464 ▲ FL-01800	767476 ▲ FL-02700	767488 ◆ FL-01800
		HIGH-GLOSSY	767446 ▲ FL-02100	767458 ▲ FL-02100	767470 ▲ FL-03100	767482 ◆ FL-01800	
		FRAGMENT	NATURALE	767453 ▲ FL-01800	767465 ▲ FL-01800	767477 ▲ FL-02700	767489 ◆ FL-01800
		HIGH-GLOSSY	767447 ▲ FL-02100	767459 ▲ FL-02100	767471 ▲ FL-03100	767483 ◆ FL-01800	
		BREACH	NATURALE	767454 ▲ FL-01800	767466 ▲ FL-01800	767478 ▲ FL-02700	767490 ◆ FL-01800
		HIGH-GLOSSY	767448 ▲ FL-02100	767460 ▲ FL-02100	767472 ▲ FL-03100	767484 ◆ FL-01800	
		PEBBLE	NATURALE	767455 ▲ FL-01800	767467 ▲ FL-01800	767479 ▲ FL-02700	767491 ◆ FL-01800
		HIGH-GLOSSY	767449 ▲ FL-02100	767461 ▲ FL-02100	767473 ▲ FL-03100	767485 ◆ FL-01800	
		FLOW	NATURALE	767456 ▲ FL-01800	767468 ▲ FL-01800	767480 ▲ FL-02700	767492 ◆ FL-01800
		HIGH-GLOSSY	767450 ▲ FL-02100	767462 ▲ FL-02100	767474 ▲ FL-03100	767486 ◆ FL-01800	
		FALL	NATURALE	767457 ▲ FL-01800	767469 ▲ FL-01800	767481 ▲ FL-02700	767493 ◆ FL-01800
		HIGH-GLOSSY	767451 ▲ FL-02100	767463 ▲ FL-02100	767475 ▲ FL-03100	767487 ◆ FL-01800	

6 mm 1/4" ↑↓

COLOR

SURFACE

60x120
23^{5/8}"x47^{1/4}"

B&W_MARBLE



B&W DECOR

NATURALE

767918
■ FL-29000





BUILDTECH/2.0

gres fine porcellanato
fine porcelain stoneware
grès cérame fin
feinsteinzeug-kollektionen
gres porcelánico fino
фарфоровый керамогранит





BUILDTECH/2.0

In **Buildtech/2.0** il tema del cemento si accompagna a quello del colore. Coerenza e costanza nella ricerca hanno permesso di sviluppare un approccio intuitivo fatto di interesse e curiosità verso i possibili modi di vivere. Interprete di uno stile essenziale ma sofisticato che si evidenzia nella possibilità di molteplici combinazioni tra effetti e differenti superfici studiate per integrarsi ed essere protagoniste dei progetti più accattivanti.

The theme of cement goes hand in hand with that of colour in **Buildtech/ 2.0**. Consistency and constancy in research are the hallmarks of our intuitive approach made up of interest and curiosity regarding possible ways of living. An exponent of an essential yet sophisticated style featuring a wide array of possible combinations of effects and different surfaces designed to complement and star in eye-catching projects.

Dans **Buildtech/ 2.0** le thème du ciment s'accompagne de celui de la couleur. Une recherche cohérente et constante a permis de développer une approche intuitive faite d'intérêt et de curiosité pour les différents modes de vie possibles. Interprete d'un style à la fois essentiel et sophistiqué révélé par les multiples combinaisons d'effets et les différentes surfaces étudiées pour s'intégrer et être protagonistes des projets les plus séduisants.

In **Buildtech/ 2.0** geht das Thema Zement mit der Farbe einher. Dank einer kohärenten und konstanten Forschungstätigkeit wurde ein intuitiver Ansatz entwickelt, der auf dem Interesse und der Neugierde für mögliche Lebensweisen basiert. Der Interpret eines aufs Wesentliche beschränkte, nichtsdestotrotz jedoch edlen Stils, der durch vielfache Kombinationsmöglichkeiten von Effekten und verschiedenen Oberflächen hervorgehoben wird, welche sich integrieren und die Protagonisten der attraktivsten Projekte sind.

En **Buildtech/ 2.0** el tema del cemento se acompaña con el del color. Coherencia y constancia en la búsqueda han permitido desarrollar un enfoque intuitivo basado en el interés y en la curiosidad por las posibles formas de vivir. Una colección intérprete de un estilo esencial, aunque sofisticado, que se manifiesta en la posibilidad de múltiples combinaciones entre efectos y distintas superficies estudiadas para integrarse y ser protagonistas de los proyectos más atractivos.

В **Buildtech/ 2.0** теме цемента сопутствует тема цвета. Поступательность и постоянство в исследовательской работе позволили компании разработать интуитивный подход, характеризующийся интересом и любопытством к разным возможным стилям жизни. Серия создана в сдержанном, но изысканном стиле, предлагающем многочисленные сочетания эффектов и разных поверхностей, разработанных для интеграции в реализации очень привлекательных проектов.

BUILDTECH/2.0

BUILD_WHITE TU

BUILD_WHITE GG



R10
CLASSE B
(naturale
TU/GG)

R11
CLASSE C
(strutturato)

DCOF >
0,42 Wet
(naturale/
strutturato)

10 mm 3/8" ↓↑

GRES FINE PORCELLANATO

FINE PORCELAIN STONEWARE / GRÈS CÉRAME FIN / FEINSTEINZEUG-KOLLEKTIONEN / GRES PORCELÁNICO FINO / фарфоровый керамогранит

SQUADRATO - SQUARED - EQUARRI - REKTIFIZIERT - ESCUADRADO - КАЛИБРОВАННА

10 mm 3/8" ↓↑	COLOR	SURFACE	60x120 23 ^{5/8"} x47 ^{1/4"}	80x80 31 ^{1/2"} x31 ^{1/2"}	40x80 15 ^{3/4"} x31 ^{1/2"}	60x60 23 ^{5/8"} x23 ^{5/8"}	30x60 11 ^{4/8"} x23 ^{5/8"}
BUILDTECH/2.0	BUILD_WHITE TU	LEVIGATO	748995 ■ FL-10500	-	-	749031 ■ FL-07300	749085 ■ FL-06500
		NATURALE	748989 ■ FL-09100	748881 ■ FL-08100	748935 ■ FL-05800	749025 ■ FL-05800	749079 ■ FL-04900
		STRUTTURATO	-	748893 ■ FL-08100	748947 ■ FL-05800	749037 ■ FL-05800	749091 ■ FL-04900
	BUILD_WHITE GG	LEVIGATO	749019 ■ FL-10500	-	-	749067 ■ FL-07300	749121 ■ FL-06500
		NATURALE	749013 ■ FL-09100	748917 ■ FL-08100	748971 ■ FL-05800	749061 ■ FL-05800	749115 ■ FL-04900
		STRUTTURATO	-	748929 ■ FL-08100	748983 ■ FL-05800	749073 ■ FL-05800	749127 ■ FL-04900

BUILD_WHITE CE

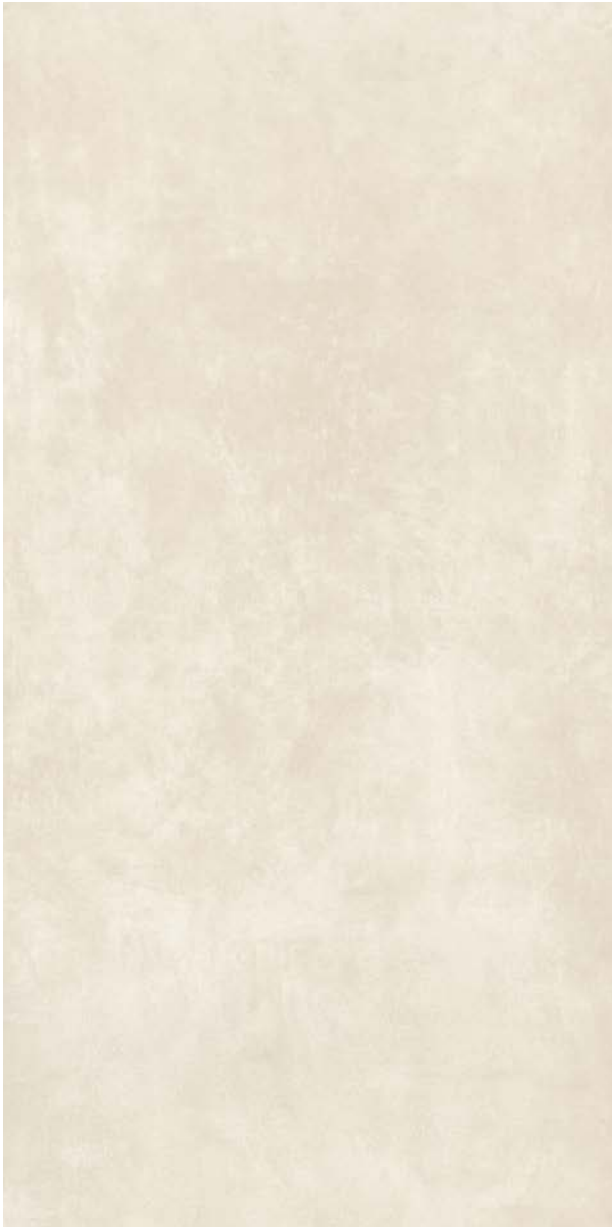

CE

**R10
CLASSE A**
(naturale CE)

R9
(soft CE)

**R10
CLASSE B**
(R+PTV)

**R11
CLASSE C**
(strutturato)

DCOF>
0,42 Wet
(naturale/soft
strutturato)

PTV
>36 wet
slider 4S
(R+PTV)

10 mm 3/8" ↑↓

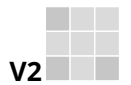

**R9
CLASSE A**
(naturale)

**R10
CLASSE B**
(R+PTV)

DCOF>
0,42 Wet

PTV
>36 wet
slider 4S
(R+PTV)

6 mm 1/4" ↑↓

FLORIM OVERSIZE
magnUm

GRES FINE PORCELLANATO

FINE PORCELAIN STONEWARE / GRÈS CÉRAME FIN / FEINSTEINZEUG-KOLLEKTIONEN / GRES PORCELÁNICO FINO / фарфоровый керамогранит

SQUADRATO - SQUARED - EQUARRI - REKTIFIZIERT - ESCUADRADO - КАЛИБРОВАННА

10 mm 3/8" ↑↓	COLOR	SURFACE	60x120 23 ^{5/8"} x47 ^{1/4"}	80x80 31 ^{1/2"} x31 ^{1/2"}	40x80 15 ^{3/4"} x31 ^{1/2"}	60x60 23 ^{5/8"} x23 ^{5/8"}	30x60 11 ^{4/8"} x23 ^{5/8"}
BUILDTECH/2.0	BUILD_WHITE CE	NATURALE	765232 ■ FL-09100	765244 ■ FL-08100	765252 ■ FL-05800	765264 ■ FL-05800	765280 ■ FL-04900
		SOFT	765236 ■ FL-09100	765248 ■ FL-08100	765256 ■ FL-05800	765268 ■ FL-05800	765284 ■ FL-04900
		R+PTV	765240 ■ FL-09100	-	-	765276 ■ FL-05800	765292 ■ FL-04900
		STRUTTURATO	-	-	765260 ■ FL-05800	765272 ■ FL-05800	765288 ■ FL-04900

6 mm 1/4" ↑↓	COLOR	SURFACE	120x240 47 ^{1/4"} x94 ^{1/2"}	120x120 47 ^{1/4"} x47 ^{1/4"}	60x120 23 ^{5/8"} x47 ^{1/4"}
BUILDTECH/2.0	BUILD_WHITE CE	NATURALE	766105 ■ FL-09900	766116 ■ FL-08400	766131 ■ FL-07700
		R+PTV	766110 ■ FL-09900	766121 ■ FL-08400	-

BUILD_BONE TU

BUILD_BONE GG



R10
CLASSE B
(naturale
TU/GG)

R11
CLASSE C
(strutturato)

DCOF>
0,42 Wet
(naturale/
strutturato)

10 mm 3/8" ↑↓

GRES FINE PORCELLANATO

FINE PORCELAIN STONEWARE / GRÈS CÉRAME FIN / FEINSTEINZEUG-KOLLEKTIONEN / GRES PORCELÁNICO FINO / фарфоровый керамогранит

SQUADRATO - SQUARED - EQUARRI - REKTIFIZIERT - ESCUADRADO - КАЛИБРОВАННА

10 mm 3/8" ↑↓	COLOR	SURFACE	60x120 23 ^{5/8"} x47 ^{1/4"}	80x80 31 ^{1/2"} x31 ^{1/2"}	40x80 15 ^{3/4"} x31 ^{1/2"}	60x60 23 ^{5/8"} x23 ^{5/8"}	30x60 11 ^{4/8"} x23 ^{5/8"}
BUILDTECH/2.0	BUILD_BONE TU	LEVIGATO	748996 ■ FL-10500	-	-	749032 ■ FL-07300	749086 ■ FL-06500
		NATURALE	748990 ■ FL-09100	748882 ■ FL-08100	748936 ■ FL-05800	749026 ■ FL-05800	749080 ■ FL-04900
		STRUTTURATO	-	748894 ■ FL-08100	748948 ■ FL-05800	749038 ■ FL-05800	749092 ■ FL-04900
	BUILD_BONE GG	LEVIGATO	749020 ■ FL-10500	-	-	749068 ■ FL-07300	749122 ■ FL-06500
		NATURALE	749014 ■ FL-09100	748918 ■ FL-08100	748972 ■ FL-05800	749062 ■ FL-05800	749116 ■ FL-04900
		STRUTTURATO	-	748930 ■ FL-08100	748984 ■ FL-05800	749074 ■ FL-05800	749128 ■ FL-04900

BUILD_BONE CE



CE

**R10
CLASSE A**
(naturale CE)

R9
(soft CE)

**R10
CLASSE B**
(R+PTV)

**R11
CLASSE C**
(strutturato)

DCOF>
0,42 Wet
(naturale/soft
strutturato)

PTV
>36 wet
slider 4S
(R+PTV)

10 mm 3/8" ↑↓

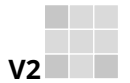

CE

**R9
CLASSE A**
(naturale)

**R10
CLASSE B**
(R+PTV)

DCOF>
0,42 Wet

PTV
>36 wet
slider 4S
(R+PTV)

6 mm 1/4" ↑↓

FLOORM OVERSIZE
magnum

GRES FINE PORCELLANATO

FINE PORCELAIN STONEWARE / GRÈS CÉRAMÉ FIN / FEINSTEINZEUG-KOLLEKTIONEN / GRES PORCELÁNICO FINO / фарфоровый керамогранит
SQUADRATO - SQUARED - EQUARRI - REKTIFIZIERT - ESCUADRADO - КАЛИБРОВАННА

10 mm 3/8" ↑↓	COLOR	SURFACE	60x120 23 ^{5/8"} x47 ^{1/4"}	80x80 31 ^{1/2"} x31 ^{1/2"}	40x80 15 ^{3/4"} x31 ^{1/2"}	60x60 23 ^{5/8"} x23 ^{5/8"}	30x60 11 ^{4/8"} x23 ^{5/8"}
BUILDTECH/2.0	BUILD_BONE CE	NATURALE	765233 ■ FL-09100	765245 ■ FL-08100	765253 ■ FL-05800	765265 ■ FL-05800	765281 ■ FL-04900
		SOFT	765237 ■ FL-09100	765249 ■ FL-08100	765257 ■ FL-05800	765269 ■ FL-05800	765285 ■ FL-04900
		R+PTV	765241 ■ FL-09100	-	-	765277 ■ FL-05800	765293 ■ FL-04900
		STRUTTURATO	-	-	765261 ■ FL-05800	765273 ■ FL-05800	765289 ■ FL-04900
6 mm 1/4" ↑↓	COLOR	SURFACE	120x240 47 ^{1/4"} x94 ^{1/2"}	120x120 47 ^{1/4"} x47 ^{1/4"}	60x120 23 ^{5/8"} x47 ^{1/4"}		
BUILDTECH/2.0	BUILD_BONE CE	NATURALE	766107 ■ FL-09900	766118 ■ FL-08400	766133 ■ FL-07700		
		R+PTV	766112 ■ FL-09900	766123 ■ FL-08400	-		

BUILDTECH/2.0

BUILD_MUD TU



BUILD_MUD GG



R10
CLASSE B
(naturale
TU/GG)

R11
CLASSE C
(strutturato)

DCOF>
0,42 Wet
(naturale/
strutturato)

10 mm 3/8" ↑↓

GRES FINE PORCELLANATO

FINE PORCELAIN STONEWARE / GRÈS CÉRAME FIN / FEINSTEINZEUG-KOLLEKTIONEN / GRES PORCELÁNICO FINO / фарфоровый керамогранит

SQUADRATO - SQUARED - EQUARRI - REKTIFIZIERT - ESCUADRADO - КАЛИБРОВАННА

10 mm 3/8" ↑↓	COLOR	SURFACE	60x120 23 ^{5/8"} x47 ^{1/4"}	80x80 31 ^{1/2"} x31 ^{1/2"}	40x80 15 ^{3/4"} x31 ^{1/2"}	60x60 23 ^{5/8"} x23 ^{5/8"}	30x60 11 ^{4/8"} x23 ^{5/8"}
BUILDTECH/2.0	BUILD_MUD TU	LEVIGATO	748999 ■ FL-10500	-	-	749035 ■ FL-07300	749089 ■ FL-06500
		NATURALE	748993 ■ FL-09100	748885 ■ FL-08100	748939 ■ FL-05800	749029 ■ FL-05800	749083 ■ FL-04900
		STRUTTURATO	-	748897 ■ FL-08100	748951 ■ FL-05800	749041 ■ FL-05800	749095 ■ FL-04900
	BUILD_MUD GG	LEVIGATO	749023 ■ FL-10500	-	-	749071 ■ FL-07300	749125 ■ FL-06500
		NATURALE	749017 ■ FL-09100	748921 ■ FL-08100	748975 ■ FL-05800	749065 ■ FL-05800	749119 ■ FL-04900
		STRUTTURATO	-	748933 ■ FL-08100	748987 ■ FL-05800	749077 ■ FL-05800	749131 ■ FL-04900

BUILD_MUD CE



CE

**R10
CLASSE A**
(naturale CE)

R9
(soft CE)

**R10
CLASSE B**
(R+PTV)

**R11
CLASSE C**
(strutturato)

DCOF>
0,42 Wet
(naturale/soft
strutturato)

PTV
>36 wet
slider 4S
(R+PTV)

10 mm 3/8" ↑↓

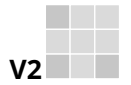

**R9
CLASSE A**
(naturale)

**R10
CLASSE B**
(R+PTV)

DCOF>
0,42 Wet

PTV
>36 wet
slider 4S
(R+PTV)

6 mm 1/4" ↑↓

FLORIM OVERSIZE
magnUm

GRES FINE PORCELLANATO

FINE PORCELAIN STONEWARE / GRÈS CÉRAME FIN / FEINSTEINZEUG-KOLLEKTIONEN / GRES PORCELÁNICO FINO / фарфоровый керамогранит
SQUADRATO - SQUARED - EQUARRI - REKTIFIZIERT - ESCUADRADO - КАЛИБРОВАННА

10 mm 3/8" ↑↓	COLOR	SURFACE	60x120 23 ^{5/8"} x47 ^{1/4"}	80x80 31 ^{1/2"} x31 ^{1/2"}	40x80 15 ^{3/4"} x31 ^{1/2"}	60x60 23 ^{5/8"} x23 ^{5/8"}	30x60 11 ^{4/8"} x23 ^{5/8"}
BUILDTECH/2.0	BUILD_MUD CE	NATURALE	765234 ■ FL-09100	765246 ■ FL-08100	765254 ■ FL-05800	765266 ■ FL-05800	765282 ■ FL-04900
		SOFT	765238 ■ FL-09100	765250 ■ FL-08100	765258 ■ FL-05800	765270 ■ FL-05800	765286 ■ FL-04900
		R+PTV	765242 ■ FL-09100	-	-	765278 ■ FL-05800	765294 ■ FL-04900
		STRUTTURATO	-	-	765262 ■ FL-05800	765274 ■ FL-05800	765290 ■ FL-04900
6 mm 1/4" ↑↓	COLOR	SURFACE	120x240 47 ^{1/4"} x94 ^{1/2"}	120x120 47 ^{1/4"} x47 ^{1/4"}	60x120 23 ^{5/8"} x47 ^{1/4"}		
BUILDTECH/2.0	BUILD_MUD CE	NATURALE	766108 ■ FL-09900	766119 ■ FL-08400	766134 ■ FL-07700		
		R+PTV	766113 ■ FL-09900	766124 ■ FL-08400	-		

BUILDTECH/2.0

BUILD_COAL TU

BUILD_COAL GG

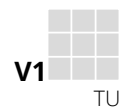

R10
CLASSE B
(naturale
TU/GG)

R11
CLASSE C
(strutturato)

DCOF >
0,42 Wet
(naturale/
strutturato)

10 mm 3/8" ↑↓

GRES FINE PORCELLANATO

FINE PORCELAIN STONEWARE / GRÈS CÉRAME FIN / FEINSTEINZEUG-KOLLEKTIONEN / GRES PORCELÁNICO FINO / фарфоровый керамогранит

SQUADRATO - SQUARED - EQUARRI - REKTIFIZIERT - ESCUADRADO - КАЛИБРОВАННА

10 mm 3/8" ↑↓	COLOR	SURFACE	60x120 23 ^{5/8"} x47 ^{11/4"}	80x80 31 ^{1/2"} x31 ^{1/2"}	40x80 15 ^{3/4"} x31 ^{1/2"}	60x60 23 ^{5/8"} x23 ^{5/8"}	30x60 11 ^{4/8"} x23 ^{5/8"}
BUILDTECH/2.0	BUILD_COAL TU	LEVIGATO	749000 ■ FL-10500	-	-	749036 ■ FL-07300	749090 ■ FL-06500
		NATURALE	748994 ■ FL-09100	748886 ■ FL-08100	748940 ■ FL-05800	749030 ■ FL-05800	749084 ■ FL-04900
		STRUTTURATO	-	748898 ■ FL-08100	748952 ■ FL-05800	749042 ■ FL-05800	749096 ■ FL-04900
	BUILD_COAL GG	LEVIGATO	749024 ■ FL-10500	-	-	749072 ■ FL-07300	749126 ■ FL-06500
		NATURALE	749018 ■ FL-09100	748922 ■ FL-08100	748976 ■ FL-05800	749066 ■ FL-05800	749120 ■ FL-04900
		STRUTTURATO	-	748934 ■ FL-08100	748988 ■ FL-05800	749078 ■ FL-05800	749132 ■ FL-04900

BUILD_COAL CE



CE

**R10
CLASSE A**
(naturale CE)

R9
(soft CE)

**R10
CLASSE B**
(R+PTV)

**R11
CLASSE C**
(strutturato)

DCOF>
0,42 Wet
(naturale/soft
strutturato)

PTV
>36 wet
slider 4S
(R+PTV)

10 mm 3/8" ↑↓

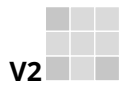

**R9
CLASSE A**
(naturale)

**R10
CLASSE B**
(R+PTV)

DCOF>
0,42 Wet

PTV
>36 wet
slider 4S
(R+PTV)

6 mm 1/4" ↑↓

FLORIM OVERSIZE
magnum











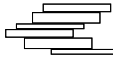



GRES FINE PORCELLANATO

FINE PORCELAIN STONEWARE / GRÈS CÉRAME FIN / FEINSTEINZEUG-KOLLEKTIONEN / GRES PORCELÁNICO FINO / фарфоровый керамогранит
SQUADRATO - SQUARED - EQUARRI - REKTIFIZIERT - ESCUADRADO - КАЛИБРОВАННА

10 mm 3/8" ↑↓	COLOR	SURFACE	60x120 23 ^{5/8"} x47 ^{1/4"}	80x80 31 ^{1/2"} x31 ^{1/2"}	40x80 15 ^{3/4"} x31 ^{1/2"}	60x60 23 ^{5/8"} x23 ^{5/8"}	30x60 11 ^{4/8"} x23 ^{5/8"}
BUILDTECH/2.0	BUILD_COAL CE	NATURALE	765235 ■ FL-09100	765247 ■ FL-08100	765255 ■ FL-05800	765267 ■ FL-05800	765283 ■ FL-04900
		SOFT	765239 ■ FL-09100	765251 ■ FL-08100	765259 ■ FL-05800	765271 ■ FL-05800	765287 ■ FL-04900
		R+PTV	765243 ■ FL-09100	-	-	765279 ■ FL-05800	765295 ■ FL-04900
		STRUTTURATO	-	-	765263 ■ FL-05800	765275 ■ FL-05800	765291 ■ FL-04900
6 mm 1/4" ↑↓	COLOR	SURFACE	120x240 47 ^{1/4"} x94 ^{1/2"}	120x120 47 ^{1/4"} x47 ^{1/4"}	60x120 23 ^{5/8"} x47 ^{1/4"}		
BUILDTECH/2.0	BUILD_COAL CE	NATURALE	766109 ■ FL-09900	766120 ■ FL-08400	766135 ■ FL-07700		
		R+PTV	766114 ■ FL-09900	766125 ■ FL-08400	-		

BUILDTECH/2.0

10 mm 3/8" ↑ ↓

	COLOR	SURFACE	30x30 11 4/5"x11 4/5"  mosaico tessere 3x3 pz/box 11	21x40 8 1/4"x15 3/4"  listello sfalsato pz/box 5	30x30 11 4/5"x11 4/5"  mattoncino tessere 7,5x15 pz/box 11
	BUILD_WHITE TU	LEVIGATO	749229 ▲ FL-02300	749193 ▲ FL-01700	749265 ▲ FL-01700
		NATURALE	749223 ▲ FL-02000	749187 ▲ FL-01600	749259 ▲ FL-01500
	BUILD_WHITE GG	LEVIGATO	749253 ▲ FL-02300	749217 ▲ FL-01700	749289 ▲ FL-01700
		NATURALE	749247 ▲ FL-02000	749211 ▲ FL-01600	749283 ▲ FL-01500
	BUILD_WHITE CE	NATURALE	767494 ▲ FL-02000	767502 ▲ FL-01600	767511 ▲ FL-01500
		SOFT	767498 ▲ FL-02000	767506 ▲ FL-01600	767515 ▲ FL-01500
	BUILD_BONE TU	LEVIGATO	749230 ▲ FL-02300	749194 ▲ FL-01700	749266 ▲ FL-01700
		NATURALE	749224 ▲ FL-02000	749188 ▲ FL-01600	749260 ▲ FL-01500
	BUILD_BONE GG	LEVIGATO	749254 ▲ FL-02300	749218 ▲ FL-01700	749290 ▲ FL-01700
		NATURALE	749248 ▲ FL-02000	749212 ▲ FL-01600	749284 ▲ FL-01500
	BUILD_BONE CE	NATURALE	767495 ▲ FL-02000	767503 ▲ FL-01600	767512 ▲ FL-01500
		SOFT	767499 ▲ FL-02000	767508 ▲ FL-01600	767516 ▲ FL-01500
	BUILD_MUD TU	LEVIGATO	749233 ▲ FL-02300	749197 ▲ FL-01700	749269 ▲ FL-01700
		NATURALE	749227 ▲ FL-02000	749191 ▲ FL-01600	749263 ▲ FL-01500
	BUILD_MUD GG	LEVIGATO	749257 ▲ FL-02300	749221 ▲ FL-01700	749293 ▲ FL-01700
		NATURALE	749251 ▲ FL-02000	749215 ▲ FL-01600	749287 ▲ FL-01500
	BUILD_MUD CE	NATURALE	767496 ▲ FL-02000	767504 ▲ FL-01600	767513 ▲ FL-01500
		SOFT	767500 ▲ FL-02000	767509 ▲ FL-01600	767517 ▲ FL-01500
	BUILD_COAL TU	LEVIGATO	749234 ▲ FL-02300	749198 ▲ FL-01700	749270 ▲ FL-01700
		NATURALE	749228 ▲ FL-02000	749192 ▲ FL-01600	749264 ▲ FL-01500
	BUILD_COAL GG	LEVIGATO	749258 ▲ FL-02300	749222 ▲ FL-01700	749294 ▲ FL-01700
		NATURALE	749252 ▲ FL-02000	749216 ▲ FL-01600	749288 ▲ FL-01500
	BUILD_COAL CE	NATURALE	749497 ▲ FL-02000	767505 ▲ FL-01600	767514 ▲ FL-01500
		SOFT	767501 ▲ FL-02000	767510 ▲ FL-01600	767518 ▲ FL-01500













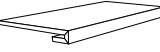
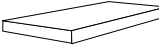

BUILDTECH/2.0

Per un effetto ottimale della posa, florim suggerisce di mantenere 2 mm di fuga per pose monoformato e 3 mm per combinare formati misti. - For optimal installation results, florim recommends maintaining a joint of 2 mm 1/12" for single format installations and 3 mm 1/8" to combine mixed formats. - Pour réaliser une pose parfaite, florim suggère de maintenir 2 mm de joint pour la pose des monoformats, et 3 mm pour les combinaisons de formats mixtes. - Um einen optimalen effekt beim verlegen zu erzielen empfiehlt florim eine 2 mm fugе bei einformatigen verlegungen und 3 mm fugе bei formatkombinationen. Para lograr los máximos resultados en la posa del producto, florim aconseja 2 mm de junta en aplicaciones monoformato y 3 mm en combinaciones de formatos mixtos. - ДЛЯ ОПТИМАЛЬНОЙ УКЛАДКИ - FLORIM РЕКОМЕНДУЕТ ВЫДЕРЖИВАТЬ ЗАЗОР 2 мм ДЛЯ МОНОФОРМАТА И 3 мм ПРИ СМЕШАННЫХ ФОРМАТАХ.

In relazione alle differenti tecnologie produttive l'accostamento di prodotti con spessori diversi potrebbe presentare delle disomogeneità, se ne sconsiglia pertanto l'abbinamento. / Due to the different production technologies, contiguous installation of products with different thickness may give a non-homogeneous result. For this reason we do not recommend this option. / Vu que différentes technologies de production sont utilisées avec des épaisseurs différentes, des problèmes d'homogénéité pourraient se présenter, il est donc déconseillé de les poser ensemble. / Wegen unterschiedlicher Produktionstechnologien können die Fliesen mit verschiedenen Materialstärken optische Differenzen aufweisen. Von einem direkten Aneinanderlegen wird deshalb abgeraten. / Dadas las diferentes tecnologías productivas, la combinación de productos de diferentes espesores podría dar lugar a heterogeneidad, por lo que se desaconseja mezclarlas. / В связи с различием в технологиях производства, сочетание продукции разной толщины иногда может представлять неоднородность материала. Такие сочетания следует избегать.







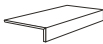

PEZZI SPECIALI/SPECIAL TRIMS/PIÈCES SPÉCIALES/FORMSTÜCKE/PIEZAS ESPECIALES/Специальные изделия

10 mm 3/8" ↑↓

	COLOR	SURFACE	4,6x60 1 ^{45/64} x23 ^{5/8} "  battiscopa	33x120x3 13"x47 ^{1/4} "x1 ^{1/16} "  angolo gradino DX pz/box 2	33x120x3 13"x47 ^{1/4} "x1 ^{1/16} "  gradino pz/box 2	33x120x3 13"x47 ^{1/4} "x1 ^{1/16} "  angolo gradino SX pz/box 2
	BUILD_WHITE TU	LEVIGATO	749301 ◆ FL-01600	749391 ▲ FL-36500	749355 ▲ FL-22600	749427 ▲ FL-36500
		NATURALE	749295 ◆ FL-01600	749385 ▲ FL-31100	749349 ▲ FL-20400	749421 ▲ FL-31100
	BUILD_WHITE GG	LEVIGATO	749325 ◆ FL-01600	749415 ▲ FL-36500	749379 ▲ FL-22600	749451 ▲ FL-36500
		NATURALE	749319 ◆ FL-01600	749409 ▲ FL-31100	749373 ▲ FL-20400	749445 ▲ FL-31100
	BUILD_WHITE CE	NATURALE	767519 ◆ FL-01600	767536 ▲ FL-31100	767528 ▲ FL-20400	767544 ▲ FL-31100
		SOFT	767523 ◆ FL-01600	767540 ▲ FL-31100	767532 ▲ FL-20400	767548 ▲ FL-31100
	BUILD_BONE TU	LEVIGATO	749302 ◆ FL-01600	749392 ▲ FL-36500	749356 ▲ FL-22600	749428 ▲ FL-36500
		NATURALE	749296 ◆ FL-01600	749386 ▲ FL-31100	749350 ▲ FL-20400	749422 ▲ FL-31100
	BUILD_BONE GG	LEVIGATO	749326 ◆ FL-01600	749416 ▲ FL-36500	749380 ▲ FL-22600	749452 ▲ FL-36500
		NATURALE	749320 ◆ FL-01600	749410 ▲ FL-31100	749374 ▲ FL-20400	749446 ▲ FL-31100
	BUILD_BONE CE	NATURALE	767520 ◆ FL-01600	767537 ▲ FL-31100	767529 ▲ FL-20400	767545 ▲ FL-31100
		SOFT	767525 ◆ FL-01600	767541 ▲ FL-31100	767533 ▲ FL-20400	767549 ▲ FL-31100
BUILDTech/2.0 	BUILD_MUD TU	LEVIGATO	749305 ◆ FL-01600	749395 ▲ FL-36500	749359 ▲ FL-22600	749431 ▲ FL-36500
		NATURALE	749299 ◆ FL-01600	749389 ▲ FL-31100	749353 ▲ FL-20400	749425 ▲ FL-31100
	BUILD_MUD GG	LEVIGATO	749329 ◆ FL-01600	749419 ▲ FL-36500	749383 ▲ FL-22600	749455 ▲ FL-36500
		NATURALE	749323 ◆ FL-01600	749413 ▲ FL-31100	749377 ▲ FL-20400	749449 ▲ FL-31100
	BUILD_MUD CE	NATURALE	767521 ◆ FL-01600	767538 ▲ FL-31100	767530 ▲ FL-20400	767546 ▲ FL-31100
		SOFT	767526 ◆ FL-01600	767542 ▲ FL-31100	767534 ▲ FL-20400	767550 ▲ FL-31100
	BUILD_COAL TU	LEVIGATO	749306 ◆ FL-01600	749396 ▲ FL-36500	749360 ▲ FL-22600	749432 ▲ FL-36500
		NATURALE	749300 ◆ FL-01600	749390 ▲ FL-31100	749354 ▲ FL-20400	749426 ▲ FL-31100
	BUILD_COAL GG	LEVIGATO	749330 ◆ FL-01600	749420 ▲ FL-36500	749384 ▲ FL-22600	749456 ▲ FL-36500
		NATURALE	749324 ◆ FL-01600	749414 ▲ FL-31100	749378 ▲ FL-20400	749450 ▲ FL-31100
	BUILD_COAL CE	NATURALE	767522 ◆ FL-01600	767539 ▲ FL-31100	767531 ▲ FL-20400	767547 ▲ FL-31100
		SOFT	767527 ◆ FL-01600	767543 ▲ FL-31100	767535 ▲ FL-20400	767551 ▲ FL-31100

BUILDTECH/2.0

PEZZI SPECIALI/SPECIAL TRIMS/PIÈCES SPÉCIALES/FORMSTÜCKE/PIEZAS ESPECIALES/Специальные изделия

10 mm 3/8" 	COLOR	SURFACE	20x40x6 <small>7 7/8" x 15 3/4" x 2 1/3"</small>  elemento alle pz/box 4
	BUILD_WHITE TU	STRUTTURATO	749331 ▲ FL-02700
	BUILD_WHITE GG	STRUTTURATO	749343 ▲ FL-02700
	BUILD_BONE TU	STRUTTURATO	749332 ▲ FL-02700
	BUILD_BONE GG	STRUTTURATO	749344 ▲ FL-02700
	BUILD_MUD TU	STRUTTURATO	749335 ▲ FL-02700
	BUILD_MUD GG	STRUTTURATO	749347 ▲ FL-02700
	BUILD_COAL TU	STRUTTURATO	749336 ▲ FL-02700
	BUILD_COAL GG	STRUTTURATO	749348 ▲ FL-02700

BUILDTECH/2.0









FLORM OVERSIZE
magnUm

120x240/120x120/60x120
 Specifica Imballo pag.
 Packaging specifications on page
 Spécifications d'emballage à page
 Verpackungsdetail Seite
 Especificaciones de embalaje a la página
 Информация об упаковке на стр.
176/177

BUILDTECH/2.0	scatola - box			pallet		
	pz	mq	kg	box	mq	kg
60x120	2	1,44	32,00	30	43,20	990
80x80	2	1,28	30,00	40	51,20	1220
40x80	3	0,96	22,00	56	53,76	1260
60x60	3	1,08	24,00	40	43,20	990
30x60	6	1,08	24,00	40	43,20	990

BUILDTECH/2.0	scatola - box			pallet		
	pz	ml	kg	box	mq	kg
4,6x60 battiscopa	14	8,40	8,40	-	-	-

PEZZI SPECIALI/SPECIAL TRIMS/PIÈCES SPÉCIALES/FORMSTÜCKE/PIEZAS ESPECIALES/Специальные изделия

6 mm 1/4" 	COLOR	SURFACE	30x30 11 4/5" x 11 4/5"  mosaico tessere 7,5x7,5 pz/box 11	30x30 11 4/5" x 11 4/5"  muretto tessere 7,5x15 pz/box 11	4,6x60 1 4/5" x 23 5/8"  battiscopa
	BUILD_WHITE CE	NATURALE	767552 ▲ FL-01800	767556 ▲ FL-01800	767560 ◆ FL-01800
	BUILD_BONE CE	NATURALE	767553 ▲ FL-01800	767557 ▲ FL-01800	767561 ◆ FL-01800
	BUILD_MUD CE	NATURALE	767554 ▲ FL-01800	767558 ▲ FL-01800	767562 ◆ FL-01800
	BUILD_COAL CE	NATURALE	767555 ▲ FL-01800	767559 ▲ FL-01800	767563 ◆ FL-01800

BUILDTECH/2.0

BUILDTECH/2.0 OUTDOOR

Vantaggi tecnici - Technical advantages - Avantages techniques Technische Vorteile - Ventajas técnicas - Технические преимущества

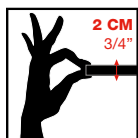

- Lastra monolitica compatta di spessore 2 cm squadrata e rettificata
- Compact monolithic slab 2 cm thick squared and rectified
- Dalle monolithique compacte de 2 cm d'épaisseur, équaree et rectifiée
- Kompakte monolithische Platte, 2 cm dick, rechteckig und scharfkantig geschliffen
- Losa monolítica compacta de 2 cm de espesor, es cuadrada y rectificada.
- Монолитная плотная плита толщиной 2 см, с обрезанными и выровненными кромками

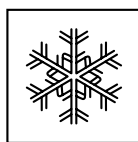

- INGELIVO
- FROST RESISTANT
- INGÉLIF
- FROSTBESTÄNDIG
- RESISTENTE A LA HELADA
- МОРОЗОСТОЙКАЯ

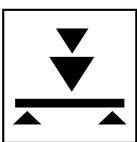

- ELEVATA RESISTENZA AI CARICHI STATICI
- HIGH STATIC LOAD RESISTANCE
- RÉSISTANCE ÉLEVÉE AUX CHARGES STATIQUES
- HOHE STATISCHE BELASTBARKEIT
- ELEVADA RESISTENCIA A LAS CARGAS ESTÁTICAS
- ВЫДЕРЖИВАЕТ БОЛЬШИЕ СТАТИЧЕСКИЕ НАГРУЗКИ

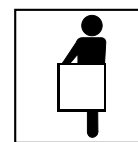

- FACILE DA POSARE
- EASY TO INSTALL
- FACILE À POSER
- VERLEGELEICHT
- FÁCIL DE COLOCAR
- ЛЕГКО УКЛАДЫВАЕТСЯ



- ANTISCIVOLO R11
- ANTI SLIP R11
- ANTIDÉRAPANT R11
- RUTSCHFEST R11
- ANTIDESLIZANTE R11
- НЕСКОЛЬЗКАЯ - R11

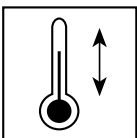

- RESISTENTE AGLI SBALZI TERMICI
- THERMAL SHOCK RESISTANT
- RÉSISTANT AUX ÉCARTS THERMIQUES
- TEMPERATURWECHSELBESTÄNDIG
- RESISTENTE A LAS OSCILACIONES TÉRMICAS
- СТОЙКАЯ К ТЕПЛОВЫМ ПЕРЕПАДАМ



- FACILE DA PULIRE
- EASY TO CLEAN
- FACILE À NETTOYER
- REINIGUNGSEICHT
- FÁCIL DE LIMPIAR
- ЛЕГКО ЧИСТИТСЯ

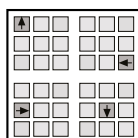

- RIMOVIBILE E RIUTILIZZABILE
- REMOVABLE AND REUSABLE
- DÉMONTABLE ET RÉUTILISABLE
- ENTFERNBAR UND WIEDERVERWENDBAR
- DESMONTABLE Y REUTILIZABLE
- МОЖЕТ СНИМАТЬСЯ И ПОВТОРНО ИСПОЛЬЗОВАТЬСЯ



- INATTACCABILE DA AGENTI CHIMICI E MUFFE
- IMPERVIOUS TO ATTACK BY CHEMICALS OR MOULD
- RÉSISTANT AUX AGENTS CHIMIQUES ET AUX MOISSISSURES
- UNANGREIFBAR DURCH CHEMISCHE STOFFE UND SCHIMMEL
- RESISTENTE A LOS AGENTES QUÍMICOS Y A LOS MOHOS
- НЕ ПОДВЕРГАЕТСЯ ВОЗДЕЙСТВИЮ ХИМИЧЕСКИХ ВЕЩЕСТВ И ПЛЕСЕНИ

Applicazioni - Applications - Applications - Verlegung - Aplicaciones - Применения

- Posa diretta su erba
- Direct installation on grass
- Pose direct sur de l'herbe
- Verlegung direkt auf Rasen
- Colocación directa sobre hierba
- Прямая укладка на траву

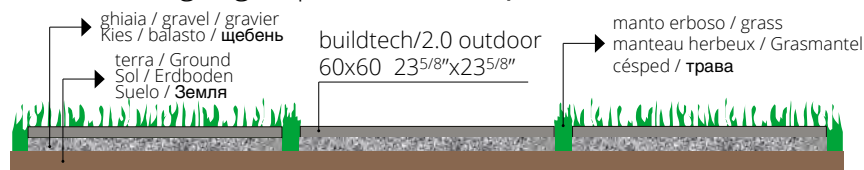

- Posa diretta su ghiaia
- Direct installation over gravel
- Pose direct sur du gravier
- Verlegung direkt auf Kies
- Colocación directa sobre grava
- Прямая укладка на гальку



- Posa su massetto cementizio
- Installation on sand-cement screed
- Pose sur chape ciment
- Verlegung auf Zement-Unterbetonblock
- Colocación sobre contrapiso de hormigón
- Укладка на цементную стяжку

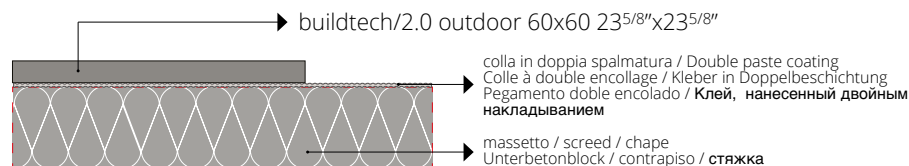

- Posa su piedini fissi o regolabili
- Installation on fixed or adjustable feet
- Pose sur pieds fixes ou réglables
- Verlegung auf feststehende oder regulierbare FüÙe
- Colocación sobre pies fijos o regulables
- Укладка на фиксированных или регулируемых ножках

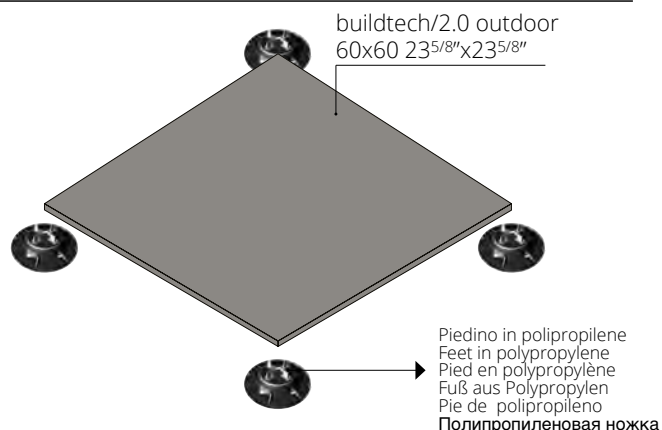

Per le specifiche di utilizzo dei sistemi sopraelevati vedi il sito florim.com
For the specifics on use of raised systems visit the site florim.com
Pour les caractéristiques d'utilisation des systèmes surélevés, voir le site florim.com
Für die Nutzungsbedingungen der Doppelbodensysteme siehe Webseite florim.com
Para las especificaciones de empleo de los sistemas sobreelevados consulte el sitio web florim.com
Технические характеристики систем фальшполов см. на сайте florim.com

Le lastre ceramiche sono sottoposte a un trattamento di compattazione termica che assicura resistenza e durata nel tempo. Il bassissimo assorbimento d'acqua rende perciò il materiale ingelivo. Ciò può comportare ristagni d'acqua superficiali anche per materiale installato a regola d'arte. / Ceramic tiles undergo a compacting thermal treatment that ensures resistance and durability. The low level of water absorption makes the slabs frost resistant. This could result in superficial water stagnations even if materials are installed in a workmanlike manner. / Les carreaux de céramique subissent un traitement thermique qui assure résistance et durabilité. Le bas niveau d'absorption d'eau rend les dalles résistant au gel. Il pourrait en résulter des stagnations d'eau superficielles, même si les dalles ont été installées dans les règles de l'art. / Die Keramikplatten werden einer thermischen Verdichtung unterzogen, welche die Widerstandsfähigkeit und Langlebigkeit sichert. Die extrem niedrige Wasseraufnahme macht das Material frostsicher. Die hohe Materialdichte kann, auch bei einer perfekten Verlegung, eine längere Abtrocknungszeit von angestaubtem Wasser zur Folge haben. / Las baldosas cerámicas se someten a un tratamiento de compactación térmica que asegura resistencia y durabilidad. La baja absorción de agua hace que las baldosas resistan al hielo. Esto podría resultar en estancamientos superficiales de agua, incluso si los materiales están instalados según las reglas del arte. / Керамическая плитка подвергается термическому уплотнению, что обеспечивает ей прочность и износостойкость. За счёт очень низкого водопоглощения она не промерзает, при этом даже при правильной укладке возможны застои воды на поверхности плитки.

BUILD_WHITE TU

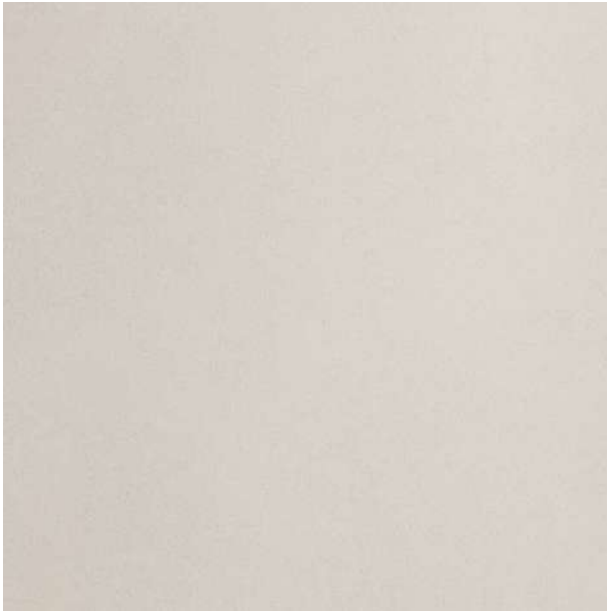

BUILD_BONE TU

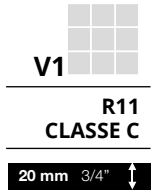
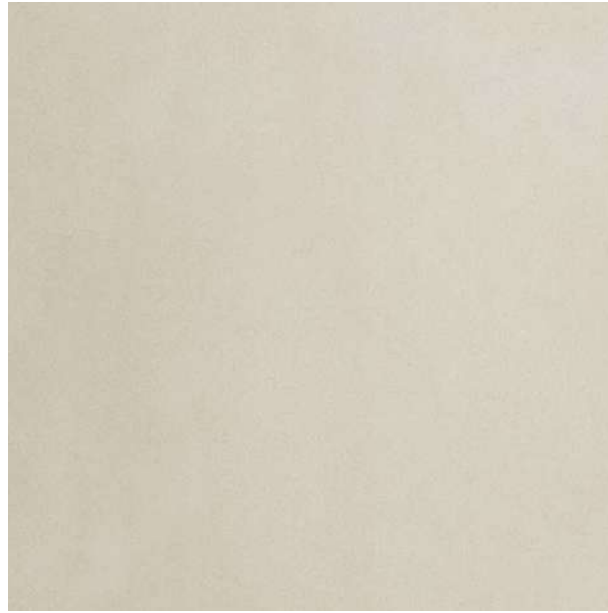

BUILD_MUD TU

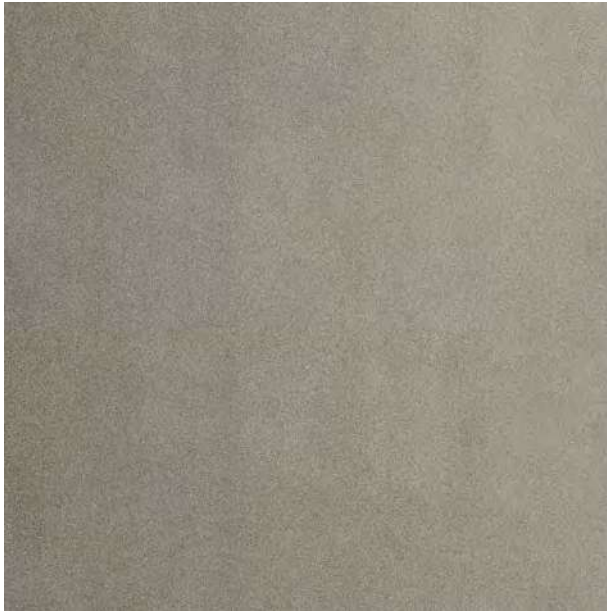

PEZZI SPECIALI

Special trims/Pièces spèciales/Formstücke
Piezas especiales/СПЕЦИАЛЬНЫЕ ИЗДЕЛИЯ
pag 166/169

GRES FINE PORCELLANATO

FINE PORCELAIN STONEWARE/GRES CERAME FIN/FEINSTEINZEUG-KOLLEKTIONEN/GRES PORCELANICO FINO/ФАРФОРОВЫЙ КЕРАМОГРАНИТ
SQUADRATO - SQUARED - EQUARRI - REKTIFIZIERT - ESCUADRADO - КАЛИБРОВАННАЯ

20 mm 3/4" ↑↓

	COLOR	SURFACE	60x120 23 ^{5/8"} x47 ^{1/4"}	60x60 23 ^{5/8"} x23 ^{5/8"}
BUILDTECH/2.0		BUILD_WHITE TU	STRUTTURATO	762792 ■ FL-10300
		BUILD_BONE TU	STRUTTURATO	-
		BUILD_MUD TU	STRUTTURATO	-
				749133 ■ FL-07700
				749136 ■ FL-07700



Recycled material content certification

20mm
BUILD_BONE - BUILD_MUD - BUILD_COAL

ISO 10545-4	RESISTENZA ALLA FLESSIONE IN N/mm ² N/mm ² FLEXURAL STRENGTH TEST / RESISTENCIA A LA FLEXION EN N/mm ² / BIEGEFESTIGKEIT IN N/mm ² / RESISTENCIA A LA FLEXION EN N/mm ² / УСТОЙЧИВОСТЬ К ИЗГИБУ В Н/мм ²	valore medio 52 N/mm ²
	Forza di rottura in N (sp. > 7,5 mm) Breaking strength in N (thickness > 7,5 mm) / Force de rupture en N (ép. > 7,5 mm) / Bruchlast in N (Dicke > 7,5 mm) / Fuerza de rotura en N (gr. > 7,5 mm) / Разрушающее усилие, Н (толщ. > 7,5 мм)	valore medio 14000 N

BUILDTECH/2.0	scatola - box			pallet		
	pz	mq	kg	box	mq	kg
60x120 20mm	1	0,72	32,00	30	21,60	990
60x60 20mm	2	0,72	32,00	30	21,60	990

BUILDTECH/2.0 OUTDOOR

BUILD_WHITE CE

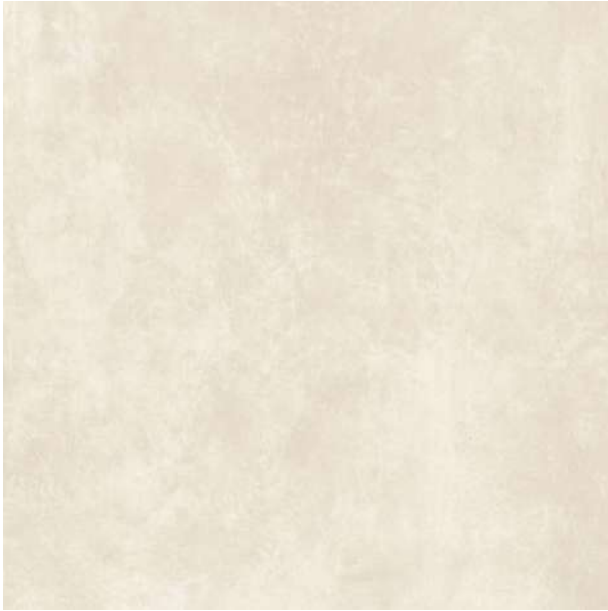

BUILD_BONE CE

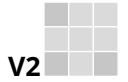

R11
CLASSE C

20 mm 3/4" ↑↓

BUILD_MUD CE

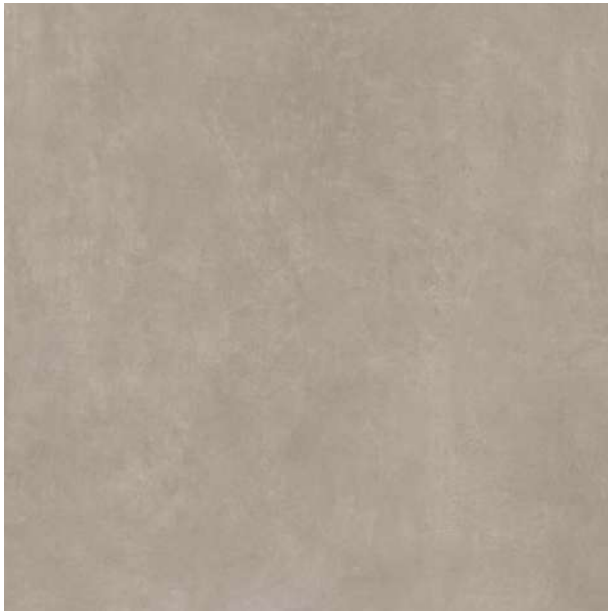





BUILD_COAL CE



GRES FINE PORCELLANATO

FINE PORCELAIN STONEWARE/GRES CERAME FIN/FEINSTEINZEUG-KOLLEKTIONEN/GRES PORCELANICO FINO/ФАРФОРОВЫЙ КЕРАМОГРАНИТ
SQUADRATO - SQUARED - EQUARRI - REKTIFIZIERT - ESCUADRADO - КАЛИБРОВАННАЯ

20 mm 3/4" ↑↓

	COLOR	SURFACE	60x120 23 ^{5/8"} x47 ^{1/4"}	60x60 23 ^{5/8"} x23 ^{5/8"}
	BUILD_WHITE CE	STRUTTURATO	765296 ■ FL-10300	765300 ■ FL-07700
	BUILD_BONE CE	STRUTTURATO	765297 ■ FL-10300	765301 ■ FL-07700
	BUILD_MUD CE	STRUTTURATO	765298 ■ FL-10300	765302 ■ FL-07700
	BUILD_COAL CE	STRUTTURATO	765299 ■ FL-10300	765303 ■ FL-07700

BUILDTECH/2.0

BUILD_BONE GG



BUILD_MUD GG

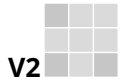



R11
CLASSE C

20 mm 3/4" ↑↓

GRES FINE PORCELLANATO

FINE PORCELAIN STONWARE/GRES CERAME FIN/FEINSTEINZEUG-KOLLEKTIONEN/GRES PORCELANICO FINO/ФАРФОРОВЫЙ КЕРАМОГРАНИТ
SQUADRATO - SQUARED - EQUARRI - REKTIFIZIERT - ESCUADRADO - КАЛИБРОВАННАЯ

20 mm 3/4" ↑↓	COLOR	SURFACE	60x60 23 ^{5/8"} x23 ^{5/8"}
	BUILD_BONE GG	STRUTTURATO	749137 ■ FL-07700
	BUILD_MUD GG	STRUTTURATO	749140 ■ FL-07700

BUILDTECH/2.0

PEZZI SPECIALI

Special trims/Pièces spéciales/Formstücke
Piezas especiales/СПЕЦИАЛЬНЫЕ ИЗДЕЛИЯ
pag 166/169

BUILDTECH/2.0	scatola - box			pallet		
	pz	mq	kg	box	mq	kg
60x120 20mm	1	0,72	32,00	30	21,60	990
60x60 20mm	2	0,72	32,00	30	21,60	990



Recycled material content certification

20mm
BUILD_BONE - BUILD_MUD - BUILD_COAL

ISO 10545-4	RESISTENZA ALLA FLESSIONE IN N/mm ² N/mm ² FLEXURAL STRENGTH TEST / RESISTANCE A LA FLEXION EN N/mm ² / BIEGEFESTIGKEIT IN N/mm ² / RESISTENCIA A LA FLEXION EN N/mm ² / УСТОЙЧИВОСТЬ К ИЗГИБУ В Н/мм ²	valore medio 52 N/mm ²
	Forza di rottura in N (sp. > 7,5 mm) Breaking strength in N (thickness > 7,5 mm) / Force de rupture en N (ép. > 7,5 mm) / Bruchlast in N (Dicke > 7,5 mm) / Fuerza de rotura en N (gr. > 7,5 mm) / Разрушающее усилие, Н (толщ > 7,5 мм)	valore medio 14000 N

BUILDTECH/2.0

CREAM



MUSTARD





6 mm 1/4" 
 FLORIM OVERSIZE
 magnum

GRES PORCELLANATO DECORATO

DECORATED PORCELAIN TILES/GRÈS CÉRAMÉ DÉCORÉ/VERZIERTES FEINSTEINZEUG/GRES PORCELÁNICO DECORADO/ДЕКОРИРОВАННЫЙ КЕРАМОГРАНИТ

SQUADRATO - SQUARED - EQUARRI - REKTIFIZIERT - ESCUADRADO - КАЛИБРОВАННАЯ

6 mm 1/4" 		COLOR	SURFACE	120x280 47 ^{1/4"} x110 ^{1/4"}	120x240 47 ^{1/4"} x94 ^{1/2"}	120x120 47 ^{1/4"} x47 ^{1/4"}	60x120 23 ^{5/8"} x47 ^{1/4"}
BUILDTECH/2.0		CREAM	GLOSSY	766859 ■ FL-36500	766674 ■ FL-36500	766879 ■ FL-32200	766900 ■ FL-30000
			NATURALE	766849 ■ FL-27900	766660 ■ FL-27900	766869 ■ FL-25700	766890 ■ FL-23600
		MUSTARD	GLOSSY	766858 ■ FL-36500	766672 ■ FL-36500	766878 ■ FL-32200	766899 ■ FL-30000
			NATURALE	766848 ■ FL-27900	766659 ■ FL-27900	766868 ■ FL-25700	766889 ■ FL-23600

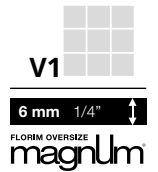

SCARLET

CRIMSON



GRES PORCELLANATO DECORATO

DECORATED PORCELAIN TILES/GRÈS CÉRAMÉ DÉCORÉ/VERZIERTES FEINSTEINZEUG/GRES PORCELÁNICO DECORADO/ДЕКОРИРОВАННЫЙ КЕРАМОГРАНИТ
SQUADRATO - SQUARED - EQUARRI - REKTIFIZIERT - ESCUADRADO - КАЛИБРОВАННАЯ

6 mm 1/4" ↑↓		COLOR	SURFACE	120x280 47 ^{1/8"} x110 ^{1/4"}	120x240 47 ^{1/8"} x94 ^{1/2"}	120x120 47 ^{1/8"} x47 ^{1/8"}	60x120 23 ^{5/8"} x47 ^{1/8"}
BUILDTech/2.0		SCARLET	GLOSSY	766862 ■ FL-36500	766677 ■ FL-36500	766882 ■ FL-32200	766903 ■ FL-30000
			NATURALE	766852 ■ FL-27900	766663 ■ FL-27900	766872 ■ FL-25700	766893 ■ FL-23600
		CRIMSON	GLOSSY	766863 ■ FL-36500	766678 ■ FL-36500	766883 ■ FL-32200	766904 ■ FL-30000
			NATURALE	766853 ■ FL-27900	766665 ■ FL-27900	766873 ■ FL-25700	766894 ■ FL-23600

BUILDTECH/2.0

FUCHSIA



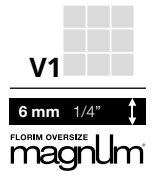

BURGUNDY



GRES PORCELLANATO DECORATO

DECORATED PORCELAIN TILES/GRÈS CÉRAMÉ DÉCORÉ/VERZIERTES FEINSTEINZEUG/GRES PORCELÁNICO DECORADO/ДЕКОРИРОВАННЫЙ КЕРАМОГРАНИТ
SQUADRATO - SQUARED - EQUARRI - REKTIFIZIERT - ESCUADRADO - КАЛИБРОВАННАЯ

6 mm 1/4" ↓		COLOR	SURFACE	120x280 47 ^{1/4"} x110 ^{1/4"}	120x240 47 ^{1/4"} x94 ^{1/2"}	120x120 47 ^{1/4"} x47 ^{1/4"}	60x120 23 ^{5/8"} x47 ^{1/4"}
BUILDTECH/2.0		FUCHSIA	GLOSSY	766865 ■ FL-36500	766680 ■ FL-36500	766885 ■ FL-32200	766906 ■ FL-30000
			NATURALE	766855 ■ FL-27900	766667 ■ FL-27900	766875 ■ FL-25700	766896 ■ FL-23600
		BURGUNDY	GLOSSY	766864 ■ FL-36500	766679 ■ FL-36500	766884 ■ FL-32200	766905 ■ FL-30000
			NATURALE	766854 ■ FL-27900	766666 ■ FL-27900	766874 ■ FL-25700	766895 ■ FL-23600

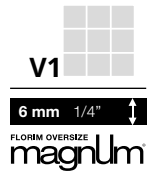

SKY

MIDNIGHT



GRES PORCELLANATO DECORATO

DECORATED PORCELAIN TILES/GRÈS CÉRAMÉ DÉCORÉ/VERZIERTES FEINSTEINZEUG/GRES PORCELÁNICO DECORADO/ДЕКОРИРОВАННЫЙ КЕРАМОГРАНИТ
SQUADRATO - SQUARED - EQUARRI - REKTIFIZIERT - ESCUADRADO - КАЛИБРОВАННАЯ

6 mm 1/4" ↑↓		COLOR	SURFACE	120x280 47 ^{1/4"} x110 ^{1/4"}	120x240 47 ^{1/4"} x94 ^{1/2"}	120x120 47 ^{1/4"} x47 ^{1/4"}	60x120 23 ^{5/8"} x47 ^{1/4"}
BUILDTech/2.0		SKY	GLOSSY	766861 ■ FL-36500	766676 ■ FL-36500	766881 ■ FL-32200	766902 ■ FL-30000
			NATURALE	766851 ■ FL-27900	766662 ■ FL-27900	766871 ■ FL-25700	766892 ■ FL-23600
		MIDNIGHT	GLOSSY	766860 ■ FL-36500	766675 ■ FL-36500	766880 ■ FL-32200	766901 ■ FL-30000
			NATURALE	766850 ■ FL-27900	766661 ■ FL-27900	766870 ■ FL-25700	766891 ■ FL-23600

TEAL

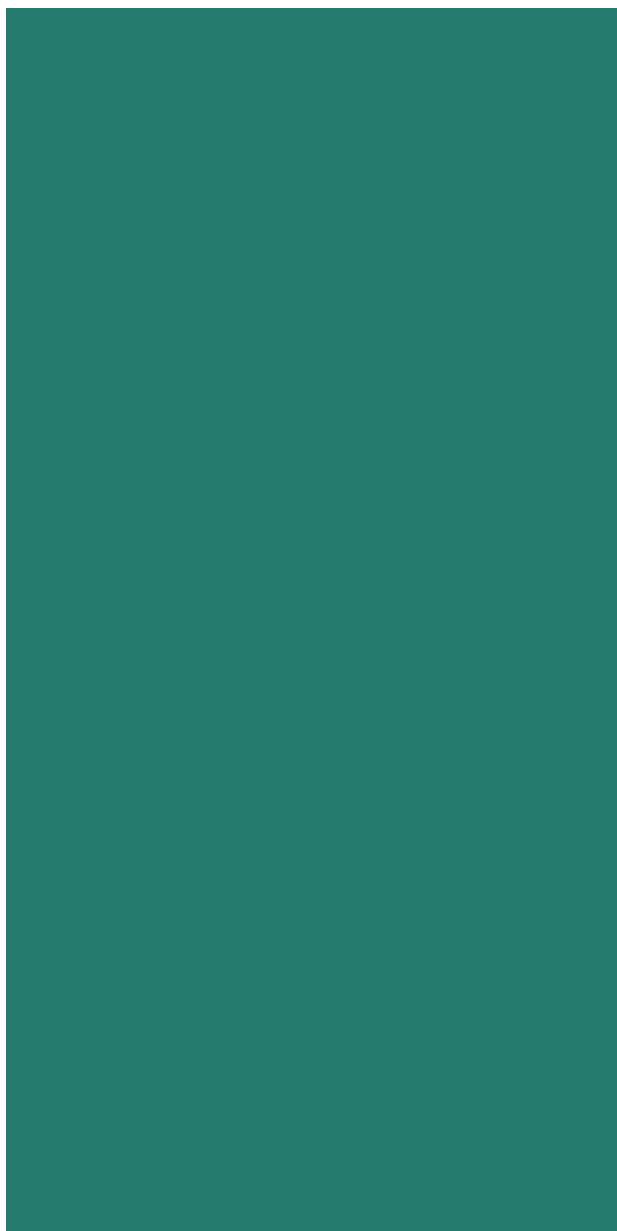

BOTTLE

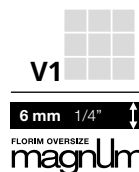
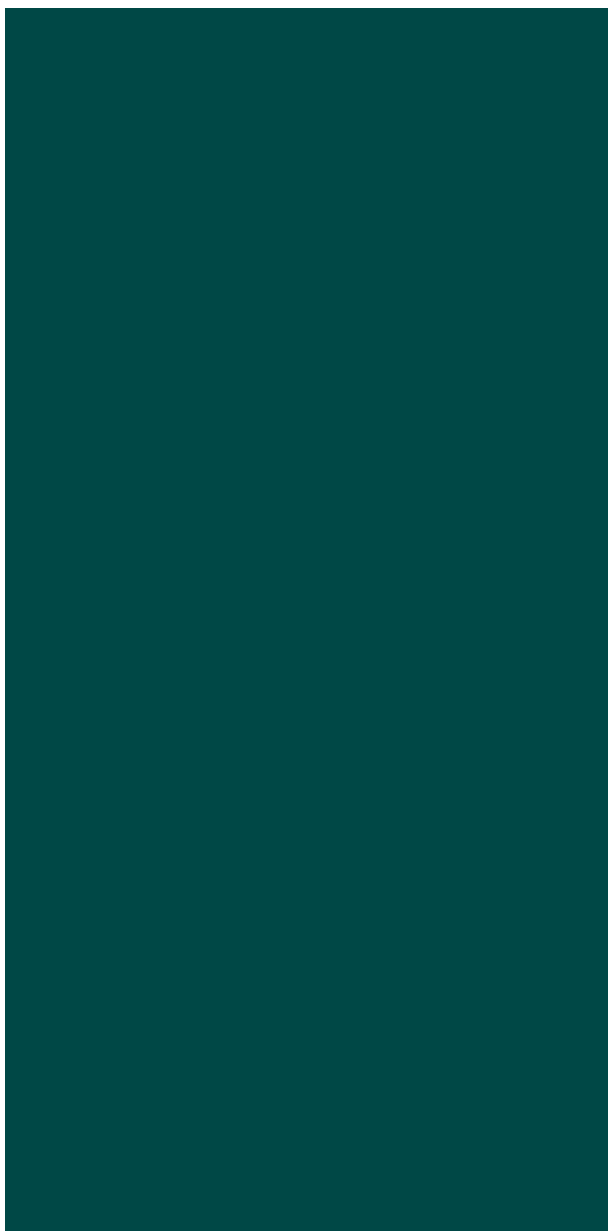

GRES PORCELLANATO DECORATO

DECORATED PORCELAIN TILES/GRÈS CÉRAMÉ DÉCORÉ/VERZIERTES FEINSTEINZEUG/GRES PORCELÁNICO DECORADO/ДЕКОРИРОВАННЫЙ КЕРАМОГРАНИТ

SQUADRATO - SQUARED - EQUARRI - REKTIFIZIERT - ESCUADRADO - КАЛИБРОВАННАЯ

6 mm 1/4" ↑↓	COLOR	SURFACE	120x280 47 ^{1/8"} x110 ^{1/4"}	120x240 47 ^{1/8"} x94 ^{1/2"}	120x120 47 ^{1/8"} x47 ^{1/8"}	60x120 23 ^{5/8"} x47 ^{1/4"}
BUILDTECH/2.0	TEAL	GLOSSY	766856 ■ FL-36500	766668 ■ FL-36500	766876 ■ FL-32200	766897 ■ FL-30000
		NATURALE	766846 ■ FL-27900	766657 ■ FL-27900	766866 ■ FL-25700	766886 ■ FL-23600
	BOTTLE	GLOSSY	766857 ■ FL-36500	766671 ■ FL-36500	766877 ■ FL-32200	766898 ■ FL-30000
		NATURALE	766847 ■ FL-27900	766658 ■ FL-27900	766867 ■ FL-25700	766888 ■ FL-23600

Lastre decorate destinate esclusivamente al rivestimento di pareti interne. / Decorated panels designed exclusively for tiling interior walls. / Dalles décorées, exclusivement destinées au revêtement de parois intérieures. Verzierte Platten, ausschließlich zur Verkleidung von Innenwänden bestimmt. Losas decoradas destinadas exclusivamente al revestimiento de paredes interiores. / Декорированная плитка больших размеров, предназначенная исключительно для внутренней облицовки стен.

Gres porcellanato decorato: florim indica di stoccare il materiale in magazzini coperti o al riparo da agenti atmosferici / Florim recommends to stock the goods in covered warehouses, do not expose to the elements. Florim conseille de stocker le matériel dans des entrepôts couverts ou à l'abri des agents atmosphériques / Florim empfiehlt, das Material in geschlossenen Lagern oder in vor Witterungseinflüssen geschützten Bereichen zu lagern. / Florim indica almacenar el material en locales cubiertos o protegido de los agentes atmosféricos. / FLORIM РЕКОМЕНДУЕТ ХРАНИТЬ ДАННЫЙ МАТЕРИАЛ В ЗАКРЫТЫХ СКЛАДСКИХ ПОМЕЩЕНИЯХ ИЛИ В ПОМЕЩЕНИЯХ, ЗАЩИЩЕННЫХ ОТ АТМОСФЕРНЫХ ОСАДКОВ

FLORIM OVERSIZE
magnUm

120x280/120x240/120x120/60x120

Specifica Imballo pag.

Packaging specifications on page

Spécifications d'emballage à page

Verpackungsdetail Seite

Especificaciones de embalaje a la página

Информация об упаковке на стр.

176/177

GRES PORCELLANATO DECORATO

DECORATED PORCELAIN TILES/GRES CÉRAMÉ DÉCORÉ/VERZIERTES FEINSTEINZEUG/GRES PORCELÁNICO DECORADO/ДЕКОРИРОВАННЫЙ КЕРАМОГРАНИТ

AVVERTENZE / WARNINGS / AVERTISSEMENTS / ADVERTENCIAS / HINWEISE / ПРЕДУПРЕЖДЕНИЕ / 警告

Lastre decorate con innovative tecniche artigianali destinate esclusivamente al rivestimento di pareti interne... Destinazione d'uso: Recommended applications: Domaine d'application: Anwendungsgebiete: USO PREVISTO: НАЗНАЧЕНИЕ: 用途

Nella movimentazione evitare il contatto con materiali abrasivi e lo strofinamento con altre lastre... MOVIMENTAZIONE HANDLING MANUTENTION TRANSPORT UND HANDHABUNG DESPLAZAMIENTO PEREMICHENIE 搬运

Verificare che il piano di appoggio sia perfettamente stabile, pianare, pulito e privo di ogni asperità... TAGLIO/DORING CUTTING/FRILLING DÉCOUPE/TROUS SCHNEIDEN/BOHREN CORTE/ORIFICIO РЕЗКА/ОТВЕРСТИЕ 切割/钻孔

Si consiglia l'uso di distanziatori livellanti tradizionali. È possibile utilizzare i livellanti a vite dotati di guarnizione protettiva... POSA INSTALLATION POSE VERLEGEN COLOCACIÓN УКЛАДКА 铺设

Florim indica di stoccare il materiale in magazzini coperti o al riparo da agenti atmosferici... INDICAZIONI GENERALI GENERAL INSTRUCTIONS INDICATIONS GÉNÉRALES ALLGEMEINE HINWEISE INDICACIONES GENERALES ОБЩИЕ УКАЗАНИЯ 一般性说明

Si consiglia l'uso di soli sigillanti cementizi a grana fine e spatole in materiale plastico... STUCCATURA GROUTING REALISATION DES JOINTS VERFUGEN REJUNTADO ЗАТІРКА

Avere cura di pulire i residui prima dell'indurimento dello stucco con acqua e spugna non abrasiva... PULIZIA POST POSA POST-INSTALLATION CLEANING NETTOYAGE APRES POSE ERSTREINIGUNG LIMPIEZA TRAS LA COLOCACIÓN ЧИСТКА ПОСЛЕ УКЛАДКИ 铺设后的清洁

Utilizzare detergenti neutri e/o acqua, pulendo con straccio in microfibra o spugna morbida... PULIZIA QUOTIDIANA DAILY MAINTENANCE ENTRETIEN QUOTIDIEN UNTERHALTSREINIGUNG LIMPIEZA COTIDIANA ЕЖЕДНЕВНАЯ ОЧИСТКА 日常清洁

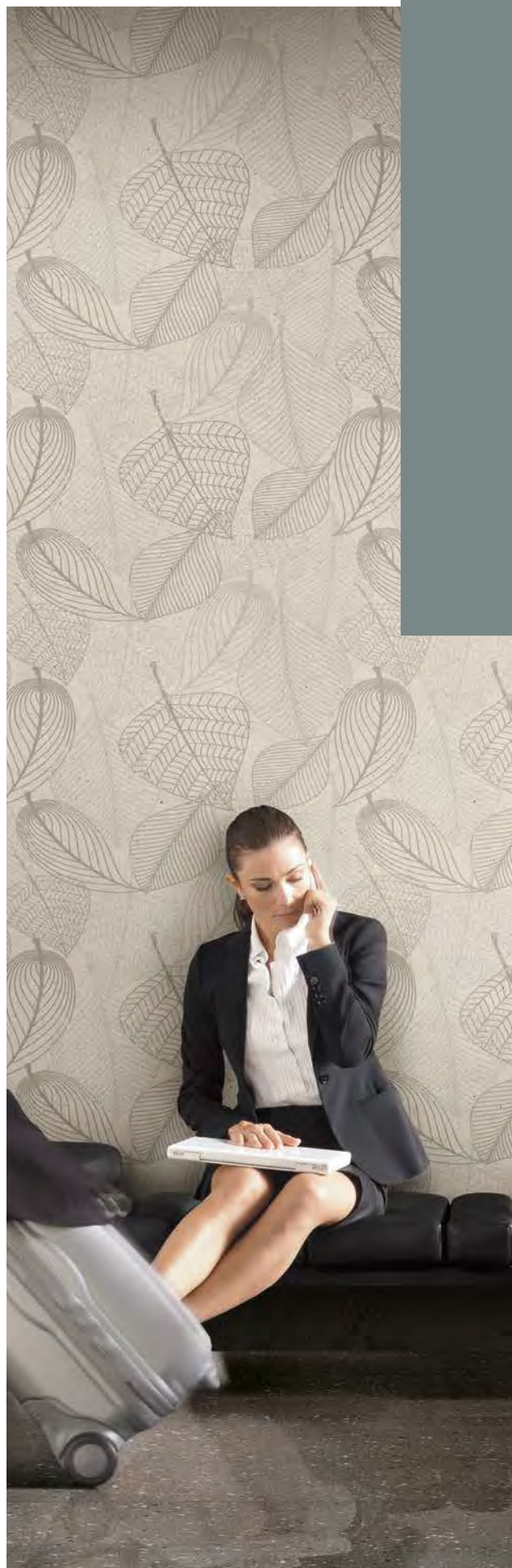

EARTHTECH

gres fine porcellanato
fine porcelain stoneware
grès cérame fin
feinsteinzeug-kollektionen
gres porcelánico fino
фарфоровый керамогранит





EARTHTECH

Terra e tecnologia sono divenuti un binomio sempre più reale, portatore di una nuova consapevolezza che parte dalla nostra storia per creare un futuro responsabile. **Earthtech** è la sintesi di una mentalità contemporanea, capace di essere soggetto attivo nelle regole della costruzione circolare. Un prodotto tecnico tutta massa che amalgama insieme superficie e spessore, nato dalla miscelazione spontanea di piccoli frammenti e pigmenti di diversi colori. **Sei cromie** essenziali in accordo con le sfumature degli elementi naturali caratterizzano questa serie che propone tonalità facilmente abbinabili tra loro. **Ground** e **Flakes** sono le due famiglie estetiche in cui si sviluppa la collezione attraverso una palette cromatica neutra e due colori intensi, giallo e arancione. Nuove finiture, comfort e glossy-bright, ne arricchiscono le possibilità di utilizzo.

Earth and technology have increasingly become a truly dual concept, bearer of a new awareness coming from our past to create a responsible future. **Earthtech** is the synthesis of a contemporary mindset, capable of being an active player within the rules of circular construction. It is a full-bodied technical product which mixes together surface and thickness, born from the spontaneous blending of small fragments and pigments of different colours. **Six** essential hues in harmony with shades of natural elements are the distinguishing features of this series which offers easily matchable tones. **Ground** and **Flakes** are the two aesthetic families in which the collection develops, through a neutral colour palette and two intense colours, yellow and orange. New finishes, Comfort and Glossy bright enhance their potential uses.

La terre et la technologie forment désormais un binôme de plus en plus concret, porteur d'une nouvelle prise de conscience qui part de notre histoire pour créer un futur responsable. **Earthtech** est la synthèse d'une mentalité moderne, à même de jouer un rôle actif dans les règles de la construction circulaire. Un produit technique pleine masse qui amalgame surface et épaisseur, né du mélange spontané de petits fragments et pigments de diverses couleurs. **Six colorations** essentielles en accord avec les nuances des éléments naturels caractérisent cette série qui propose des teintes pouvant facilement être combinées. **Ground** et **flakes** sont les deux familles esthétiques au sein desquelles se développe la collection à travers une palette chromatique neutre et deux couleurs intenses, le jaune et l'orange. De nouvelles finitions, Comfort et Glossy bright, enrichissent les possibilités d'utilisation.

Erde und Technologie wurden zu einer immer reelleren Kombination, zum Träger eines neuen Bewusstseins, das unsere Geschichte als Ausgangspunkt für die Schaffung einer verantwortungsbewussten Zukunft nimmt. **Earthtech** ergibt sich aus einer zeitgenössischen Mentalität, die bei den Regeln zur Kreislaufbauwirtschaft eine aktive Rolle spielt. Ein ganzscherbiges technisches Produkt, das Oberfläche und Masse vermergt und aus der spontanen Mischung kleiner Fragmente und verschiedenfarbiger Pigmente entsteht. **Sechs Farben** widerspiegeln die Nuancen der Naturelemente und zeichnen diese Serie mit ihren untereinander leicht kombinierbaren Farbtönen aus. **Ground** und **Flakes** sind zwei ästhetische Varianten, in denen sich die Kollektion durch eine neutrale Farbpalette und zwei intensive Farben, gelb und orange, entwickelt. Neue Oberflächen, Comfort und Glossy-Bright, vervielfältigen ihre Einsatzmöglichkeiten.

La tierra y la tecnología se han convertido en un binomio cada vez más real, portador de una nueva sensibilidad que echa raíces en nuestra historia para crear un futuro responsable. **Earthtech** es la síntesis de una forma de pensar contemporánea, capaz de participar activamente en la economía circular del sector de la construcción. Un producto técnico toda masa que conjuga superficie y grosor, fruto de la mezcla espontánea de pequeños fragmentos y pigmentos de varios colores. **Seis colores** básicos, acordes con los matices cromáticos de los elementos naturales, componen esta serie caracterizada por tonalidades fáciles de combinar entre sí. **Ground** y **flakes** son las dos familias estéticas en las que se articula la colección, por medio de una paleta cromática neutra y dos colores intensos: el amarillo y el naranja. Se enriquece con los nuevos acabados Comfort y Glossy-bright, que amplían sus posibilidades de uso.

Земля и технологии – это все более реальный бином, заключающий в себе новое сознание, которое начинается с нашей истории и направлено на создание ответственного будущего. Серия **Earthtech** представляет собой синтез современного образа мышления, выступающий в качестве “активного субъекта” в рамках строительства замкнутого цикла. Технический окрашенный в массу материал, гармонично соединяющий воедино поверхность и корпус, созданный в результате произвольного смешения мелких фрагментов и пигментов разных цветов. **Шесть основных цветов**, соответствующих оттенкам природных элементов, характеризуют эту серию, предлагающую легко сочетающиеся между собой тональности. **Ground** и **Flakes** – это два варианта эстетики, представляющие всю коллекцию, палитра которой состоит из нейтральных хроматических оттенков и двух ярких цветов, желтого и оранжевого. Новые типы поверхности, **Comfort** и **Glossy-Bright**, расширяют возможности использования.

PUMICE_GROUND

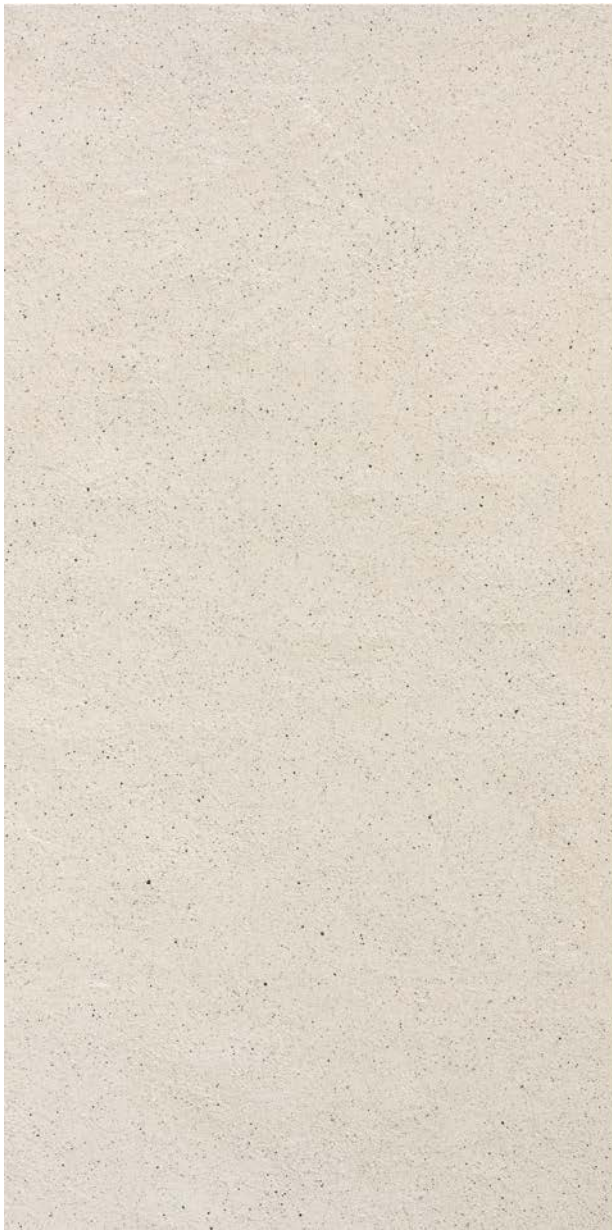

PUMICE_FLAKES



R10
Classe B
(comfort
ground/
flakes)

R11
Classe C
(strutturato
grip)

DCOF>
0,60 Wet
(comfort/
strutturato)

PTV
>36 wet
slider 4S
(comfort
ground/
flakes)

10 mm 3/8" ↑↓

R10
Classe B

DCOF>
0,60 Wet

PTV
>36 wet
slider 4S
(comfort
ground)

6 mm 1/4" ↑↓
FLORIM OVERSIZE
magnUm

GRES FINE PORCELLANATO

FINE PORCELAIN STONEWARE / GRÈS CÉRAME FIN / FEINSTEINZEUG-KOLLEKTIONEN / GRES PORCELÁNICO FINO / фарфоровый керамогранит

SQUADRATO - SQUARED - EQUARRI - REKTIFIZIERT - ESCUADRADO - КАЛИБРОВАННА

10 mm 3/8" ↑↓	COLOR	SURFACE	120x240 47 ^{11/16"} x94 ^{11/21"}	120x120 47 ^{11/16"} x47 ^{11/16"}	60x120 23 ^{5/8"} x47 ^{11/16"}	60x60 23 ^{5/8"} x23 ^{5/8"}	30x60 11 ^{4/5"} x23 ^{5/8"}
EARTHTECH	PUMICE_GROUND	COMFORT	-	-	771567 ■ FL-09100	771608 ■ FL-05800	771614 ■ FL-04900
		STRUTTURATO-GRIP	-	-	-	-	772106 ■ FL-04900
	PUMICE_FLAKES	COMFORT	771166 ■ FL-12400	771165 ■ FL-10300	771167 ■ FL-09100	-	-
		GLOSSY-BRIGHT	771441 ■ FL-15100	771588 ■ FL-12400	771599 ■ FL-10500	-	-
6 mm 1/4" ↑↓	COLOR	SURFACE	120x280 47 ^{11/16"} x110 ^{11/16"}	120x240 47 ^{11/16"} x94 ^{11/21"}	120x120 47 ^{11/16"} x47 ^{11/16"}	60x120 23 ^{5/8"} x47 ^{11/16"}	
EARTHTECH	PUMICE_GROUND	COMFORT	771449 ■ FL-10800	771459 ■ FL-09900	771607 ■ FL-08400	771631 ■ FL-07700	

DESERT_GROUND



DESERT_FLAKES



R10
Classe B
(comfort
ground/
flakes)

R11
Classe C
(strutturato
grip)

DCOF>
0,60 Wet
(comfort/
strutturato)

PTV
>36 wet
slider 4S
(comfort
ground/
flakes)

10 mm 3/8" ↑↓

R10
Classe B

DCOF>
0,60 Wet

PTV
>36 wet
slider 4S
(comfort
ground)

6 mm 1/4" ↑↓
FLORM OVERSIZE
magnium

GRES FINE PORCELLANATO

FINE PORCELAIN STONEWARE / GRÈS CÉRAME FIN / FEINSTEINZEUG-KOLLEKTIONEN / GRES PORCELÁNICO FINO / фарфоровый керамогранит

SQUADRATO - SQUARED - EQUARRI - REKTIFIZIERT - ESCUADRADO - КАЛИБРОВАННА

10 mm 3/8" ↑↓	COLOR	SURFACE	120x240 47 ^{11/16"} x94 ^{1/2"}	120x120 47 ^{11/16"} x47 ^{11/16"}	60x120 23 ^{5/8"} x47 ^{11/16"}	60x60 23 ^{5/8"} x23 ^{5/8"}	30x60 11 ^{4/5"} x23 ^{5/8"}
EARTHTECH	DESERT_GROUND	COMFORT	-	-	771568 ■ FL-09100	771609 ■ FL-05800	771615 ■ FL-04900
		STRUTTURATO-GRIP	-	-	-	-	772107 ■ FL-04900
	DESERT_FLAKES	COMFORT	771436 ■ FL-12400	771583 ■ FL-10300	771594 ■ FL-09100	-	-
		GLOSSY-BRIGHT	771444 ■ FL-15100	771589 ■ FL-12400	771600 ■ FL-10500	-	-
6 mm 1/4" ↑↓	COLOR	SURFACE	120x280 47 ^{11/16"} x110 ^{11/16"}	120x240 47 ^{11/16"} x94 ^{1/2"}	120x120 47 ^{11/16"} x47 ^{11/16"}	60x120 23 ^{5/8"} x47 ^{11/16"}	
EARTHTECH	DESERT_GROUND	COMFORT	771450 ■ FL-10800	771462 ■ FL-09900	771626 ■ FL-08400	771632 ■ FL-07700	

FOG_GROUND



FOG_FLAKES



R10
Classe B
(comfort
ground/
flakes)

R11
Classe C
(strutturato
grip)

DCOF>
0,60 Wet
(comfort/
strutturato)

PTV
>36 wet
slider 4S
(comfort
ground/
flakes)

10 mm 3/8" ↑↓

R10
Classe B

DCOF>
0,60 Wet

PTV
>36 wet
slider 4S
(comfort
ground)

6 mm 1/4" ↑↓

FLORIM OVERSIZE
magnUm

GRES FINE PORCELLANATO

FINE PORCELAIN STONEWARE / GRÈS CÉRAME FIN / FEINSTEINZEUG-KOLLEKTIONEN / GRES PORCELÁNICO FINO / фарфоровый керамогранит

SQUADRATO - SQUARED - EQUARRI - REKTIFIZIERT - ESCUADRADO - КАЛИБРОВАННА

10 mm 3/8" ↑↓		COLOR	SURFACE	120x240 47 ^{11/16"} x94 ^{1/2"}	120x120 47 ^{11/16"} x47 ^{11/16"}	60x120 23 ^{5/8"} x47 ^{11/16"}	60x60 23 ^{5/8"} x23 ^{5/8"}	30x60 11 ^{4/5"} x23 ^{5/8"}
EARTHTECH	FOG_GROUND	COMFORT	-	-	771569 ■ FL-09100	771610 ■ FL-05800	771616 ■ FL-04900	
		STRUTTURATO-GRIP	-	-	-	-	772108 ■ FL-04900	
	FOG_FLAKES	COMFORT	771437 ■ FL-12400	771584 ■ FL-10300	771595 ■ FL-09100	-	-	
		GLOSSY-BRIGHT	771445 ■ FL-15100	771590 ■ FL-12400	771601 ■ FL-10500	-	-	
6 mm 1/4" ↑↓		COLOR	SURFACE	120x280 47 ^{11/16"} x110 ^{11/16"}	120x240 47 ^{11/16"} x94 ^{1/2"}	120x120 47 ^{11/16"} x47 ^{11/16"}	60x120 23 ^{5/8"} x47 ^{11/16"}	
EARTHTECH	FOG_GROUND	COMFORT	771451 ■ FL-10800	771463 ■ FL-09900	771627 ■ FL-08400	771633 ■ FL-07700		

CARBON_GROUND

CARBON_FLAKES



R10
Classe B
(comfort
ground/
flakes)

R11
Classe C
(strutturato
grip)

DCOF>
0,60 Wet
(comfort/
strutturato)

PTV
>36 wet
slider 4S
(comfort
ground/
flakes)

10 mm 3/8" ↑↓

R10
Classe B

DCOF>
0,60 Wet

PTV
>36 wet
slider 4S
(comfort
ground)

6 mm 1/4" ↑↓
FLORM OVERSIZE
magnium

GRES FINE PORCELLANATO

FINE PORCELAIN STONEWARE / GRÈS CÉRAME FIN / FEINSTEINZEUG-KOLLEKTIONEN / GRES PORCELÁNICO FINO / фарфоровый керамогранит

SQUADRATO - SQUARED - EQUARRI - REKTIFIZIERT - ESCUADRADO - КАЛИБРОВАННА

10 mm 3/8" ↑↓		COLOR	SURFACE	120x240 47 ^{1/4"} x94 ^{1/2"}	120x120 47 ^{1/4"} x47 ^{1/4"}	60x120 23 ^{5/8"} x47 ^{1/4"}	60x60 23 ^{5/8"} x23 ^{5/8"}	30x60 11 ^{4/5"} x23 ^{5/8"}
EARTHTECH	■	CARBON_GROUND	COMFORT	-	-	771570 ■ FL-09100	771611 ■ FL-05800	771617 ■ FL-04900
			STRUTTURATO-GRIP	-	-	-	-	772109 ■ FL-04900
	■	CARBON_FLAKES	COMFORT	771438 ■ FL-12400	771585 ■ FL-10300	771596 ■ FL-09100	-	-
			GLOSSY-BRIGHT	771446 ■ FL-15100	771591 ■ FL-12400	771602 ■ FL-10500	-	-
6 mm 1/4" ↑↓		COLOR	SURFACE	120x280 47 ^{1/4"} x110 ^{1/4"}	120x240 47 ^{1/4"} x94 ^{1/2"}	120x120 47 ^{1/4"} x47 ^{1/4"}	60x120 23 ^{5/8"} x47 ^{1/4"}	
EARTHTECH	■	CARBON_GROUND	COMFORT	771452 ■ FL-10800	771464 ■ FL-09900	771628 ■ FL-08400	771634 ■ FL-07700	

SAVANNAH_GROUND



SAVANNAH_FLAKES



R10
Classe B
(comfort
ground/
flakes)

R11
Classe C
(strutturato
grip)

DCOF>
0,60 Wet
(comfort/
strutturato)

PTV
>36 wet
slider 4S
(comfort
ground/
flakes)

10 mm 3/8" ↑↓

R10
Classe B

DCOF>
0,60 Wet

PTV
>36 wet
slider 4S
(comfort
ground)

6 mm 1/4" ↑↓

FLORIM OVERSIZE
magnUm

GRES FINE PORCELLANATO

FINE PORCELAIN STONEWARE / GRÈS CÉRAME FIN / FEINSTEINZEUG-KOLLEKTIONEN / GRES PORCELÁNICO FINO / фарфоровый керамогранит

SQUADRATO - SQUARED - EQUARRI - REKTIFIZIERT - ESCUADRADO - КАЛИБРОВАННА

10 mm 3/8" ↑↓		COLOR	SURFACE	120x240 47 ^{1/4"} x94 ^{1/2"}	120x120 47 ^{1/4"} x47 ^{1/4"}	60x120 23 ^{5/8"} x47 ^{1/4"}	60x60 23 ^{5/8"} x23 ^{5/8"}	30x60 11 ^{4/5"} x23 ^{5/8"}
EARTHTECH	SAVANNAH_GROUND	COMFORT	-	-	771572 ■ FL-09100	771612 ■ FL-05800	771618 ■ FL-04900	
		STRUTTURATO-GRIP	-	-	-	-	772110 ■ FL-04900	
	SAVANNAH_FLAKES	COMFORT	771439 ■ FL-12400	771586 ■ FL-10300	771597 ■ FL-09100	-	-	
		GLOSSY-BRIGHT	771447 ■ FL-15100	771592 ■ FL-12400	771603 ■ FL-10500	-	-	
6 mm 1/4" ↑↓		COLOR	SURFACE	120x280 47 ^{1/4"} x110 ^{1/4"}	120x240 47 ^{1/4"} x94 ^{1/2"}	120x120 47 ^{1/4"} x47 ^{1/4"}	60x120 23 ^{5/8"} x47 ^{1/4"}	
EARTHTECH	SAVANNAH_GROUND	COMFORT	771453 ■ FL-10800	771465 ■ FL-09900	771629 ■ FL-08400	771635 ■ FL-07700		

OUTBACK_GROUND

OUTBACK_FLAKES

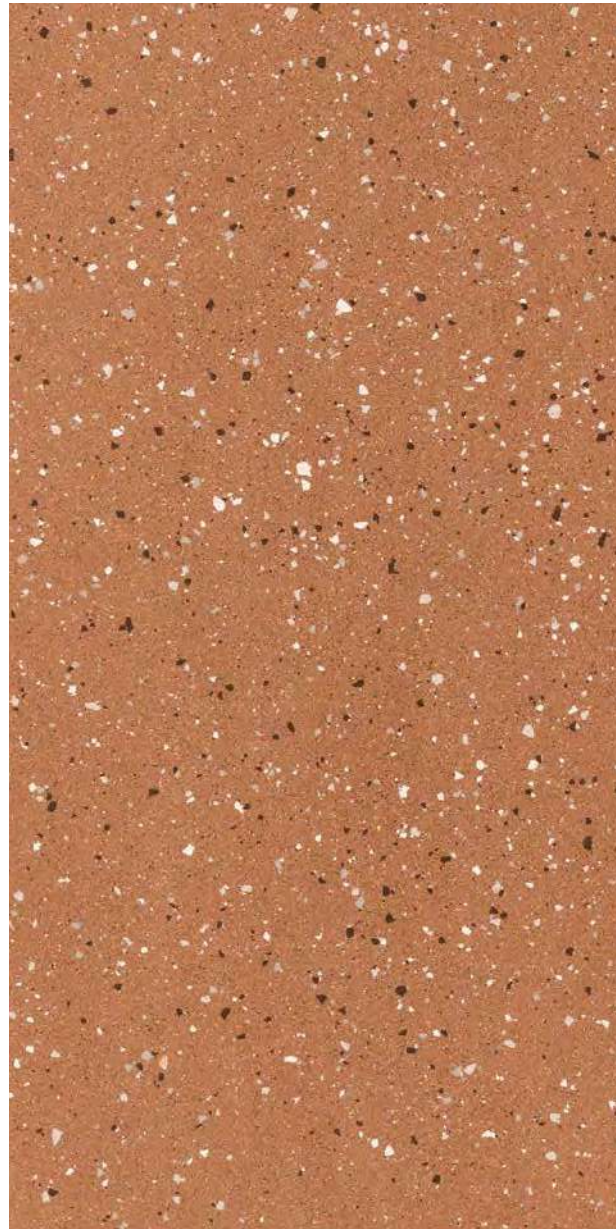

R10
Classe B
(comfort
ground/
flakes)

R11
Classe C
(strutturato
grip)

DCOF>
0,60 Wet
(comfort/
strutturato)

PTV
>36 wet
slider 4S
(comfort
ground/
flakes)

10 mm 3/8" ↓↑

R10
Classe B

DCOF>
0,60 Wet

PTV
>36 wet
slider 4S
(comfort
ground)

6 mm 1/4" ↓↑

FLORM OVERSIZE
magnium

GRES FINE PORCELLANATO

FINE PORCELAIN STONEWARE / GRÈS CÉRAME FIN / FEINSTEINZEUG-KOLLEKTIONEN / GRES PORCELÁNICO FINO / фарфоровый керамогранит

SQUADRATO - SQUARED - EQUARRI - REKTIFIZIERT - ESCUADRADO - КАЛИБРОВАННА

10 mm 3/8" ↓↑	COLOR	SURFACE	120x240 47 ^{1/4"} x94 ^{1/2"}	120x120 47 ^{1/4"} x47 ^{1/4"}	60x120 23 ^{5/8"} x47 ^{1/4"}	60x60 23 ^{5/8"} x23 ^{5/8"}	30x60 11 ^{4/5"} x23 ^{5/8"}
EARTHTECH	OUTBACK_GROUND	COMFORT	-	-	771573 ■ FL-09100	771613 ■ FL-05800	771619 ■ FL-04900
		STRUTTURATO-GRIP	-	-	-	-	772111 ■ FL-04900
	OUTBACK_FLAKES	COMFORT	771440 ■ FL-12400	771587 ■ FL-10300	771598 ■ FL-09100	-	-
		GLOSSY-BRIGHT	771448 ■ FL-15100	771593 ■ FL-12400	771604 ■ FL-10500	-	-
6 mm 1/4" ↓↑	COLOR	SURFACE	120x280 47 ^{1/4"} x110 ^{1/4"}	120x240 47 ^{1/4"} x94 ^{1/2"}	120x120 47 ^{1/4"} x47 ^{1/4"}	60x120 23 ^{5/8"} x47 ^{1/4"}	
EARTHTECH	OUTBACK_GROUND	COMFORT	771454 ■ FL-10800	771466 ■ FL-09900	771630 ■ FL-08400	771636 ■ FL-07700	

PUMICE

DESERT

FOG



Il decoro FRONDS_A è disponibile a magazzino nel colore CARBON GROUND nei seguenti formati 120x280, 120x240 e 60x120.

The FRONDS_A décor is available in stock in the colour CARBON GROUND in the sizes 120x280, 120x240 and 60x120. / Le Décor FRONDS_A est disponible en stock dans la couleur CARBON GROUND dans les formats 120x280, 120x240 e 60x120. / Der Dekor FRONDS_A ist in der Farbe CARBON GROUND in den folgenden Formaten 120x280, 120x240 und 60x120 als Lagerware bestellbar. / La decoración FRONDS_A está disponible en stock en el color CARBON GROUND en los siguientes formatos 120x280, 120x240 y 60x120. Декор FRONDS_A доступен в цвете CARBON GROUND в следующих форматах 120x280, 120x240 и 60x120.

GRES FINE PORCELLANATO

FINE PORCELAIN STONEWARE / GRÈS CÉRAME FIN / FEINSTEINZEUG-KOLLEKTIONEN / GRES PORCELÁNICO FINO / фарфоровый керамогранит

SQUADRATO - SQUARED - EQUARRI - REKTIFIZIERT - ESCUADRADO - КАЛИБРОВАННА

FLORM OVERSIZE
magnUm

6 mm 1/4" ↓	COLOR	SURFACE	120x280	120x240	60x120
			47 ^{1/4"} x110 ^{1/4"}	47 ^{1/4"} x94 ^{1/2"}	23 ^{5/8"} x47 ^{1/4"}
EARTHTECH	FRONDS_A_CARBON_GROUND	COMFORT	772725 ■ FL-31100	772731 ■ FL-31100	-
	FRONDS_A_CARBON_GROUND_1	COMFORT	-	-	772737 ■ FL-29000
	FRONDS_A_CARBON_GROUND_2	COMFORT	-	-	772738 ■ FL-29000
	FRONDS_A_CARBON_GROUND_3	COMFORT	-	-	772739 ■ FL-29000
	FRONDS_A_CARBON_GROUND_4	COMFORT	-	-	772740 ■ FL-29000
	FRONDS_A_CARBON_GROUND_1+2+3+4	COMFORT	-	-	9000236 ■ FL-29000

CARBON

SAVANNAH

OUTBACK



DECORO FRONDS_A

GRES FINE PORCELLANATO

FINE PORCELAIN STONEWARE / GRÈS CÉRAME FIN / FEINSTEINZEUG-KOLLEKTIONEN / GRES PORCELÁNICO FINO / фарфоровый керамогранит

SQUADRATO - SQUARED - EQUARRI - REKTIFIZIERT - ESCUADRADO - КАЛИБРОВАННА

6 mm 1/4" ↓	COLOR	SURFACE	120x280	120x240	60x120
			47 ^{1/4"} x110 ^{1/4"}	47 ^{1/4"} x94 ^{1/2"}	23 ^{5/8"} x47 ^{1/4"}
	FRONDS_A_GROUND	COMFORT	772726 ■ FL-38600	772732 ■ FL-38600	-
EARTHTECH	FRONDS_A_GROUND_1	COMFORT	-	-	772741 ■ FL-36500
	FRONDS_A_GROUND_2	COMFORT	-	-	772742 ■ FL-36500
	FRONDS_A_GROUND_3	COMFORT	-	-	772743 ■ FL-36500
	FRONDS_A_GROUND_4	COMFORT	-	-	772744 ■ FL-36500
	FRONDS_A_GROUND_1+2+3+4	COMFORT	-	-	9000240 ■ FL-36500

FLORIM OVERSIZE
magnuM

I restanti colori sono ordinabili su richiesta tramite i codici on demand della tabella a fianco, specificando il colore desiderato.

The remaining colours can be ordered on request using the "on demand" codes in the opposite table, specifying the desired colour. / Les autres couleurs peuvent être commandées sur demande avec les codes spécifiques du tableau en pièce jointe, en indiquant la couleur souhaitée. / Die restlichen Farben können auf Anfrage unter Verwendung der On-Demand-Codes in der nebenstehenden Tabelle unter Angabe der gewünschten Farbe bestellt werden. / El resto de colores se pueden pedir a través de los códigos de la tabla, eligiendo colores y acabados como desee. / Остальные цвета можно заказать по запросу по кодам в таблице, выбрав нужный цвет.

PUMICE

DESERT

FOG

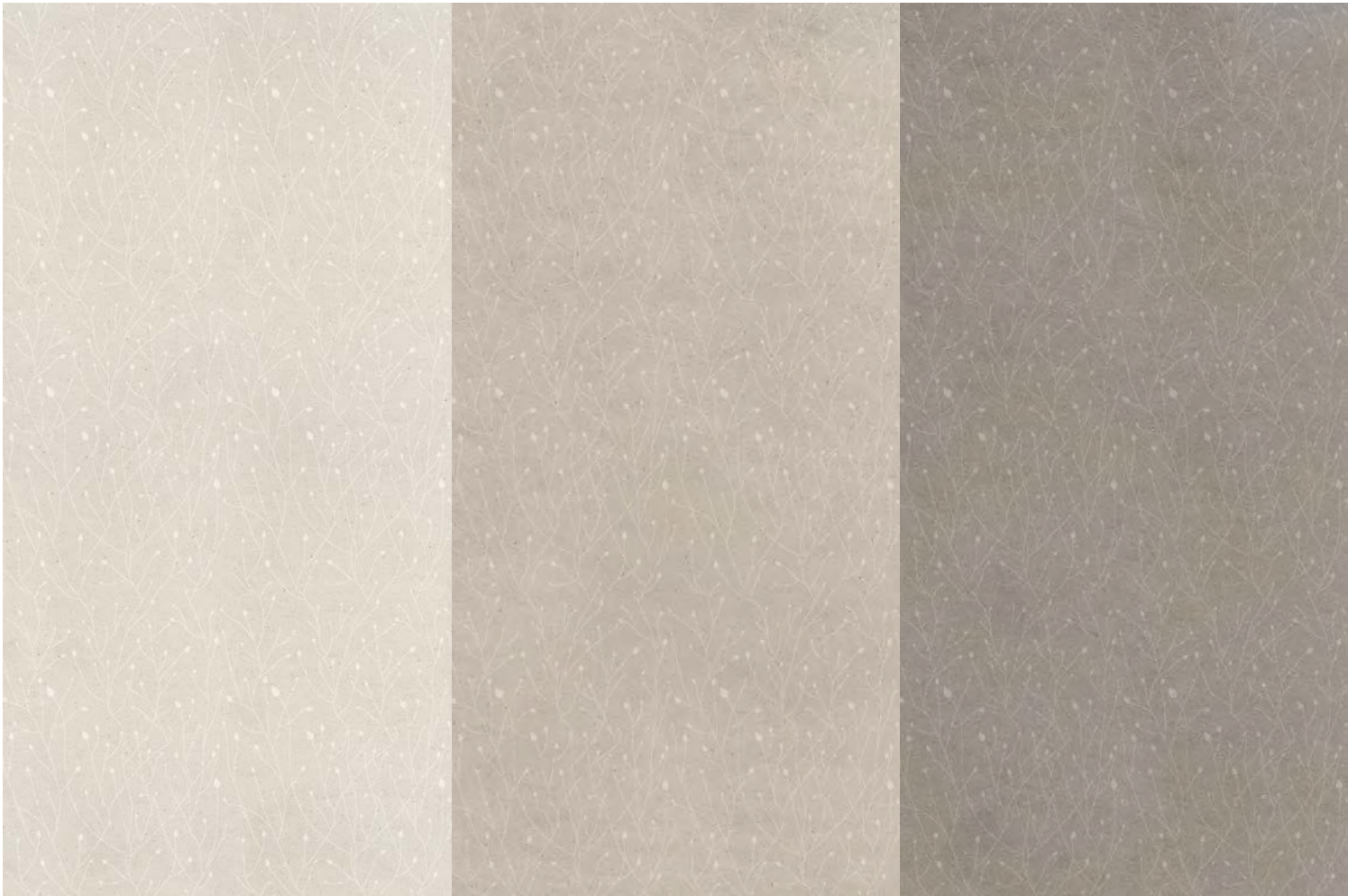

Il decoro FRONDS_B è disponibile a magazzino nel colore DESERT GROUND nei seguenti formati 120x280, 120x240 e 60x120.



The FRONDS_B décor is available in stock in the colour DESERT GROUND in the sizes 120x280, 120x240 and 60x120. / Le Décor FRONDS_B est disponible en stock dans la couleur DESERT GROUND dans les formats 120x280, 120x240 e 60x120. / Der Dekor FRONDS_B ist in der Farbe DESERT GROUND in den folgenden Formaten 120x280, 120x240 und 60x120 als Lagerware bestellbar. / La decoración FRONDS_B está disponible en stock en el color DESERT GROUND en los siguientes formatos 120x280, 120x240 y 60x120. **Декор FRONDS_B доступен в цвете DESERT GROUND в следующих форматах 120x280, 120x240 и 60x120.**

GRES FINE PORCELLANATO

FINE PORCELAIN STONEWARE / GRÈS CÉRAME FIN / FEINSTEINZEUG-KOLLEKTIONEN / GRES PORCELÁNICO FINO / фарфоровый керамогранит

SQUADRATO - SQUARED - EQUARRI - REKTIFIZIERT - ESCUADRADO - КАЛИБРОВАННА

FLORM OVERSIZE
magnUm

6 mm 1/4" 	COLOR	SURFACE	120x280	120x240	60x120
			47 ^{11/16"} x110 ^{1/4"}	47 ^{11/16"} x94 ^{1/2"}	23 ^{5/8"} x47 ^{1/4"}
EARTHTECH 	FRONDS_B_DESERT_GROUND	COMFORT	772727 ■ FL-31100	772733 ■ FL-31100	-
	FRONDS_B_DESERT_GROUND_1	COMFORT	-	-	772745 ■ FL-29000
	FRONDS_B_DESERT_GROUND_2	COMFORT	-	-	772746 ■ FL-29000
	FRONDS_B_DESERT_GROUND_3	COMFORT	-	-	772747 ■ FL-29000
	FRONDS_B_DESERT_GROUND_4	COMFORT	-	-	772748 ■ FL-29000
	FRONDS_B_DESERT_GROUND_1+2+3+4	COMFORT	-	-	9000237 ■ FL-29000

CARBON

SAVANNAH

OUTBACK

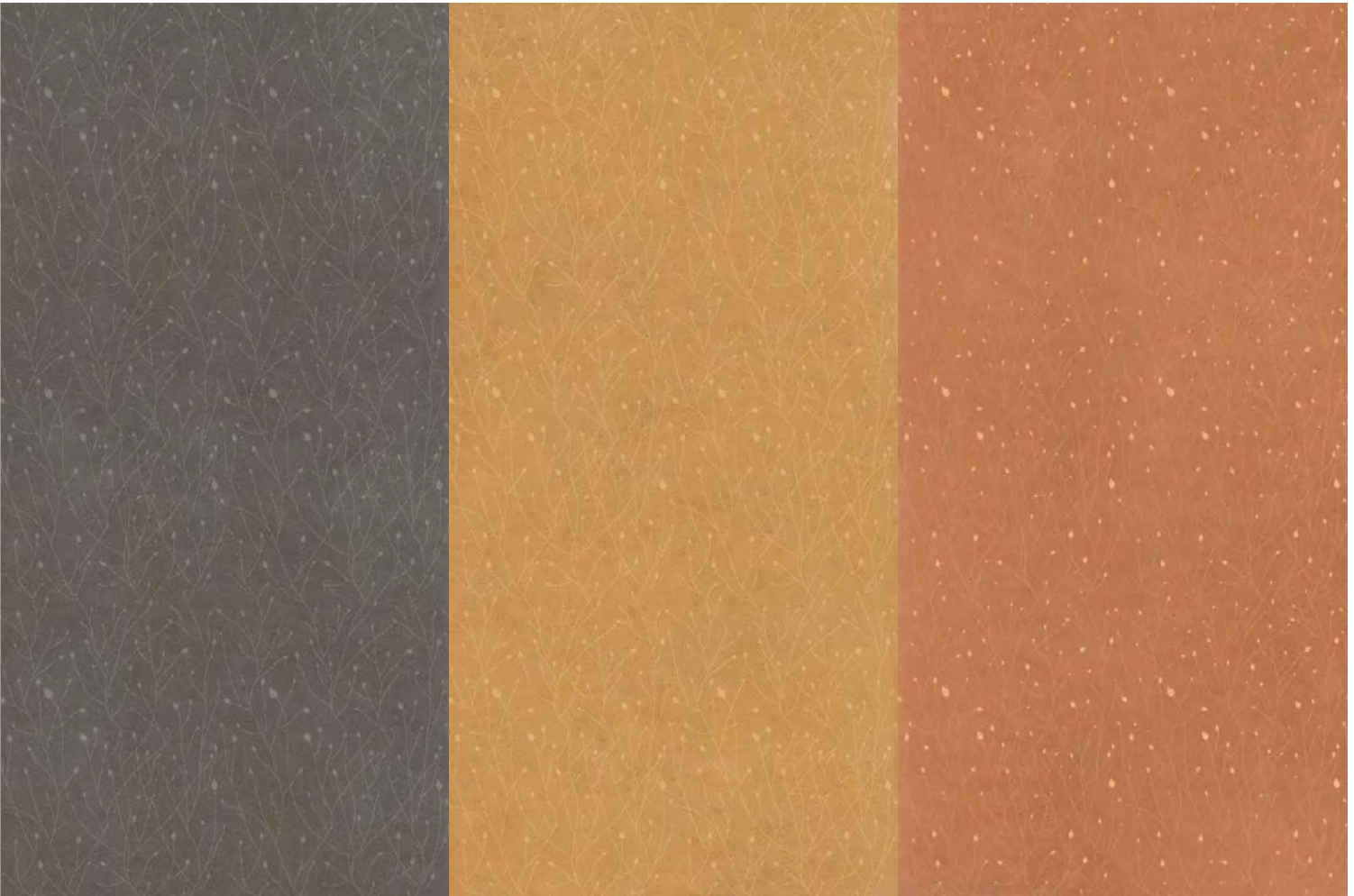

DECORO FRONDS_B

GRES FINE PORCELLANATO

FINE PORCELAIN STONEWARE / GRÈS CÉRAME FIN / FEINSTEINZEUG-KOLLEKTIONEN / GRES PORCELÁNICO FINO / фарфоровый керамогранит
SQUADRATO - SQUARED - EQUARRI - REKTIFIZIERT - ESCUADRADO - КАЛИБРОВАННА

6 mm 1/4" ↓	COLOR	SURFACE	120x280	120x240	60x120
			47 ^{1/4"} x110 ^{1/4"}	47 ^{1/4"} x94 ^{1/2"}	23 ^{5/8"} x47 ^{1/4"}
	FRONDS_B_GROUND	COMFORT	772728 ■ FL-38600	772734 ■ FL-38600	-
EARTHTECH	FRONDS_B_GROUND_1	COMFORT	-	-	772749 ■ FL-36500
	FRONDS_B_GROUND_2	COMFORT	-	-	772750 ■ FL-36500
	FRONDS_B_GROUND_3	COMFORT	-	-	772751 ■ FL-36500
	FRONDS_B_GROUND_4	COMFORT	-	-	772752 ■ FL-36500
	FRONDS_B_GROUND_1+2+3+4	COMFORT	-	-	9000241 ■ FL-36500

FLORIM OVERSIZE
magnum

I restanti colori sono ordinabili su richiesta tramite i codici on demand della tabella a fianco, specificando il colore desiderato.

The remaining colours can be ordered on request using the "on demand" codes in the opposite table, specifying the desired colour. / Les autres couleurs peuvent être commandées sur demande avec les codes spécifiques du tableau en pièce jointe, en indiquant la couleur souhaitée. / Die restlichen Farben können auf Anfrage unter Verwendung der On-Demand-Codes in der nebenstehenden Tabelle unter Angabe der gewünschten Farbe bestellt werden. / El resto de colores se pueden pedir a través de los códigos de la tabla, eligiendo colores y acabados como desee. / Остальные цвета можно заказать по запросу по кодам в таблице, выбрав нужный цвет.

PUMICE

DESERT

FOG

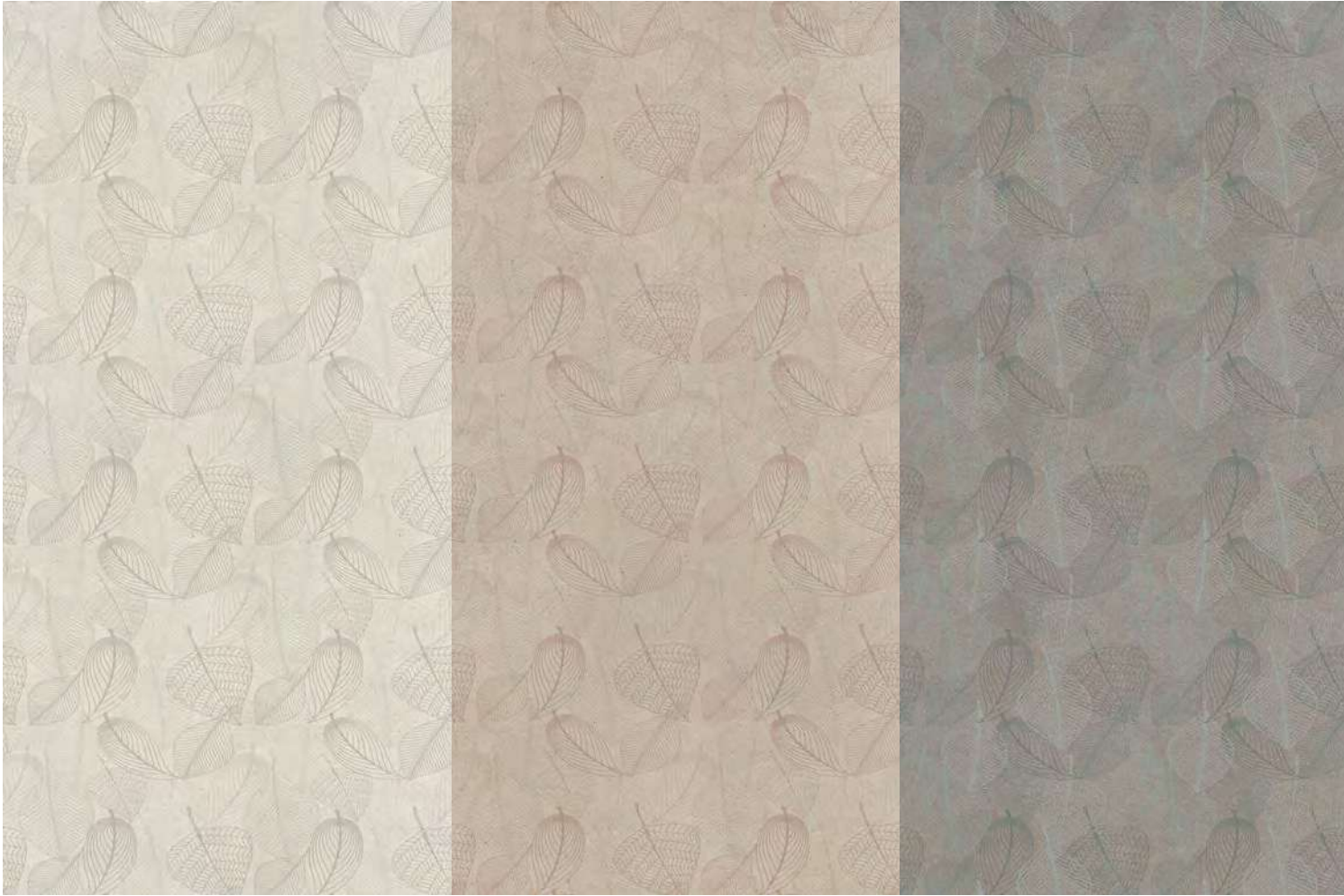

Il decoro LEAVES è disponibile a magazzino nel colore PUMICE GROUND nei seguenti formati 120x280, 120x240 e 60x120.

The LEAVES décor is available in stock in the colour PUMICE GROUND in the sizes 120x280, 120x240 and 60x120. / Le Décor LEAVES est disponible en stock dans la couleur PUMICE GROUND dans les formats 120x280, 120x240 e 60x120. / Der Dekor LEAVES ist in der Farbe PUMICE GROUND in den folgenden Formaten 120x280, 120x240 und 60x120 als Lagerware bestellbar. / La decoración LEAVES está disponible en stock en el color PUMICE GROUND en los siguientes formatos 120x280, 120x240 y 60x120. Декор LEAVES доступен в цвете PUMICE GROUND в следующих форматах 120x280, 120x240 и 60x120.

GRES FINE PORCELLANATO

FINE PORCELAIN STONEWARE / GRÈS CÉRAME FIN / FEINSTEINZEUG-KOLLEKTIONEN / GRES PORCELÁNICO FINO / фарфоровый керамогранит

SQUADRATO - SQUARED - EQUARRI - REKTIFIZIERT - ESCUADRADO - КАЛИБРОВАННА

FLORIM OVERSIZE
magnUm

6 mm 1/4" ↑↓	COLOR	SURFACE	120x280	120x240	60x120
			47 ^{11/16"} x 110 ^{1/4"}	47 ^{11/16"} x 94 ^{1/2"}	23 ^{5/8"} x 47 ^{11/16"}
EARTHTECH	LEAVES_PUMICE_GROUND	COMFORT	772729 ■ FL-31100	772735 ■ FL-31100	-
	LEAVES_PUMICE_GROUND_1	COMFORT	-	-	772753 ■ FL-30000
	LEAVES_PUMICE_GROUND_2	COMFORT	-	-	772754 ■ FL-30000
	LEAVES_PUMICE_GROUND_3	COMFORT	-	-	772755 ■ FL-30000
	LEAVES_PUMICE_GROUND_4	COMFORT	-	-	772756 ■ FL-30000
	LEAVES_PUMICE_GROUND_1+2+3+4	COMFORT	-	-	9000238 ■ FL-30000

CARBON

SAVANNAH

OUTBACK



DECORO LEAVES

GRES FINE PORCELLANATO

FINE PORCELAIN STONEWARE / GRÈS CÉRAME FIN / FEINSTEINZEUG-KOLLEKTIONEN / GRES PORCELÁNICO FINO / фарфоровый керамогранит

SQUADRATO - SQUARED - EQUARRI - REKTIFIZIERT - ESCUADRADO - КАЛИБРОВАННА

6 mm 1/4" ↓	COLOR	SURFACE	120x280 47 ^{1/4"} x110 ^{1/4"}	120x240 47 ^{1/4"} x94 ^{1/2"}	60x120 23 ^{5/8"} x47 ^{1/4"}
EARTHTECH	LEAVES_GROUND	COMFORT	772730 ■ FL-49300	772736 ■ FL-49300	-
	LEAVES_GROUND_1	COMFORT	-	-	772757 ■ FL-47100
	LEAVES_GROUND_2	COMFORT	-	-	772758 ■ FL-47100
	LEAVES_GROUND_3	COMFORT	-	-	772759 ■ FL-47100
	LEAVES_GROUND_4	COMFORT	-	-	772760 ■ FL-47100
	LEAVES_GROUND_1+2+3+4	COMFORT	-	-	9000242 ■ FL-47100

FLORIM OVERSIZE
magnum

I restanti colori sono ordinabili su richiesta tramite i codici on demand della tabella a fianco, specificando il colore desiderato.

The remaining colours can be ordered on request using the "on demand" codes in the opposite table, specifying the desired colour. / Les autres couleurs peuvent être commandées sur demande avec les codes spécifiques du tableau en pièce jointe, en indiquant la couleur souhaitée. / Die restlichen Farben können auf Anfrage unter Verwendung der On-Demand-Codes in der nebenstehenden Tabelle unter Angabe der gewünschten Farbe bestellt werden. / El resto de colores se pueden pedir a través de los códigos de la tabla, eligiendo colores y acabados como desee. / Остальные цвета можно заказать по запросу по кодам в таблице, выбрав нужный цвет.

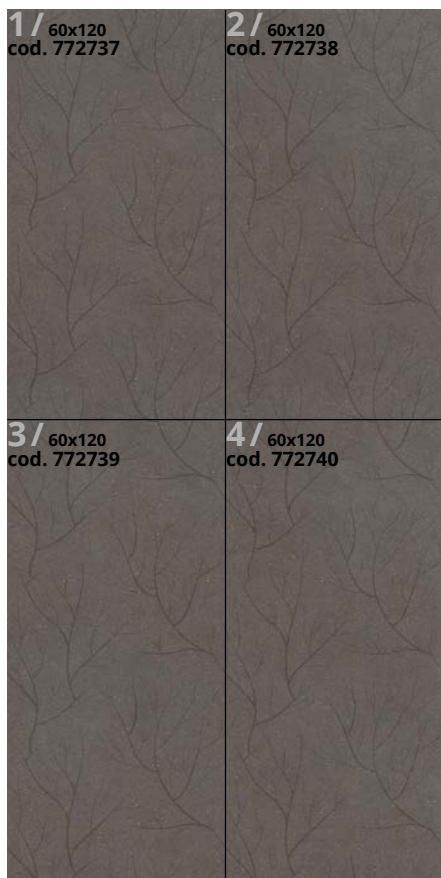

FRONDS_A_CARBON GROUND 1+2+3+4
cod.9000236

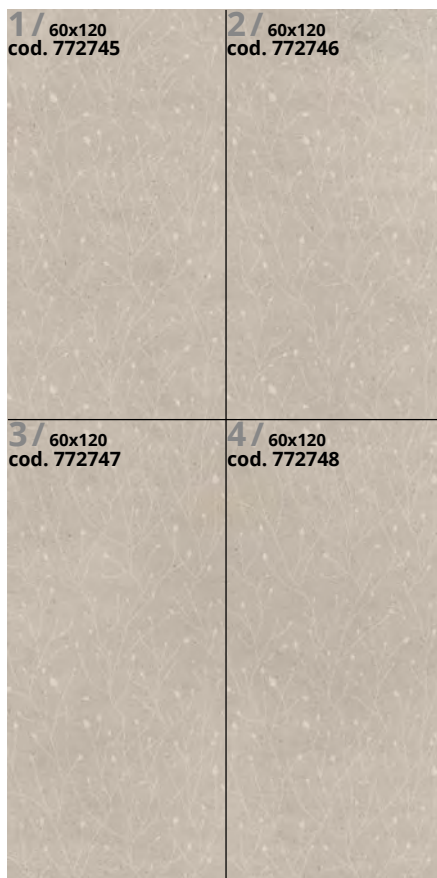

FRONDS_B_DESERT GROUND 1+2+3+4
cod.9000237

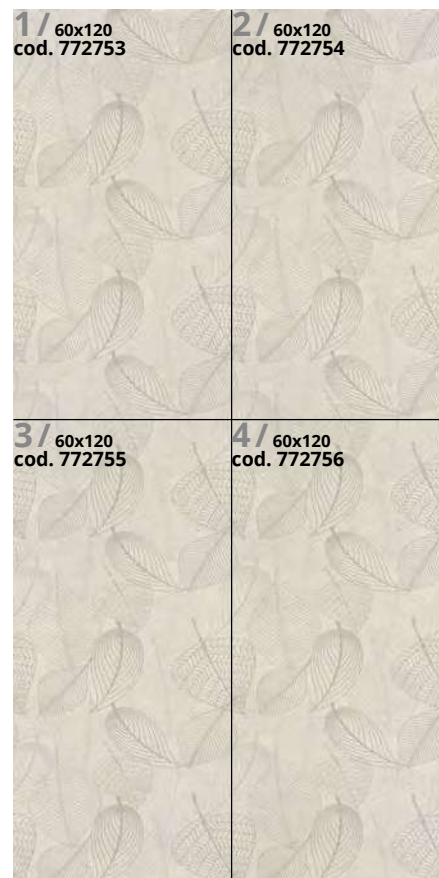

LEAVES_PUMICE GROUND 1+2+3+4
cod.9000238

Ordinando il codice es **9000236** il cliente riceverà 4 scatole, ogni scatola contiene 2 pz di ciascuna grafica. - By ordering code (for example **9000236**) the customer will receive 4 boxes, each box contains 2 pcs of each graphics. - En commandant le code (par exemple **9000236**) le client recevra 4 boites, chaque boite contiendra 2 de chaque graphique. - Bei Bestellung des Codes (z.B. **9000236**) erhält der Kunde 4 Kartons, jeder Karton enthält 2 Stück von jeder Grafik. - Al pedir el código (por ejemplo, **9000236**), el cliente recibirá 4 cajas, cada caja contendrá 2 piezas de cada gráfica. - Заказывая позицию (например, **9000236**), клиент получит 4 коробки, каждая коробка будет содержать 2 штуки каждой графики.

Ordinando il codice es **772737** il cliente riceverà una scatola contenente 2 pezzi della grafica **1**. - By ordering code (for example **772737**) the customers will receive 2 pcs of the design **1**. - En commandant le code (par exemple **772737**) le client recevra 1 boîte, qui contiendra 2 pièces du motif **1**. - Mit der Bestellung des Codes (z.B. **772737**) erhält der Kunde eine Schachtel mit 2 Grafiken **1**. - Al pedir el código (por ejemplo, **772737**), el cliente recibirá una caja que contendrá 2 piezas del gráfico **1**. Заказывая позицию (например, **772737**), клиент получит коробку, содержащую 2 штуки графики **1**.

EARTHTECH/DECORS nel formato 60x120 identificati dai codici **9000 1234** compongono il disegno nel formato 120x240, nel caso di danneggiamento di uno dei 4 pezzi si possono ordinare separatamente facendo riferimento al codice seriale seguito dal numero. / **EARTHTECH/DECORS** size 60x120 identified by item codes **9000 1234** compose the design in size 120x240; should one of the elements be damaged, they can be ordered separately making reference to the serial number followed by number. / **EARTHTECH/DECORS** identifiés pour le format 60x120 avec les codes **9000 1234** composent ensemble le dessin dans le format 120x240 ; en cas d'endommagement d'une des 4 plaques, elle peuvent être commandées séparément en se référant au code de série suivi du numéro. / **EARTHTECH /DECORS** im 60x120-Format, die durch die **9000 1234** - Codes gekennzeichnet sind, bilden das Bild im 120x240-Format. Wenn eines der 4 Teile beschädigt ist, kann es unter Bezugnahme auf die Seriennummer gefolgt von der Kennzahl separat bestellt werden. / **EARTHTECH/DECORS** en el formato 60x120 identificado por los códigos **9000 1234** conforman el diseño en el formato 120x240; Si una de las 4 piezas está dañada, se puede pedir por separado haciendo referencia al código de serie seguido del número. / **EARTHTECH/DECORS** в формате **60x120**, идентифицируемом кодами **9000 1234**, в совокупности составляет формат **120x240**; если одна из 4 частей повреждается, ее можно заказать отдельно, указывая серийный код, за которым следует номер.

Ogni soggetto è caratterizzato da una decorazione che continua da pezzo a pezzo considerando 2 mm di fuga. Prima di passare alla fase di posa stendere i vari soggetti a terra per verificarne la continuità del prodotto. / Each panel features a pattern that continues from piece to piece with a 2 mm joint. Before laying, spread the various panels on the ground to check the pattern's continuity. / Chaque sujet se caractérise par une décoration qui continue d'une pièce à l'autre, en tenant compte de 2 mm de joint. Avant de passer à la phase de pose, étaler les différents sujets au sol, pour en vérifier la continuité de la décoration. / Jedes Muster ist von einem Dekor charakterisiert, das von Platte zu Platte weiterverläuft, wenn man von der 2 mm Fuge absieht. Sollte vor dem Verlegen die einzelnen Muster auf den Boden angeordnet werden, um die Kontinuität des Dekors zu prüfen. / Cada pieza se caracteriza por una decoración que continua de una a otra con una fuga de 2 mm. Antes de pasar a la fase de colocación extender los diferentes motivos sobre el suelo para comprobar la continuidad de la decoración. / Каждая коллекция характеризуется декоративным узором, который продолжается от плитки к плитке, с учетом межплиточного шва шириной 2 мм. перед переходом к фазе укладки необходимо разложить плитку с различными узорами на полу, чтобы проверить непрерывность полученного рисунка.

DECORO TWIST

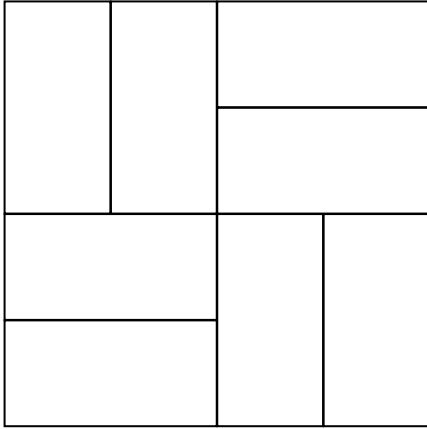











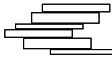

10 mm 3/8" ↑↓	COLOR	30x30 11 ^{4/5} "x11 ^{4/5} "
	TWIST_CARBON_FLAKES GLOSSY-BRIGHT	772716
	PUMICE_FLAKES COMFORT	■ FL-30000
EARTHTECH	TWIST*	772724 ■ FL-36500
6 mm 1/4" ↑↓	COLOR	30x30 11 ^{4/5} "x11 ^{4/5} "
	TWIST*	772723 ■ FL-36500
	EARTHTECH	TWIST*

Il decoro TWIST è disponibile a magazzino nei colori CARBON FLAKES GLOSSY-BRIGHT+PUMICE FLAKES COMFORT nel formato 30x30. / The TWIST décor is available in stock in the colours CARBON FLAKES GLOSSY-BRIGHT+PUMICE FLAKES COMFORT in the size 30x30 cm. / Le décor TWIST est disponible en stock dans les couleurs CARBON FLAKES GLOSSY-BRIGHT + PUMICE FLAKES COMFORT en format 30x30. / Der Dekor TWIST ist in den Farben CARBON FLAKES GLOSSY-BRIGHT + PUMICE FLAKES COMFORT im Format 30x30 als Lagerware bestellbar. / La decoración TWIST está disponible en stock en los colores CARBON FLAKES GLOSSY-BRIGHT + PUMICE FLAKES COMFORT en el formato 30x30. / Декор TWIST доступен в цветах CARBON FLAKES GLOSSY-BRIGHT + PUMICE FLAKES COMFORT в размере 30x30.

*I restanti colori sono ordinabili su richiesta tramite i codici on demand della tabella, scegliendo colori e finiture nel modo in cui si desidera. / The remaining colours can be ordered on request using the "on demand" codes in the table, specifying the desired colours and finishes. / Les autres couleurs peuvent être commandées sur demande avec les codes spécifiques du tableau en pièce jointe, en indiquant les couleurs et les finitions que l'on souhaite. / Die restlichen Farben können auf Anfrage über die On-Demand-Codes der Tabelle bestellt werden, wobei Farben und Oberflächen nach Ihren Wünschen ausgewählt werden. / El resto de colores se pueden pedir a través de los códigos de la tabla, eligiendo colores y acabados como desee. / Остальные цвета можно заказать по запросу по кодам в таблице, выбрав нужные цвета и отделку.

EARTHTECH	scatola - box			pallet		
	pz	mq	kg	box	mq	kg
30x30 twist 10mm	6	0,54	13,00	60	32,40	780
30x30 twist 6mm	9	0,81	12,00	36	29,16	450

EARTHTECH

10 mm 3/8" ↑↓	COLOR	SURFACE	30x30 1 1/4"x1 1/4"	21x40 8 1/4"x15 3/4"
			 mosaico tessere 3x3 pz/box 11	 modulo listello sfalsato
	PUMICE_GROUND	COMFORT	772393 ▲ FL-02000	772417 ■ FL-17200
	PUMICE_FLAKES	COMFORT	772399 ▲ FL-03100	772423 ■ FL-19900
		GLOSSY-BRIGHT	772435 ▲ FL-03800	772429 ■ FL-22600
	DESERT_GROUND	COMFORT	772394 ▲ FL-02000	772418 ■ FL-17200
	DESERT_FLAKES	COMFORT	772400 ▲ FL-03100	772424 ■ FL-19900
		GLOSSY-BRIGHT	772436 ▲ FL-03800	772430 ■ FL-22600
	FOG_GROUND	COMFORT	772395 ▲ FL-02000	772419 ■ FL-17200
	FOG_FLAKES	COMFORT	772401 ▲ FL-03100	772425 ■ FL-19900
		GLOSSY-BRIGHT	772437 ▲ FL-03800	772431 ■ FL-22600
	CARBON_GROUND	COMFORT	772396 ▲ FL-02000	772420 ■ FL-17200
	CARBON_FLAKES	COMFORT	772402 ▲ FL-03100	772426 ■ FL-19900
		GLOSSY-BRIGHT	772438 ▲ FL-03800	772432 ■ FL-22600
	SAVANNAH_GROUND	COMFORT	772397 ▲ FL-02000	772421 ■ FL-17200
	SAVANNAH_FLAKES	COMFORT	772403 ▲ FL-03100	772427 ■ FL-19900
		GLOSSY-BRIGHT	772439 ▲ FL-03800	772433 ■ FL-22600
	OUTBACK_GROUND	COMFORT	772398 ▲ FL-02000	772422 ■ FL-17200
	OUTBACK_FLAKES	COMFORT	772404 ▲ FL-03100	772428 ■ FL-19900
		GLOSSY-BRIGHT	772440 ▲ FL-03800	772434 ■ FL-22600

EARTHTECH











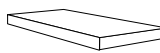
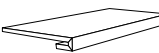
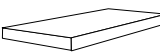

EARTHTECH	scatola - box			pallet		
	pz	m ²	kg	box	m ²	kg
30x60	6	1,08	25,00	40	43,20	1010
60x60	3	1,08	25,00	40	43,20	1010
60x120	2	1,44	34,00	30	43,20	1050
21x40 mod. list. sfalsato	5	0,42	10,00	40	16,80	410











EARTHTECH	scatola - box			pallet		
	pz	ml	kg	box	m ²	kg
4,6x60 battiscopa	14	8,40	8,40	-	-	-

Architectural design

PEZZI SPECIALI/SPECIAL TRIMS/PIÈCES SPÉCIALES/FORMSTÜCKE/PIEZAS ESPECIALES/Специальные изделия

10 mm 3/8" 

	COLOR	SURFACE	4,6x60 1 4/8"x23 3/8"  battiscopa	33x120x3 13"x47 1/4"x1 1/6"  angolo gradino DX pz/box 2	33x120x3 13"x47 1/4"x1 1/6"  gradino pz/box 2	33x120x3 13"x47 1/4"x1 1/6"  angolo gradino SX pz/box 2	
EARTHTECH		PUMICE_GROUND	COMFORT	772441 ◆ FL-01600	772485 ▲ FL-31100	772466 ▲ FL-20400	772491 ▲ FL-31100
		PUMICE_FLAKES	COMFORT	772447 ◆ FL-01600	772499 ▲ FL-31100	772472 ▲ FL-20400	772505 ▲ FL-31100
			GLOSSY-BRIGHT	772453 ◆ FL-01600	772511 ▲ FL-36500	772478 ▲ FL-22600	772517 ▲ FL-36500
		DESERT_GROUND	COMFORT	772442 ◆ FL-01600	772486 ▲ FL-31100	772467 ▲ FL-20400	772492 ▲ FL-31100
		DESERT_FLAKES	COMFORT	772448 ◆ FL-01600	772500 ▲ FL-31100	772473 ▲ FL-20400	772506 ▲ FL-31100
			GLOSSY-BRIGHT	772454 ◆ FL-01600	772512 ▲ FL-36500	772479 ▲ FL-22600	772518 ▲ FL-36500
		FOG_GROUND	COMFORT	772443 ◆ FL-01600	772487 ▲ FL-31100	772468 ▲ FL-20400	772493 ▲ FL-31100
		FOG_FLAKES	COMFORT	772449 ◆ FL-01600	772501 ▲ FL-31100	772474 ▲ FL-20400	772507 ▲ FL-31100
			GLOSSY-BRIGHT	772455 ◆ FL-01600	772513 ▲ FL-36500	772480 ▲ FL-22600	772519 ▲ FL-36500
		CARBON_GROUND	COMFORT	772444 ◆ FL-01600	772488 ▲ FL-31100	772469 ▲ FL-20400	772494 ▲ FL-31100
		CARBON_FLAKES	COMFORT	772450 ◆ FL-01600	772502 ▲ FL-31100	772475 ▲ FL-20400	772508 ▲ FL-31100
			GLOSSY-BRIGHT	772456 ◆ FL-01600	772514 ▲ FL-36500	772481 ▲ FL-22600	772520 ▲ FL-36500
		SAVANNAH_GROUND	COMFORT	772445 ◆ FL-01600	772489 ▲ FL-31100	772470 ▲ FL-20400	772496 ▲ FL-31100
		SAVANNAH_FLAKES	COMFORT	772451 ◆ FL-01600	772503 ▲ FL-31100	772476 ▲ FL-20400	772509 ▲ FL-31100
			GLOSSY-BRIGHT	772457 ◆ FL-01600	772515 ▲ FL-36500	772482 ▲ FL-22600	772521 ▲ FL-36500
		OUTBACK_GROUND	COMFORT	772446 ◆ FL-01600	772490 ▲ FL-31100	772471 ▲ FL-20400	772497 ▲ FL-31100
		OUTBACK_FLAKES	COMFORT	772452 ◆ FL-01600	772504 ▲ FL-31100	772477 ▲ FL-20400	772510 ▲ FL-31100
			GLOSSY-BRIGHT	772458 ◆ FL-01600	772516 ▲ FL-36500	772483 ▲ FL-22600	772522 ▲ FL-36500

		PEZZI SPECIALI/SPECIAL TRIMS PIÈCES SPÉCIALES/FORMSTÜCKE/ PIEZAS ESPECIALES/Специальные изделия				
6 mm 1/4" 		COLOR	SURFACE	30x30 11 4/5"x11 4/5"  mosaico tessere 7,5x7,5 pz/box 11	30x30 11 4/5"x11 4/5"  muretto tessere 7,5x15 pz/box 11	4,6x60 1 4/5"x23 5/8"  battiscopa
EARTHTECH		PUMICE_GROUND	COMFORT	772405 ▲ FL-01800	772523 ▲ FL-01800	772459 ◆ FL-01800
		DESERT_GROUND	COMFORT	772406 ▲ FL-01800	772524 ▲ FL-01800	772460 ◆ FL-01800
		FOG_GROUND	COMFORT	772407 ▲ FL-01800	772525 ▲ FL-01800	772461 ◆ FL-01800
		CARBON_GROUND	COMFORT	772408 ▲ FL-01800	772526 ▲ FL-01800	772462 ◆ FL-01800
		SAVANNAH_GROUND	COMFORT	772409 ▲ FL-01800	772527 ▲ FL-01800	772463 ◆ FL-01800
		OUTBACK_GROUND	COMFORT	772410 ▲ FL-01800	772528 ▲ FL-01800	772464 ◆ FL-01800

FLORM OVERSIZE
magnum

120x280/120x240/120x120/60x120

Specifica Imballo pag.
Packaging specifications on page
Spécifications d'emballage à page
Verpackungsdetail Seite
Especificaciones de embalaje a la página
Информация об упаковке на стр.
176/177

Per un effetto ottimale della posa, florim suggerisce di mantenere 2 mm di fuga per pose monofornato e 3 mm per combinare formati misti - For optimal installation results, florim recommends maintaining a joint of 2 mm 1/12" for single format installations and 3 mm 1/8" to combine mixed formats. - Pour réaliser une pose parfaite, florim suggère de maintenir 2 mm de joint pour la pose des monofornats, et 3 mm pour les combinaisons de formats mixtes. - Um einen optimalen effekt beim verlegen zu erzielen empfiehlt florim eine 2 mm fuge bei einformatigen verlegungen und 3 mm fuge bei formatkombinationen Para lograr los máximos resultados en la posa del producto, florim aconseja 2 mm de junta en aplicaciones monofornato y 3 mm en combinaciones de formatos mixtos - **ДЛЯ ОПТИМАЛЬНОЙ УКЛАДКИ " FLORIM" РЕКОМЕНДУЕТ ВЫДЕРЖИВАТЬ ЗАЗОР 2 ММ ДЛЯ МОНОФОРМАТА И 3 ММ ПРИ СМЕШАННЫХ ФОРМАТАХ.**

In relazione alle differenti tecnologie produttive l'accostamento di prodotti con spessori diversi potrebbe presentare delle disomogeneità, se ne sconsiglia pertanto l'abbinamento. / Due to the different production technologies, contiguous installation of products with different thickness may give a non-homogeneous result. For this reason we do not recommend this option. / Vu que différentes technologies de production sont utilisées avec des épaisseurs différentes, des problèmes d'homogénéité pourraient se présenter, il est donc déconseillé de les poser ensemble. / Wegen unterschiedlicher Produktionstechnologien können die Fliesen mit verschiedenen Materialstärken optische Differenzen aufweisen. Von einem direkten Aneinanderlegen wird deshalb abgeraten. / Dadas las diferentes tecnologías productivas, la combinación de productos de diferentes espesores podría dar lugar a heterogeneidad, por lo que se desaconseja mezclarlas. / **В связи с различием в технологиях производства, сочетание продукции разной толщины иногда может представлять неоднородность материала. Такие сочетания следует избегать.**



EARTHTECH OUTDOOR

Vantaggi tecnici - Technical advantages - Avantages techniques Technische Vorteile - Ventajas técnicas - Технические преимущества

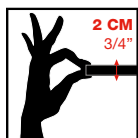

- Lastra monolitica compatta di spessore 2 cm squadrata e rettificata
- Compact monolithic slab 2 cm thick squared and rectified
- Dalle monolithique compacte de 2 cm d'épaisseur, égarrie et rectifiée
- Kompakte monolithische Platte, 2 cm dick, rechteckig und scharfkantig geschliffen
- Losa monolítica compacta de 2 cm de espesor, escuadrada y rectificada.
- Монолитная плотная плита толщиной 2 см, с обрезанными и выровненными кромками

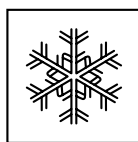

- INGELIVO
- FROST RESISTANT
- INGÉLIF
- FROSTBESTÄNDIG
- RESISTENTE A LA HELADA
- МОРОЗОСТОЙКАЯ

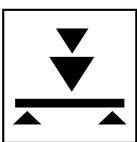

- ELEVATA RESISTENZA AI CARICHI STATICI
- HIGH STATIC LOAD RESISTANCE
- RÉSISTANCE ÉLEVÉE AUX CHARGES STATIQUES
- HOHE STATISCHE BELASTBARKEIT
- ELEVADA RESISTENCIA A LAS CARGAS ESTÁTICAS
- ВЫДЕРЖИВАЕТ БОЛЬШИЕ СТАТИЧЕСКИЕ НАГРУЗКИ

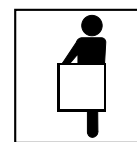

- FACILE DA POSARE
- EASY TO INSTALL
- FACILE À POSER
- VERLEGELEICHT
- FÁCIL DE COLOCAR
- ЛЕГКО УКЛАДЫВАЕТСЯ



- ANTISCIVOLO R11
- ANTI SLIP R11
- ANTIDÉRAPANT R11
- RUTSCHFEST R11
- ANTIDESLIZANTE R11
- НЕСКОЛЬЗКАЯ - R11

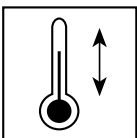

- RESISTENTE AGLI SBALZI TERMICI
- THERMAL SHOCK RESISTANT
- RÉSISTANT AUX ÉCARTS THERMIQUES
- TEMPERATURWECHSELBESTÄNDIG
- RESISTENTE A LAS OSCILACIONES TÉRMICAS
- СТОЙКАЯ К ТЕПЛОВЫМ ПЕРЕПАДАМ



- FACILE DA PULIRE
- EASY TO CLEAN
- FACILE À NETTOYER
- REINIGUNGSLEICHT
- FÁCIL DE LIMPIAR
- ЛЕГКО ЧИСТИТСЯ

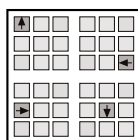

- RIMOVIBILE E RIUTILIZZABILE
- REMOVABLE AND REUSABLE
- DÉMONTABLE ET RÉUTILISABLE
- ENTFERNBAR UND WIEDERVERWENDBAR
- DESMONTABLE Y REUTILIZABLE
- МОЖЕТ СНИМАТЬСЯ И ПОВТОРНО ИСПОЛЬЗОВАТЬСЯ



- INATTACCABILE DA AGENTI CHIMICI E MUFFE
- IMPERVIOUS TO ATTACK BY CHEMICALS OR MOULD
- RÉSISTANT AUX AGENTS CHIMIQUES ET AUX MOISSISSURES
- UNANGREIFBAR DURCH CHEMISCHE STOFFE UND SCHIMMEL
- RESISTENTE A LOS AGENTES QUÍMICOS Y A LOS MOHOS
- НЕ ПОДВЕРГАЕТСЯ ВОЗДЕЙСТВИЮ ХИМИЧЕСКИХ ВЕЩЕСТВ И ПЛЕСЕНИ

Applicazioni - Applications - Applications - Verlegung - Aplicaciones - Применения

- Posa diretta su erba
- Direct installation on grass
- Pose direct sur de l'herbe
- Verlegung direkt auf Rasen
- Colocación directa sobre hierba
- Прямая укладка на траву

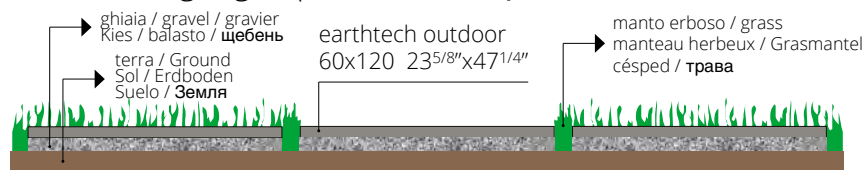

- Posa diretta su ghiaia
- Direct installation over gravel
- Pose direct sur du gravier
- Verlegung direkt auf Kies
- Colocación directa sobre grava
- Прямая укладка на гальку



- Posa su massetto cementizio
- Installation on sand-cement screed
- Pose sur chape ciment
- Verlegung auf Zement-Unterbetonblock
- Colocación sobre contrapiso de hormigón
- Укладка на цементную стяжку

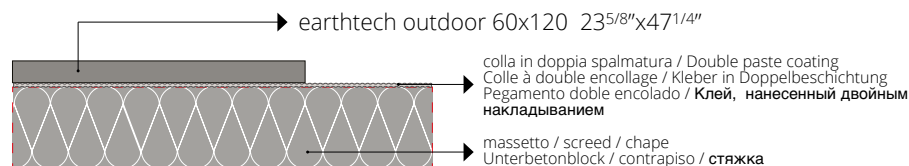

- Posa su piedini fissi o regolabili
- Installation on fixed or adjustable feet
- Pose sur pieds fixes ou réglables
- Verlegung auf feststehende oder regulierbare Füße
- Colocación sobre pies fijos o regulables
- Укладка на фиксированных или регулируемых ножках

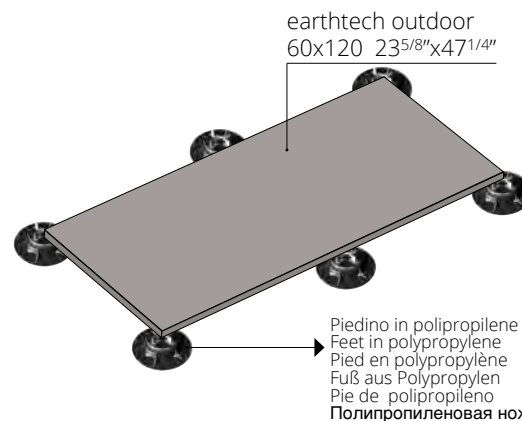

Per le specifiche di utilizzo dei sistemi sopraelevati vedi il sito florim.com
For the specifics on use of raised systems visit the site florim.com
Pour les caractéristiques d'utilisation des systèmes surélevés, voir le site florim.com
Für die Nutzungsbedingungen der Doppelbodensysteme siehe Webseite florim.com
Para las especificaciones de empleo de los sistemas sobreelevados consulte el sitio web florim.com
Технические характеристики систем фальшполов см. на сайте florim.com

Le lastre ceramiche sono sottoposte a un trattamento di compattazione termica che assicura resistenza e durata nel tempo. Il bassissimo assorbimento d'acqua rende perciò il materiale ingelivo. Ciò può comportare ristagni d'acqua superficiali anche per materiale installato a regola d'arte. / Ceramic tiles undergo a compacting thermal treatment that ensures resistance and durability. The low level of water absorption makes the slabs frost resistant. This could result in superficial water stagnations even if materials are installed in a workmanlike manner. / Les carreaux de céramique subissent un traitement thermique qui assure résistance et durabilité. Le bas niveau d'absorption d'eau rend les dalles résistant au gel. Il pourrait en résulter des stagnations d'eau superficielles, même si les dalles ont été installées dans les règles de l'art. / Die Keramikplatten werden einer thermischen Verdichtung unterzogen, welche die Widerstandsfähigkeit und Langlebigkeit sichert. Die extrem niedrige Wasseraufnahme macht das Material frostsicher. Die hohe Materialdichte kann, auch bei einer perfekten Verlegung, eine längere Abtrocknungszeit von angestauntem Wasser zur Folge haben. / Las baldosas cerámicas se someten a un tratamiento de compactación térmica que asegura resistencia y durabilidad. La baja absorción de agua hace que las baldosas resistan al hielo. Esto podría resultar en estancamientos superficiales de agua, incluso si los materiales están instalados según las reglas del arte. / Керамическая плитка подвергается термическому уплотнению, что обеспечивает ей прочность и износостойкость. За счёт очень низкого водопоглощения она не промерзает, при этом даже при правильной укладке возможны застои воды на поверхности плитки.

PUMICE_GROUND



DESERT_GROUND

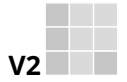

**R11
CLASSE C**

PTV>36 wet
slider 4S

DCOF>
0,42 Wet

20 mm 3/4" ↑↓

FOG_GROUND



CARBON_GROUND



GRES FINE PORCELLANATO

FINE PORCELAIN STONWARE/GRES CERAME FIN/FEINSTEINZEUG-KOLLEKTIONEN/GRES PORCELANICO FINO/ФАРФОРОВЫЙ КЕРАМОГРАНИТ
SQUADRATO - SQUARED - EQUARRI - REKTIFIZIERT - ESCUADRADO - КАЛИБРОВАННАЯ

20 mm 3/4" ↑↓

	COLOR	SURFACE	60x120 23 ^{5/8} "x47 ^{1/4} "
	PUMICE_GROUND	GRIP	771805 ■ FL-10300
	DESERT_GROUND	GRIP	772806 ■ FL-10300
	FOG_GROUND	GRIP	772807 ■ FL-10300
	CARBON_GROUND	GRIP	772808 ■ FL-10300

EARTHTECH

PEZZI SPECIALI

Special trims/Pièces spéciales/Formstücke
Piezas especiales/СПЕЦИАЛЬНЫЕ ИЗДЕЛИЯ
pag 166/169

	RESISTENZA ALLA FLESSIONE IN N/mm ² N/mm ² FLEXURAL STRENGTH TEST / RESISTANCE A LA FLEXION EN N/mm ² / BIEGEFESTIGKEIT IN N/mm ² / RESISTENCIA A LA FLEXION EN N/mm ² / УСТОЙЧИВОСТЬ К ИЗГИБУ В Н/мм ²	valore medio 52 N/mm ²
	Forza di rottura in N (sp. > 7,5 mm) Breaking strength in N (thickness > 7,5 mm) / Force de rupture en N (ép. > 7,5 mm) / Bruchlast in N (Dicke > 7,5 mm) / Fuerza de rotura en N (g. > 7,5 mm) / Разрушающее усилие, Н (толщ. > 7,5 мм)	valore medio 14000 N

EARTHTECH	scatola - box			pallet		
	pz	mq	kg	box	mq	kg
60x120 20mm	1	0,72	32,30	30	21,60	990

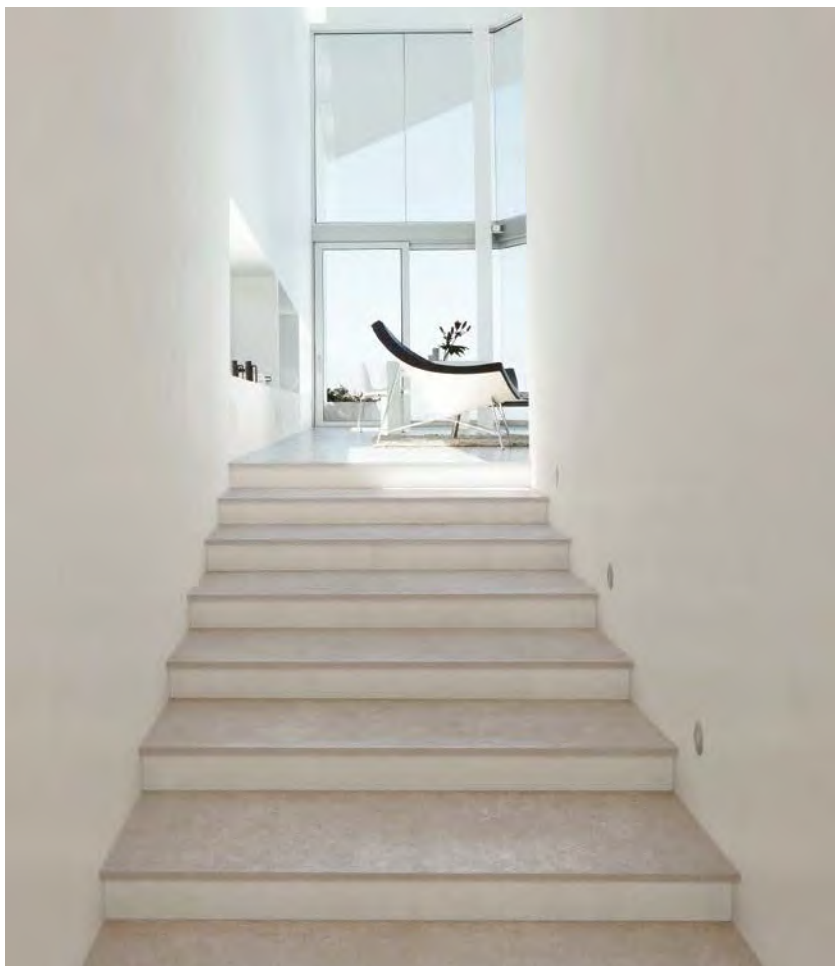

FLOORTECH/1.0

gres fine porcellanato
fine porcelain stoneware
grès cérame fin
feinsteinzeug-kollektionen
gres porcelánico fino
фарфоровый керамогранит





FLOORTECH/1.0

L'importanza delle origini, la forza della materia, la fantasia delle lavorazioni si uniscono alle atmosfere di una cultura millenaria capace di rendersi moderna grazie ad una tecnologia perfetta. **Floortech/1.0** continua il percorso di ricerca che Floorgres da sempre insegue, lontano da stili omologati, in continua sfida e sperimentazione queste 4 pietre sono il simbolo di una scelta forte e personale, capaci di dare vita a progetti intuitivi di colori e superfici per nuove forme abitative.

The importance of origin, the strength of matter and the creativity of processing are all combined with the atmospheres of a thousand-year-old culture, using the perfect technology to become modern. **Floortech/1.0** continues in the same vein of sophistication that Floorgres has always pursued, setting itself apart from standard styles, continuously challenging and experimenting. These 4 stones are the symbol of a strong and personal choice, giving life to intuitive projects with colours and surfaces to create new shapes of living.

L'importance des origines, la force de la matière, l'originalité des traitements épousent l'ambiance d'une culture millénaire capable de devenir moderne grâce à une technologie parfaite. **Floortech/1.0** poursuit le parcours de recherche que Floorgres suit depuis toujours, loin des styles homologués. Symbole d'un choix fort et personnel, ces 4 pierres qui vivent un défi et une expérience permanents, donnent naissance à des projets aux coloris et aux surfaces intuitifs pour de nouvelles formes habitatives.

Die Bedeutung der Ursprünge, die Kraft der Materie und die Fantasie der Bearbeitungen vereinen sich mit den Atmosphären einer tausendjährigen Kultur, die dank einer perfekten Technologie in der Lage ist, modern zu werden. **Floortech/1.0** setzt den Forschungsweg fort, den Floorgres seit jeher verfolgt. Weit ab von vereinheitlichten Stilen, in einer kontinuierlichen Herausforderung und Experimentierung sind diese 4 Steine Symbol einer starken und persönlichen Entscheidung und in der Lage, intuitiven Projekten aus Farben und Oberflächen für neue Wohnformen Leben zu verleihen.

La importancia de los orígenes, la fuerza de la materia, la fantasía de las elaboraciones se unen a las atmósferas de una cultura milenaria capaz de modernizarse gracias a una tecnología perfecta. **Floortech/1.0** sigue el camino de búsqueda que siempre ha perseguido Floorgres, alejado de los estilos homologados, con un constante desafío y experimentación. Estas 4 piedras son el símbolo de una decisión fuerte y personal, capaces de dar vida a proyectos intuitivos de colores y superficies para nuevas formas habitacionales.

Важность первоисточника, сила материала, фантазия обработок, в сочетании с атмосферой многовековой культуры, способной стать современной, благодаря превосходной технологии. **Floortech/1.0** продолжает путь поиска, которому следовала всегда Floorgres; неподвластные стандартным стилям, в постоянной борьбе и экспериментировании, эти 4 камней, способные вдохнуть жизнь в проекты с интуитивными расцветками и поверхностями для создания новых жилых пространств, стали символом сильного и персонального выбора.

FLOORTECH/1.0

FLOOR 1.0

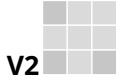
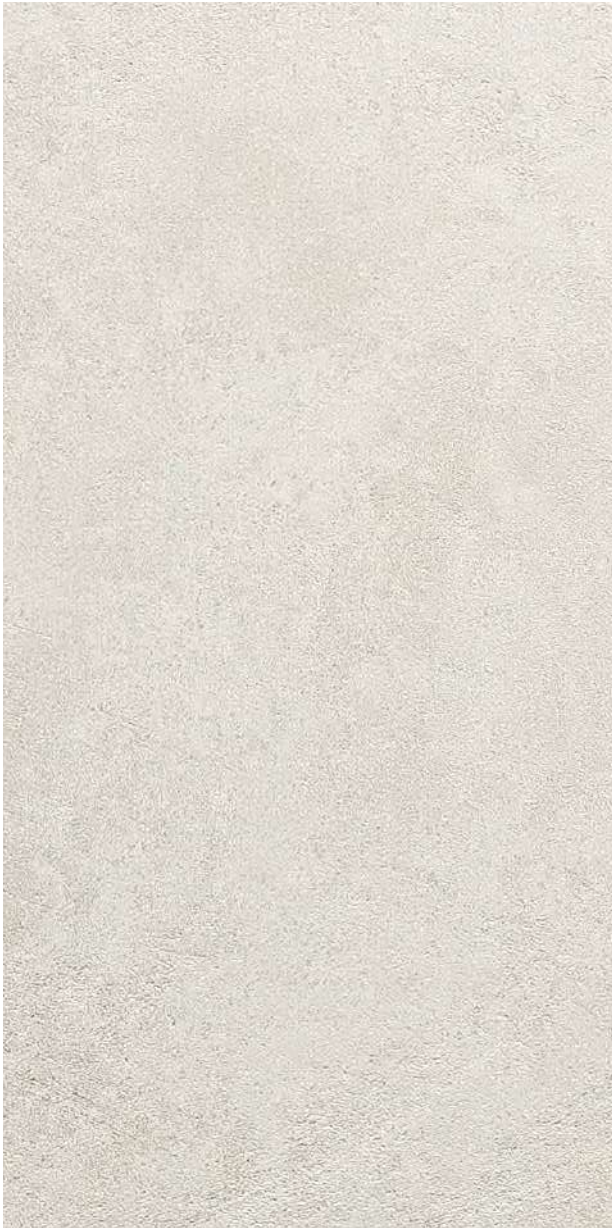

V2

R10
Classe B
(naturale)

R9
(soft)

R11
Classe C
(strutturato)

DCOF>
0,42 Wet
(naturale/
strutturato/
soft)

10 mm 3/8" ↓

GRES FINE PORCELLANATO

FINE PORCELAIN STONEWARE / GRÈS CÉRAME FIN / FEINSTEINZEUG-KOLLEKTIONEN / GRES PORCELÁNICO FINO / фарфоровый керамогранит

SQUADRATO - SQUARED - EQUARRI - REKTIFIZIERT - ESCUADRADO - КАЛИБРОВАННА

10 mm 3/8" ↓		COLOR	SURFACE	60x120 23 ^{5/8"} x47 ^{1/4"}	80x80 31 ^{1/2"} x31 ^{1/2"}	40x80 15 ^{3/4"} x31 ^{1/2"}	20x80 7 ^{7/8"} x31 ^{1/2"}	60x60 23 ^{5/8"} x23 ^{5/8"}	30x60 11 ^{4/8"} x23 ^{5/8"}
FLOORTECH/1.0		FLOOR 1.0	NATURALE	-	-	-	-	739682 ■ FL-06400	-
			STRUTTURATO	738522 ■ FL-09100	-	-	-	738558 ■ FL-06400	738540 ■ FL-05300
			SOFT	738508 ■ FL-09100	738425 ■ FL-08400	738567 ■ FL-06400	738891 ■ FL-09100	738549 ■ FL-06400	738531 ■ FL-05300
			CANNETÈ	-	-	738585 ■ FL-06400	738911 ■ FL-09100	-	-

La superficie CANNETÈ è da utilizzare solo a rivestimento. / The CANNETE' surface is to be used as coating only. / La surface CANNETE' est à utiliser uniquement comme revêtement.
Die glänzende CANNETE' ist nur als Wandfliesen zu verwenden. / La superficie CANNETE' se debe usar sólo con revestimiento. / CANNETE' поверхность должна использоваться только для облицовки.

FLOOR 2.0

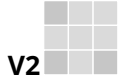

V2

R10
Classe B
(naturale)

R9
(soft)

R11
Classe C
(strutturato)

DCOF>
0,42 Wet
(naturale/
strutturato/
soft)

10 mm 3/8" ↑↓

GRES FINE PORCELLANATO

FINE PORCELAIN STONEWARE / GRÈS CÉRAME FIN / FEINSTEINZEUG-KOLLEKTIONEN / GRES PORCELÁNICO FINO / фарфоровый керамогранит
SQUADRATO - SQUARED - EQUARRI - REKTIFIZIERT - ESCUADRADO - КАЛИБРОВАННА

10 mm 3/8" ↑↓		COLOR	SURFACE	60x120 23 ^{5/8"} x47 ^{1/4"}	80x80 31 ^{1/2"} x31 ^{1/2"}	40x80 15 ^{3/4"} x31 ^{1/2"}	20x80 7 ^{7/8"} x31 ^{1/2"}	60x60 23 ^{5/8"} x23 ^{5/8"}	30x60 11 ^{4/5"} x23 ^{5/8"}
FLOORTECH/1.0		FLOOR 2.0	NATURALE	-	-	-	-	739683 ■ FL-06400	-
			STRUTTURATO	738523 ■ FL-09100	-	-	-	738559 ■ FL-06400	738541 ■ FL-05300
			SOFT	738514 ■ FL-09100	738426 ■ FL-08400	738568 ■ FL-06400	738892 ■ FL-09100	738550 ■ FL-06400	738532 ■ FL-05300
			CANNETÈ	-	-	738586 ■ FL-06400	738912 ■ FL-09100	-	-

FLOORTECH/1.0

FLOOR 3.0

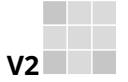

V2

R10
Classe B
(naturale)

R9
(soft)

R11
Classe C
(strutturato)

DCOF>
0,42 Wet
(naturale/
strutturato/
soft)

10 mm 3/8" ↓

GRES FINE PORCELLANATO

FINE PORCELAIN STONEWARE / GRÈS CÉRAME FIN / FEINSTEINZEUG-KOLLEKTIONEN / GRES PORCELÁNICO FINO / фарфоровый керамогранит

SQUADRATO - SQUARED - EQUARRI - REKTIFIZIERT - ESCUADRADO - КАЛИБРОВАННА

10 mm 3/8" ↓		COLOR	SURFACE	60x120 23 ^{5/8"} x47 ^{1/4"}	80x80 31 ^{1/2"} x31 ^{1/2"}	40x80 15 ^{3/4"} x31 ^{1/2"}	20x80 7 ^{7/8"} x31 ^{1/2"}	60x60 23 ^{5/8"} x23 ^{5/8"}	30x60 11 ^{4/8"} x23 ^{5/8"}
FLOORTECH/1.0		FLOOR 3.0	NATURALE	-	-	-	-	739684 ■ FL-06400	-
			STRUTTURATO	738524 ■ FL-09100	-	-	-	738560 ■ FL-06400	738542 ■ FL-05300
			SOFT	738515 ■ FL-09100	738427 ■ FL-08400	738569 ■ FL-06400	738893 ■ FL-09100	738551 ■ FL-06400	738533 ■ FL-05300
			CANNETÈ	-	-	738587 ■ FL-06400	738913 ■ FL-09100	-	-

La superficie CANNETÈ è da utilizzare solo a rivestimento. / The CANNETE' surface is to be used as coating only. / La surface CANNETE' est à utiliser uniquement comme revêtement.
Die glänzende CANNETE' ist nur als Wandfliesen zu verwenden. / La superficie CANNETE' se debe usar sólo con revestimiento. / CANNETE' поверхность должна использоваться только для облицовки.

FLOOR 9.0

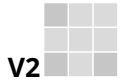

V2

R10
Classe B
(naturale)

R9
(soft)

R11
Classe C
(strutturato)





DCOF>
0,42 Wet
(naturale/
strutturato/
soft)

10 mm 3/8" ↑↓

GRES FINE PORCELLANATO
FINE PORCELAIN STONEWARE / GRÈS CÉRAME FIN / FEINSTEINZEUG-KOLLEKTIONEN / GRES PORCELÁNICO FINO / фарфоровый керамогранит
SQUADRATO - SQUARED - EQUARRI - REKTIFIZIERT - ESCUADRADO - КАЛИБРОВАННА

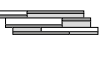

10 mm 3/8" ↑↓	COLOR	SURFACE	60x120 23 ^{5/8} "x47 ^{1/4} "	80x80 31 ^{1/2} "x31 ^{1/2} "	40x80 15 ^{3/4} "x31 ^{1/2} "	20x80 7 ^{7/8} "x31 ^{1/2} "	60x60 23 ^{5/8} "x23 ^{5/8} "	30x60 11 ^{4/8} "x23 ^{5/8} "	
FLOORTECH/1.0		FLOOR 9.0	NATURALE	-	-	-	-	739690 ■ FL-06400	-
			STRUTTURATO	738530 ■ FL-09100	-	-	-	738566 ■ FL-06400	738548 ■ FL-05300
			SOFT	738521 ■ FL-09100	738433 ■ FL-08400	738575 ■ FL-06400	738899 ■ FL-09100	738557 ■ FL-06400	738539 ■ FL-05300
			CANNETÈ	-	-	738593 ■ FL-06400	738919 ■ FL-09100	-	-

FLOORTECH/1.0

10 mm 3/8" ↑↓							
		COLOR	SURFACE				
				30x30 1 1/4" x 1 1/4"	21x40 8 1/4" x 15 3/4"	15x60 6" x 23 5/8"	30x60 1 1/4" x 23 5/8"
				 mosaico tessere 5x5	 modulo listello sfalsato	 modulo listello mix 3D pz/box 6	 modulo listello mix 3D (soft/strutturato) pz/box 4
FLOORTECH/1.0		FLOOR 1.0	SOFT	738967 ■ FL-15100	738985 ■ FL-21000	738976 ▲ FL-03600	739392 ▲ FL-07300
		FLOOR 2.0	SOFT	738968 ■ FL-15100	738986 ■ FL-21000	738977 ▲ FL-03600	739393 ▲ FL-07300
		FLOOR 3.0	SOFT	738969 ■ FL-15100	738987 ■ FL-21000	738978 ▲ FL-03600	739394 ▲ FL-07300
		FLOOR 9.0	SOFT	738975 ■ FL-15100	738993 ■ FL-21000	738984 ▲ FL-03600	739400 ▲ FL-07300

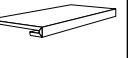
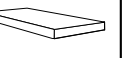
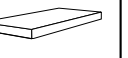
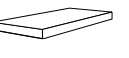
PEZZI SPECIALI/SPECIAL TRIMS/PIÈCES SPÉCIALES/FORMSTÜCKE/PIEZAS ESPECIALES/Специальные изделия

10 mm 3/8" ↑↓								
		COLOR	SURFACE					
				4,6x60 1 4/5" x 23 5/8"	33x120x3 13" x 47 1/4" x 1 1/8"	33x120x3 13" x 47 1/4" x 1 1/8"	33x120x3 13" x 47 1/4" x 1 1/8"	33x120x3 13" x 47 1/4" x 1 1/8"
				 battiscopa	 gradino pz/box 2	 angolo gradino dx pz/box 2	 angolo gradino sx pz/box 2	 angolo gradino dx/sx pz/box 1
FLOORTECH/1.0		FLOOR 1.0	SOFT	745511 ◆ FL-01600	739049 ▲ FL-20400	739058 ▲ FL-31100	739067 ▲ FL-31100	739374 ▲ FL-45000
			STRUTTURATO	-	739076 ▲ FL-20400	739085 ▲ FL-31100	739094 ▲ FL-31100	739383 ▲ FL-45000
		FLOOR 2.0	SOFT	745512 ◆ FL-01600	739050 ▲ FL-20400	739059 ▲ FL-31100	739068 ▲ FL-31100	739375 ▲ FL-45000
			STRUTTURATO	-	739077 ▲ FL-20400	739086 ▲ FL-31100	739095 ▲ FL-31100	739384 ▲ FL-45000
		FLOOR 3.0	SOFT	745513 ◆ FL-01600	739051 ▲ FL-20400	739060 ▲ FL-31100	739069 ▲ FL-31100	739376 ▲ FL-45000
			STRUTTURATO	-	739078 ▲ FL-20400	739087 ▲ FL-31100	739096 ▲ FL-31100	739385 ▲ FL-45000
		FLOOR 9.0	SOFT	745519 ◆ FL-01600	739057 ▲ FL-20400	739066 ▲ FL-31100	739075 ▲ FL-31100	739382 ▲ FL-45000
			STRUTTURATO	-	739084 ▲ FL-20400	739093 ▲ FL-31100	739102 ▲ FL-31100	739391 ▲ FL-45000

10 mm 3/8" ↑↓					
		COLOR	SURFACE		
				1,2x20 1/2" x 7 7/8"	1,2x20 1/2" x 7 7/8"
				 quarter round pz/box 12	 angolo quarter round pz/box 4
FLOORTECH/1.0		FLOOR 1.0	SOFT	739112 ▲ FL-01160	739121 ▲ FL-01800
		FLOOR 2.0	SOFT	739113 ▲ FL-01160	739122 ▲ FL-01800
		FLOOR 3.0	SOFT	739114 ▲ FL-01160	739123 ▲ FL-01800
		FLOOR 9.0	SOFT	739120 ▲ FL-01160	739129 ▲ FL-01800

Architectural design

10 mm 3/8" ↑↓

COLOR

SURFACE

60x60
23^{5/8"}x23^{5/8"}



DECOR
FLOOR 1.0

SOFT

738680
■ FL-06700



DECOR
FLOOR 2.0

SOFT

738681
■ FL-06700

FLOORTECH/1.0



DECOR
FLOOR 3.0

SOFT

738682
■ FL-06700



DECOR
FLOOR 9.0

SOFT

738688
■ FL-06700

FLOORTECH/1.0	scatola - box			pallet		
	pz	m ²	kg	box	m ²	kg
60x120	2	1,44	33,00	30	43,20	1030
80x80	2	1,28	30,00	40	51,20	1220
40x80	3	0,96	22,00	56	53,76	1260
20x80	6	0,96	21,00	48	46,08	1050
60x60	3	1,08	25,00	40	43,20	1040
30x60	6	1,08	24,00	40	43,20	990
60x60 decor soft	3	1,08	25,00	40	43,20	1040
21x40 mod. list. sfalsato	5	0,42	10,00	40	16,80	410

FLOORTECH/1.0	scatola - box			pallet		
	pz	m ²	kg	box	m ²	kg
4,6x60 battiscopa	14	8,40	8,40	-	-	-

Per un effetto ottimale della posa, florim suggerisce di mantenere 2 mm di fuga per pose monoformato e 3 mm per combinare formati misti - For optimal installation results, florim recommends maintaining a joint of 2 mm 1/12" for single format installations and 3 mm 1/8" to combine mixed formats. - Pour réaliser une pose parfaite, florim suggère de maintenir 2 mm de joint pour la pose des monoformats, et 3 mm pour les combinaisons de formats mixtes. - Um einen optimalen effekt beim verlegen zu erzielen empfiehlt florim eine 2 mm fugе bei einformatigen verlegungen und 3 mm fugе bei formatkombinationen Para lograr los máximos resultados en la posa del producto, florim aconseja 2 mm de junta en aplicaciones monoformato y 3 mm en combinaciones de formatos mixtos - **ДЛЯ ОПТИМАЛЬНОЙ УКЛАДКИ " FLORIM" РЕКОМЕНДУЕТ ВЫДЕРЖИВАТЬ ЗАЗОР 2 ММ ДЛЯ МОНОФОРМАТА И 3 ММ ПРИ СМЕШАННЫХ ФОРМАТАХ.**



FLOWTECH

gres fine porcellanato
fine porcelain stoneware
grès cérame fin
feinsteinzeug-kollektionen
gres porcelánico fino
фарфоровый керамогранит



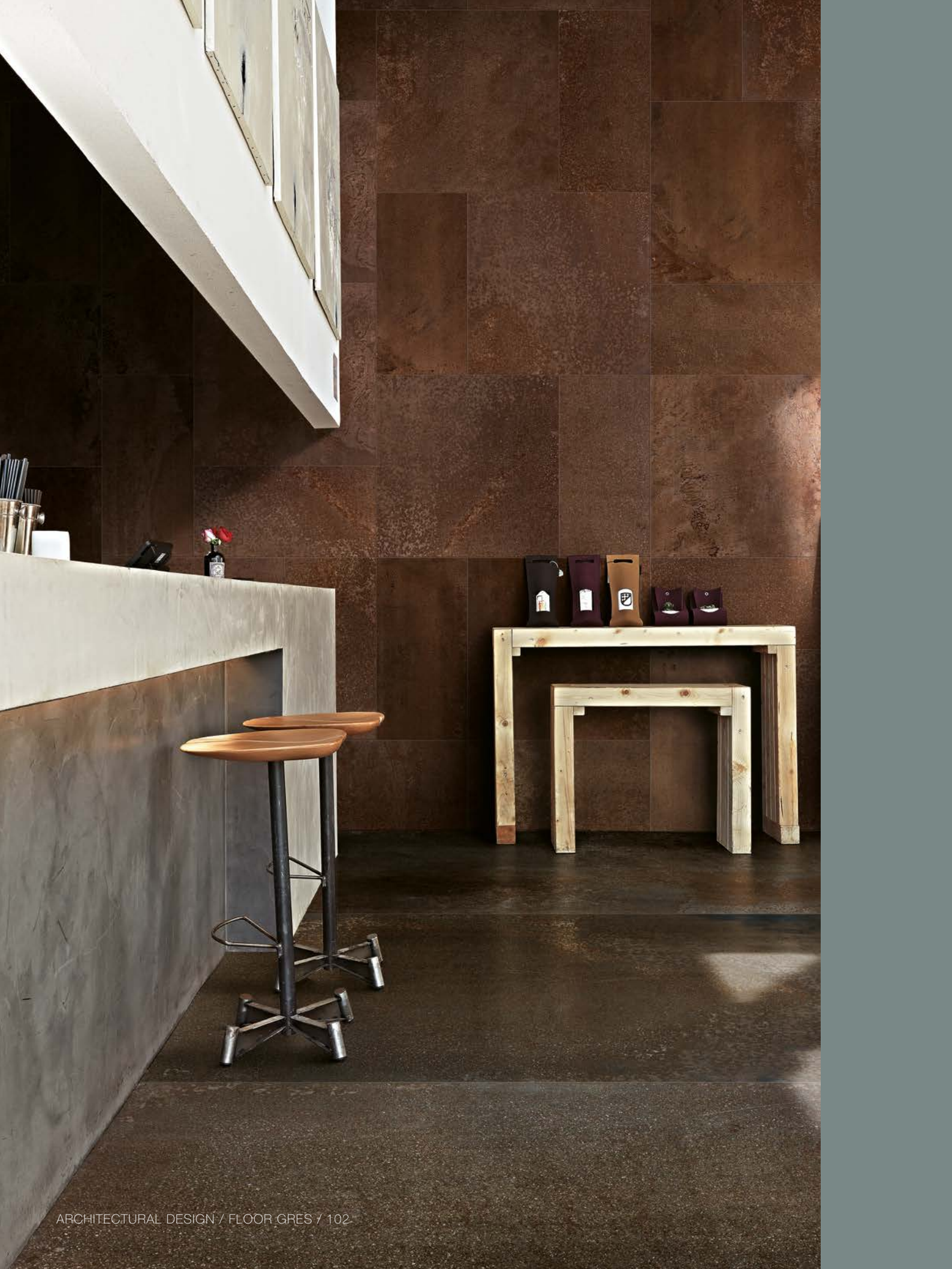

FLOWTECH

Le lastre **Flowtech** permettono di arricchire ambienti pubblici e privati con il deciso fascino industriale delle lamiere metalliche. L'estetica coglie tutti i tratti iconici del materiale: è curata anche nei piccoli particolari e perfettamente bilanciata. A questo si aggiunge il vantaggio di un aspetto totalmente stabile nel tempo, e di una materia che non risente dell'umidità, dell'usura o di agenti atmosferici. Le tre varianti colore insieme all'assortimento di formati, dalle grandi lastre ai pratici sottoformati in varie misure, agevolano la posa in opera e la versatilità architettonica della collezione.

Flowtech panels enrich public and private spaces with the industrial charm of metallic sheeting. The aesthetic expresses all the iconic features of the material, even down to the smallest details, in perfect equilibrium. They also have the benefit of being unchanged by the passage of time, in a material which is immune to the effects of humidity, wear and atmospheric agents. The three colour variants, combined with a variety of sizes, from large panels to a number of handy smaller formats, make them easy to install and adapt to any setting.

Les dalles **Flowtech** confèrent aux espaces publics et privés le charme typiquement industriel des tôles métalliques. Leur esthétique, qui met en évidence toutes les caractéristiques du matériau, est soignée dans les moindres détails et parfaitement équilibrée. À cela s'ajoute l'avantage d'un aspect extrêmement durable et d'une matière résistante à l'humidité, à l'usure et aux agents atmosphériques. Les trois variantes de couleurs et l'assortiment de formats disponibles, des grandes dalles aux sous-formats pratiques proposés en plusieurs dimensions, facilitent la pose et permettent son application dans différents contextes architecturaux.

Die Platten von **Flowtech** machen es möglich öffentliche und private Bereiche um den deutlichen industriellen Reiz der Metallbleche zu bereichern. Die Ästhetik birgt alle ikonischen Züge des Materials: es ist auch in den kleinsten Einzelheiten gepflegt und perfekt ausgewogen. Hinzu kommen die Vorteile eines auf die Dauer absolut beständigen Aussehens und eines Materials, dem Feuchtigkeit, Verschleiß oder Umwelteinflüsse nicht schaden können. Die drei Farbvarianten, zusammen mit dem Sortiment an Formaten, von den großen Platten bis zu den praktischen Unterformaten in verschiedenen Größen, erleichtern die Verlegung an Ort und Stelle und die architektonische Vielseitigkeit der Kollektion.

Las losas **Flowtech** permiten enriquecer ambientes públicos y privados con el intenso encanto industrial de las chapas metálicas. La estética abarca todos los rasgos icónicos del material: está cuidada incluso en los pequeños detalles y perfectamente equilibrada. A esto se añade la ventaja de un aspecto totalmente estable en el tiempo y de una materia que no se resiente a la humedad, al desgaste o a los agentes atmosféricos. Las tres variantes de color junto al surtido de formatos, desde las grandes losas hasta los prácticos subformatos en varias medidas, facilitan la colocación en la obra y la versatilidad arquitectónica de la colección.

Плиты **Flowtech** позволяют наделять общественные и частные интерьеры решительным промышленным очарованием листового металла. Эстетика запечатлела все характерные черты этого материала: она проработана в мельчайших деталях и великолепно уравновешена. К этому прибавляется преимущество неизменяющегося с течением времени внешнего вида и материала, на который не влияет влага, износ или атмосферное воздействие. Три варианта цвета наряду с ассортиментом форматов - от больших плит до практических мелких форматов разнообразных размеров, облегчают укладку и повышают архитектурную универсальность коллекции.

RUSSET



AGED BRONZE

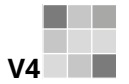

V4

R9

DCOF>
0,42 Wet

10 mm 3/8" ↑↓

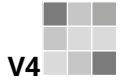

V4

R9

(naturale/
matte)

R10
Classe B
(R+PTV)

DCOF>
0,42 Wet

PTV
>36 wet
slider 4S
(R+PTV)





6 mm 1/4" ↑↓

FLORM OVERSIZE
magnum

GRES FINE PORCELLANATO

FINE PORCELAIN STONEWARE / GRÈS CÉRAME FIN / FEINSTEINZEUG-KOLLEKTIONEN / GRES PORCELÁNICO FINO / фарфоровый керамогранит

SQUADRATO - SQUARED - EQUARRI - REKTIFIZIERT - ESCUADRADO - КАЛИБРОВАННА

				10 mm 3/8" ↑↓				6 mm 1/4" ↑↓	
		COLOR	SURFACE	60x120 23 ^{5/8"} x47 ^{1/4"}	80x80 31 ^{1/2"} x31 ^{1/2"}	40x80 15 ^{3/4"} x31 ^{1/2"}	60x60 23 ^{5/8"} x23 ^{5/8"}	30x60 11 ^{4/5"} x23 ^{5/8"}	
FLOWTECH		RUSSET	NATURALE	757070 ■ FL-09100	757064 ■ FL-08400	757067 ■ FL-06400	757073 ■ FL-06400	757076 ■ FL-04600	
		AGED BRONZE	NATURALE	757071 ■ FL-09100	757065 ■ FL-08400	757068 ■ FL-06400	757074 ■ FL-06400	757077 ■ FL-04600	
FLOWTECH		RUSSET	NATURALE	757908 ■ FL-14500	757911 ■ FL-11900	756645 ■ FL-09900	757061 ■ FL-08400	757058 ■ FL-07700	
			R+PTV	-	-	758807 ■ FL-09900	757914 ■ FL-08400	-	
		AGED BRONZE	NATURALE	757909 ■ FL-14500	757912 ■ FL-11900	756646 ■ FL-09900	757062 ■ FL-08400	757059 ■ FL-07700	
			R+PTV	-	-	758808 ■ FL-09900	757915 ■ FL-08400	-	

BURNISHED

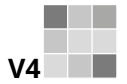

V4

R9

DCOF>
0,42 Wet

10 mm 3/8" ↑ ↓

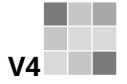

V4

R9

(naturale/
matte)

R10
Classe B
(R+PTV)

DCOF>
0,42 Wet

PTV
>36 wet
slider 4S
(R+PTV)

6 mm 1/4" ↑ ↓

FLOORM OVERSIZE
magnum

GRES FINE PORCELLANATO

FINE PORCELAIN STONEWARE / GRÈS CÉRAME FIN / FEINSTEINZEUG-KOLLEKTIONEN / GRES PORCELÁNICO FINO / фарфоровый керамогранит

SQUADRATO - SQUARED - EQUARRI - REKTIFIZIERT - ESCUADRADO - КАЛИБРОВАННА







10 mm 3/8" ↑ ↓	COLOR	SURFACE	60x120 23 ^{5/8"} x47 ^{1/4"}	80x80 31 ^{1/2"} x31 ^{1/2"}	40x80 15 ^{3/4"} x31 ^{1/2"}	60x60 23 ^{5/8"} x23 ^{5/8"}	30x60 11 ^{4/5"} x23 ^{5/8"}	
FLOWTECH		BURNISHED	NATURALE	757072 ■ FL-09100	757066 ■ FL-08400	757069 ■ FL-06400	757075 ■ FL-06400	757078 ■ FL-04600

6 mm 1/4" ↑ ↓	COLOR	SURFACE	160x320 63"x126"	160x160 63"x63"	120x240 47 ^{1/4"} x94 ^{1/2"}	120x120 47 ^{1/4"} x47 ^{1/4"}	60x120 23 ^{5/8"} x47 ^{1/4"}	
FLOWTECH		BURNISHED	NATURALE	757910 ■ FL-14500	757913 ■ FL-11900	756647 ■ FL-09900	757063 ■ FL-08400	757060 ■ FL-07700
			R+PTV	-	-	758809 ■ FL-09900	757916 ■ FL-08400	-

FLOWTECH

10 mm 3/8" ↑↓		COLOR	SURFACE	21x40 $8\frac{1}{4}'' \times 15\frac{3}{4}''$  modulo listello sfalsato pz/box 5
FLOWTECH		RUSSET	NATURALE	756615 ▲ FL-01600
		AGED BRONZE	NATURALE	756616 ▲ FL-01600
		BURNISHED	NATURALE	756617 ▲ FL-01600

PEZZI SPECIALI/SPECIAL TRIMS/PIÈCES SPÉCIALES/FORMSTÜCKE/PIEZAS ESPECIALES/Специальные изделия

10 mm 3/8" ↑↓		COLOR	SURFACE	4,6x80 $1\frac{4}{5}'' \times 31\frac{1}{2}''$  battiscopa	33x120x3 $13'' \times 47\frac{1}{4}'' \times 1\frac{1}{8}''$  gradino pz/box 2	33x120x3 $13'' \times 47\frac{1}{4}'' \times 1\frac{1}{8}''$  angolo gradino dx pz/box 2	33x120x3 $13'' \times 47\frac{1}{4}'' \times 1\frac{1}{8}''$  angolo gradino sx pz/box 2
FLOWTECH		RUSSET	NATURALE	756618 ◆ FL-01600	758216 ▲ FL-20400	758219 ▲ FL-31100	758222 ▲ FL-31100
		AGED BRONZE	NATURALE	756619 ◆ FL-01600	758217 ▲ FL-20400	758220 ▲ FL-31100	758223 ▲ FL-31100
		BURNISHED	NATURALE	756620 ◆ FL-01600	758218 ▲ FL-20400	758221 ▲ FL-31100	758224 ▲ FL-31100







FLOWTECH	scatola - box			pallet		
	pz	mq	kg	box	mq	kg
60x120	2	1,44	32,00	30	43,20	990
80x80	2	1,28	30,00	40	51,20	1220
40x80	3	0,96	22,00	28	26,88	640
60x60	3	1,08	24,00	40	43,20	990
30x60	6	1,08	24,00	40	43,20	990

FLOWTECH	scatola - box			pallet		
	pz	ml	kg	box	mq	kg
4,6x80 battiscopa	12	9,60	9,60	-	-	-

Architectural design

PEZZI SPECIALI/SPECIAL TRIMS
PIÈCES SPÉCIALES/FORMSTÜCKE
PIEZAS ESPECIALES/Специальные изделия

6 mm 1/4" ↑↓

	COLOR	SURFACE	30x30 11 4/5" x 11 4/5"  mosaico tessere 7,5x7,5 pz/box 11	30x30 11 4/5" x 11 4/5"  muretto tessere 7,5x15 pz/box 11	30x30 11 4/5" x 11 4/5"  mosaico tessere 1,5x3 pz/box 11	4,6x60 1 4/5" x 23 5/8"  battiscopa
FLOWTECH	 RUSSET	NATURALE	756624 ▲ FL-01800	756621 ▲ FL-01800	756627 ▲ FL-02700	756630 ◆ FL-01800
	 AGED BRONZE	NATURALE	756625 ▲ FL-01800	756622 ▲ FL-01800	756628 ▲ FL-02700	756631 ◆ FL-01800
	 BURNISHED	NATURALE	756626 ▲ FL-01800	756623 ▲ FL-01800	756629 ▲ FL-02700	756632 ◆ FL-01800

FLORM OVERSIZE
magnUm

160x320/120x280/120x240/120x120/60x120

Specifica Imballo pag.
Packaging specifications on page
Spécifications d'emballage à page
Verpackungsdetail Seite
Especificaciones de embalaje a la página
Информация об упаковке на стр.
176/177

Per un effetto ottimale della posa, florim suggerisce di mantenere 2 mm di fuga per pose monofornato e 3 mm per combinare formati misti - For optimal installation results, florim recommends maintaining a joint of 2 mm 1/12" for single format installations and 3 mm 1/8" to combine mixed formats. - Pour réaliser une pose parfaite, florim suggère de maintenir 2 mm de joint pour la pose des monofornats, et 3 mm pour les combinaisons de formats mixtes. - Um einen optimalen effekt beim verlegen zu erzielen empfiehlt florim eine 2 mm fuge bei einformatigen verlegungen und 3 mm fuge bei formatkombinationen Para lograr los máximos resultados en la posa del producto, florim aconseja 2 mm de junta en aplicaciones monofornato y 3 mm en combinaciones de formatos mixtos - **ДЛЯ ОПТИМАЛЬНОЙ УКЛАДКИ " FLORIM" РЕКОМЕНДУЕТ ВЫДЕРЖИВАТЬ ЗАЗОР 2 ММ ДЛЯ МОНОФОРМАТА И 3 ММ ПРИ СМЕШАННЫХ ФОРМАТАХ.**

In relazione alle differenti tecnologie produttive l'accostamento di prodotti con spessori diversi potrebbe presentare delle disomogeneità, se ne sconsiglia pertanto l'abbinamento. / Due to the different production technologies, contiguous installation of products with different thickness may give a non-homogeneous result. For this reason we do not recommend this option. / Vu que différentes technologies de production sont utilisées avec des épaisseurs différentes, des problèmes d'homogénéité pourraient se présenter, il est donc déconseillé de les poser ensemble. / Wegen unterschiedlicher Produktionstechnologien können die Fliesen mit verschiedenen Materialstärken optische Differenzen aufweisen. Von einem direkten Aneinanderlegen wird deshalb abgeraten. / Dadas las diferentes tecnologías productivas, la combinación de productos de diferentes espesores podría dar lugar a heterogeneidad, por lo que se desaconseja mezclarlas. / **В связи с различием в технологиях производства, сочетание продукции разной толщины иногда может представлять неоднородность материала. Такие сочетания следует избегать.**

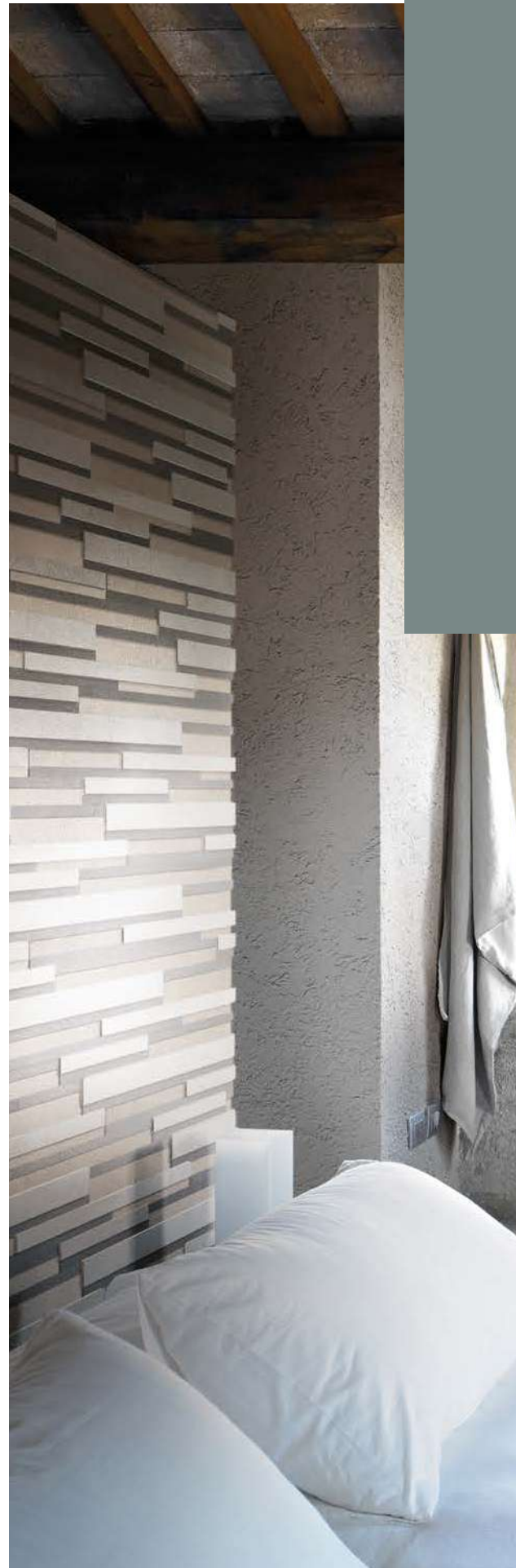

INDUSTRIAL

gres fine porcellanato
fine porcelain stoneware
grès cérame fin
feinsteinzeug-kollektionen
gres porcelánico fino
фарфоровый керамогранит





INDUSTRIAL

Modernità e semplicità caratterizzano questa superficie neutra e lineare che si esprime attraverso un mix di colori, formati e decori. **Industrial** si propone nella sua forma pura, per essere utilizzata in modo trasversale, efficace e accattivante in ogni progetto di architettura.

This neutral and linear surface is distinguished for being modern and simple, expressing itself through a mix of colours, sizes and decorations. **Industrial** presents itself in its purest form, to be used across the board, efficiently and captivatingly, in every architectural project.

Modernité et simplicité caractérisent cette surface neutre et linéaire qui s'exprime dans un mélange de coloris, de formats et de décors. Efficace et captivante dans tous les projets d'architecture, **Industrial** se propose dans sa forme pure pour être utilisée de façon transversale.

Modernität und Einfachheit kennzeichnen diese neutrale und lineare Oberfläche, die sich durch einen Mix aus Farben, Formaten und Dekoren ausdrückt. **Industrial** bietet sich in seiner puren Form an, um übergreifend, effizient und ansprechend in jedem Architekturprojekt verwendet werden zu können.

Esta superficie neutra y lineal, que se expresa a través de una mezcla de colores, formatos y decoraciones, se caracteriza por su gran modernidad y simplicidad. **Industrial** se propone en su forma pura, para ser usada transversalmente, eficaz y fascinante en cualquier proyecto de arquitectura.

Современность и простота являются характерными чертами этой нейтральной и линейной поверхности, которая находит своё выражение в смешении цветов, форматов и декоративных отделок. **Industrial** предлагает себя в чистой форме, для использования во взаимопересекающихся решениях, будучи эффективным и приятным в любом из архитектурных проектов.

INDUSTRIAL

IVORY



TAUPE



V2

R10
Classe B
(naturale)

R9
Classe A
(soft)

R11
Classe C
(bocciardato)

DCOF>
0,42 Wet

10 mm 3/8" ↑↓



V2

R9
(matte)

R10
Classe B
(R+PTV)

DCOF>
0,42 Wet

PTV>36 wet
slider 4S
(R+PTV)

6 mm 1/4" ↑↓

FLORIM OVERSIZE
magnUlm

GRES FINE PORCELLANATO

FINE PORCELAIN STONEWARE / GRÈS CÉRAMÉ FIN / FEINSTEINZEUG-KOLLEKTIONEN / GRES PORCELÁNICO FINO / фарфоровый керамогранит

SQUADRATO - SQUARED - EQUARRI - REKTIFIZIERT - ESCUADRADO - КАЛИБРОВАННА

10 mm 3/8" ↑↓		COLOR	SURFACE	60x120 23 ^{5/8} "x47 ^{1/4} "	80x80 31 ^{1/2} "x31 ^{1/2} "	60x60 23 ^{5/8} "x23 ^{5/8} "	30x60 11 ^{4/5} "x23 ^{5/8} "	40x80 15 ^{3/4} "x31 ^{1/2} "	20x80 7 ^{7/8} "x31 ^{1/2} "	
INDUSTRIAL	IVORY	NATURALE		738816 ■ FL-09100	738656 ■ FL-08100	738803 ■ FL-05800	738791 ■ FL-04900	738828 ■ FL-05800	738931 ■ FL-08400	
		SOFT		738822 ■ FL-09700	738662 ■ FL-08400	738810 ■ FL-06400	738797 ■ FL-05500	738834 ■ FL-06400	738937 ■ FL-09100	
		BOCCIARDATO		-	-	-	738955 ■ FL-05500	-	-	
	TAUPE	NATURALE		738819 ■ FL-09100	738659 ■ FL-08100	738807 ■ FL-05800	738794 ■ FL-04900	738831 ■ FL-05800	738934 ■ FL-08400	
		SOFT		738825 ■ FL-09700	738665 ■ FL-08400	738813 ■ FL-06400	738800 ■ FL-05500	738837 ■ FL-06400	738940 ■ FL-09100	
		BOCCIARDATO		-	-	-	738958 ■ FL-05500	-	-	
6 mm 1/4" ↑↓		COLOR	SURFACE	160x320 63"x126"	160x160 63"x63"	120x280 47 ^{1/4} "x110 ^{1/4} "	120x240 47 ^{1/4} "x94 ^{1/2} "	120x120 47 ^{1/4} "x47 ^{1/4} "	80x80 31 ^{1/2} "x31 ^{1/2} "	60x120 23 ^{5/8} "x47 ^{1/4} "
INDUSTRIAL	IVORY	NATURALE		744351 ■ FL-14500	744393 ■ FL-11900	757774 ■ FL-10800	744399 ■ FL-09900	744405 ■ FL-08400	744381 ■ FL-07000	744411 ■ FL-07700
		R+PTV		-	-	-	758799 ■ FL-09900	757780 ■ FL-08400	-	-
	TAUPE	NATURALE		744352 ■ FL-14500	744394 ■ FL-11900	757775 ■ FL-10800	744400 ■ FL-09900	744406 ■ FL-08400	744382 ■ FL-07000	744412 ■ FL-07700
		R+PTV		-	-	-	758800 ■ FL-09900	757781 ■ FL-08400	-	-

MOKA



SAGE

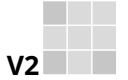

V2

R10
Classe B
(naturale)

R9
Classe A
(soft)

R11
Classe C
(bocciardato)

DCOF>
0,42 Wet

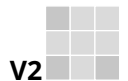

V2

R9
(matte)

R10
Classe B
(R+PTV)

DCOF>
0,42 Wet

PTV>36 wet
slider 4S
(R+PTV)



6 mm 1/4" ↑↓
FLORIM OVERSIZE
magnum

GRES FINE PORCELLANATO

FINE PORCELAIN STONEWARE / GRÈS CÉRAME FIN / FEINSTEINZEUG-KOLLEKTIONEN / GRES PORCELÁNICO FINO / фарфоровый керамогранит

SQUADRATO - SQUARED - EQUARRI - REKTIFIZIERT - ESCUADRADO - КАЛИБРОВАННА

10 mm 3/8" ↑↓		COLOR	SURFACE	60x120 23 ^{5/8} "x47 ^{1/4} "	80x80 31 ^{1/2} "x31 ^{1/2} "	60x60 23 ^{5/8} "x23 ^{5/8} "	30x60 11 ^{4/5} "x23 ^{5/8} "	40x80 15 ^{3/4} "x31 ^{1/2} "	20x80 7 ^{7/8} "x31 ^{1/2} "	
INDUSTRIAL	MOKA	NATURALE		738820 ■ FL-09100	738660 ■ FL-08100	738808 ■ FL-05800	738795 ■ FL-04900	738832 ■ FL-05800	738935 ■ FL-08400	
		SOFT		738826 ■ FL-09700	738666 ■ FL-08400	738814 ■ FL-06400	738801 ■ FL-05500	738838 ■ FL-06400	738941 ■ FL-09100	
		BOCCIARDATO		-	-	-	738959 ■ FL-05500	-	-	
	SAGE	NATURALE		738817 ■ FL-09100	738657 ■ FL-08100	738804 ■ FL-05800	738792 ■ FL-04900	738829 ■ FL-05800	738932 ■ FL-08400	
		SOFT		738823 ■ FL-09700	738663 ■ FL-08400	738811 ■ FL-06400	738798 ■ FL-05500	738835 ■ FL-06400	738938 ■ FL-09100	
		BOCCIARDATO		-	-	-	738956 ■ FL-05500	-	-	
6 mm 1/4" ↑↓		COLOR	SURFACE	160x320 63"x126"	160x160 63"x63"	120x280 47 ^{1/4} "x110 ^{1/4} "	120x240 47 ^{1/4} "x94 ^{1/2} "	120x120 47 ^{1/4} "x47 ^{1/4} "	80x80 31 ^{1/2} "x31 ^{1/2} "	60x120 23 ^{5/8} "x47 ^{1/4} "
INDUSTRIAL	MOKA	NATURALE		744354 ■ FL-14500	744396 ■ FL-11900	757776 ■ FL-10800	744402 ■ FL-09900	744408 ■ FL-08400	744384 ■ FL-07000	744414 ■ FL-07700
		R+PTV		-	-	-	758801 ■ FL-09900	757782 ■ FL-08400	-	-
	SAGE	NATURALE		744353 ■ FL-14500	744395 ■ FL-11900	757777 ■ FL-10800	744401 ■ FL-09900	744407 ■ FL-08400	744383 ■ FL-07000	744413 ■ FL-07700
		R+PTV		-	-	-	758802 ■ FL-09900	757783 ■ FL-08400	-	-

INDUSTRIAL

STEEL

PLOMB



V2

R10
Classe B
(naturale)

R9
Classe A
(soft)

R11
Classe C
(bocciardato)

DCOF>
0,42 Wet

10 mm 3/8" ↑↓



V2

R9
(matte)

R10
Classe B
(R+PTV)

DCOF>
0,42 Wet

PTV>36 wet
slider 4S
(R+PTV)

6 mm 1/4" ↑↓

FLORIM OVERSIZE
magnum







GRES FINE PORCELLANATO

FINE PORCELAIN STONEWARE / GRÈS CÉRAME FIN / FEINSTEINZEUG-KOLLEKTIONEN / GRES PORCELÁNICO FINO / фарфоровый керамогранит

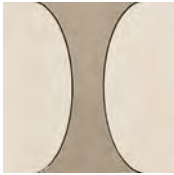
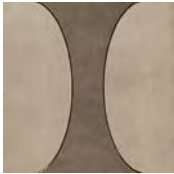
SQUADRATO - SQUARED - EQUARRI - REKTIFIZIERT - ESCUADRADO - КАЛИБРОВАННА

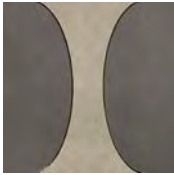
10 mm 3/8" ↑↓		COLOR	SURFACE	60x120 23 ^{5/8"} x47 ^{1/4"}	80x80 31 ^{1/2"} x31 ^{1/2"}	60x60 23 ^{5/8"} x23 ^{5/8"}	30x60 11 ^{4/5"} x23 ^{5/8"}	40x80 15 ^{3/4"} x31 ^{1/2"}	20x80 7 ^{7/8"} x31 ^{1/2"}	
INDUSTRIAL	STEEL	NATURALE		738818 ■ FL-09100	738658 ■ FL-08100	738806 ■ FL-05800	738793 ■ FL-04900	738830 ■ FL-05800	738933 ■ FL-08400	
		SOFT		738824 ■ FL-09700	738664 ■ FL-08400	738812 ■ FL-06400	738799 ■ FL-05500	738836 ■ FL-06400	738939 ■ FL-09100	
		BOCCIARDATO		-	-	-	738957 ■ FL-05500	-	-	
	PLOMB	NATURALE		738821 ■ FL-09100	738661 ■ FL-08100	738809 ■ FL-05800	738796 ■ FL-04900	738833 ■ FL-05800	738936 ■ FL-08400	
		SOFT		738827 ■ FL-09700	738667 ■ FL-08400	738815 ■ FL-06400	738802 ■ FL-05500	738839 ■ FL-06400	738942 ■ FL-09100	
		BOCCIARDATO		-	-	-	738960 ■ FL-05500	-	-	
6 mm 1/4" ↑↓		COLOR	SURFACE	160x320 63"x126"	160x160 63"x63"	120x280 47 ^{1/4"} x110 ^{1/4"}	120x240 47 ^{1/4"} x94 ^{1/2"}	120x120 47 ^{1/4"} x47 ^{1/4"}	80x80 31 ^{1/2"} x31 ^{1/2"}	60x120 23 ^{5/8"} x47 ^{1/4"}
INDUSTRIAL	STEEL	NATURALE		744350 ■ FL-14500	744392 ■ FL-11900	757778 ■ FL-10800	744398 ■ FL-09900	744404 ■ FL-08400	744380 ■ FL-07000	744410 ■ FL-07700
		R+PTV		-	-	-	758803 ■ FL-09900	757784 ■ FL-08400	-	-
	PLOMB	NATURALE		744355 ■ FL-14500	744397 ■ FL-11900	757779 ■ FL-10800	744403 ■ FL-09900	744409 ■ FL-08400	744385 ■ FL-07000	744415 ■ FL-07700
		R+PTV		-	-	-	758804 ■ FL-09900	757785 ■ FL-08400	-	-

10 mm 3/8" ↑↓

	COLOR	SURFACE	30x30 11 4/5" x 11 4/5" pz/box 4
	DECORO A TAUPE / IVORY	SOFT	739434 ▲ FL-03800
	DECORO A MOKA / TAUPE	SOFT	739436 ▲ FL-03800
	DECORO A PLOMB / STEEL	SOFT	739437 ▲ FL-03800
	DECORO A SAGE / PLOMB	SOFT	739435 ▲ FL-03800
INDUSTRIAL		DECORO B TAUPE / IVORY	739438 ▲ FL-03800
		DECORO B MOKA / TAUPE	739440 ▲ FL-03800
		DECORO B PLOMB / STEEL	739441 ▲ FL-03800
		DECORO B SAGE / PLOMB	739439 ▲ FL-03800

INDUSTRIAL

PUZZLE DECOR

La fuga diventa decoro, la separazione della materia acquista una nuova espressività grazie alla tecnologia dell'idrogetto. Ogni realizzazione può essere unica e personalizzata in base allo spazio in cui dovrà essere inserita, il decoro può essere adattato a qualsiasi misura richiesta. Fuga tra i pezzi 1 mm. Per la realizzazione del progetto serve la pianta del cliente con indicazione precisa delle misure delle pareti da rivestire. Nel caso in cui non ci siano pareti perfettamente in squadra i pezzi ai lati saranno lasciati più lunghi di 5 cm.

Joint spaces become part of the decoration. The space that separates the material acquires a new level of expression thanks to water-jet technology. Each project can be unique and customised based on the area where it will be installed. The decoration can be adapted to any requested measurements. 1 mm joint space between tiles. The customer's floor plan is required to design the project, providing the precise measurements of the walls where the material will be applied. If the walls are not perfectly square, the side pieces must be left 5 cm longer.

Le joint devient une décoration, la séparation de la matière acquiert une nouvelle expressivité grâce à la technologie de l'hydrojet. Toutes les réalisations peuvent être uniques et personnalisées selon l'espace où elles devront être insérées, la décoration peut être adaptée à toute mesure demandée. Joint entre les pièces 1 mm. Pour la réalisation du projet, il faut le plan du client avec l'indication précise des mesures des murs à couvrir. Au cas où les murs ne seraient pas parfaitement en équerre, les pièces sur les côtés seront laissées plus longues de 5 cm.

Die Fuge wird zum Dekor; die Trennung der Materie erlangt dank der Wasserstrahltechnologie eine neue Ausdruckskraft. Jede Umsetzung kann einzigartig sein und je nach Raum, in den sie eingefügt werden soll, personalisiert werden. Das Dekor kann jeder gewünschten Größe angepasst werden. Fuge zwischen den Teilen 1 mm. Zur Umsetzung des Projekts wird der Plan des Kunden mit genauer Angabe der Maße der zu verkleidenden Wand benötigt. Im Falle von nicht perfekt quadratischen Wänden werden die an den Seiten befindlichen Teile 5 cm länger gelassen.

La junta se vuelve decoración, la separación de la materia adquiere una nueva expresión gracias a la tecnología de la propulsión por chorro de agua. Toda realización puede ser única y personalizada en base al espacio en el que se deberá colocar, la decoración se puede adaptar a cualquier medida requerida. Junta entre las piezas de 1 mm. Para llevar a cabo el proyecto es necesario contar con la planta del cliente, que indica con precisión las medidas de las paredes que hay que revestir. En el caso en el que no se cuente con paredes perfectamente en ángulo agudo, las piezas de los lados tendrán una longitud superior a los 5 cm.





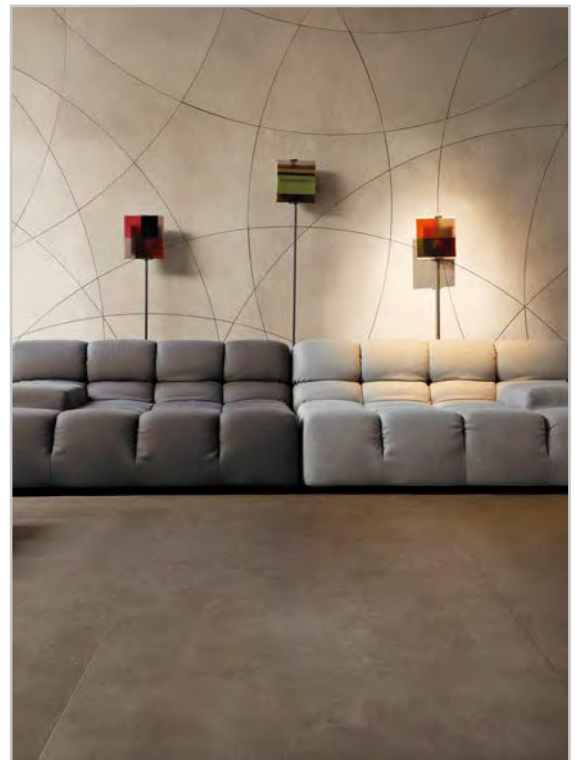
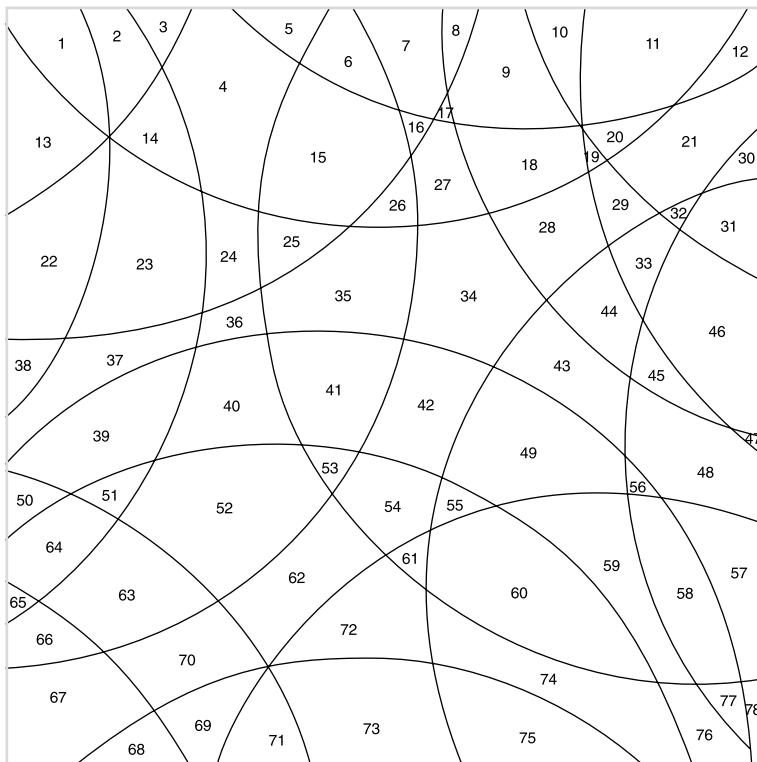



Фуга между плиткой становится декоративным элементом, благодаря гидроструйной технологии линия раздела материала приобретает новую выразительность. Каждое исполнение является уникальным и персонализированным, в зависимости от декорируемого пространства. Декорирование может осуществляться для объектов любых размеров. Фуга между плиткой 1 мм. Для осуществления проекта требуется план помещения клиента с указанием точных размеров стен для облицовки. В том случае, если стены не идеально перпендикулярны и выровнены, то по бокам необходимо удлинение на 5 см.

PUZZLE DECOR 739829 ■ FL-51500













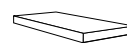

Esempio: per la realizzazione di un pannello di 160x160 cm il consumo sarà di 6 pezzi nel formato 80x80.
Example: covering a 160x160 cm panel will require the use of six 80x80 pieces.
Exemple: pour la réalisation d'un panneau de 160x160 cm, on consommera 6 pièces au format 80x80.
Beispiel: Zur Fertigung einer Platte von 160x160 cm liegt der Verbrauch bei 6 Teilen im Format 80x80.
Ejemplo: para la realización de un panel de 160x160 cm el consumo será de 6 piezas en el formato 80x80.
Например: для изготовления панели 160x160 см требуется 6 шт. плитки форматом 80x80.











Architectural design

10 mm 3/8" ↑		COLOR	SURFACE	30x30 1 1/4" x 1 1/4"  mosaico tessere 3x3	15x60 6" x 2 3/8"  modulo listello mix 3D soft pz/box 6
INDUSTRIAL		IVORY	NATURALE	739130 ■ FL-15600	SAGE-PLOMB-STEEL
		TAUPE	NATURALE	739133 ■ FL-15600	739190 ▲ FL-03600
		MOKA	NATURALE	739134 ■ FL-15600	IVORY-MOKA-TAUPE
		SAGE	NATURALE	739131 ■ FL-15600	739191 ▲ FL-03600
		STEEL	NATURALE	739132 ■ FL-15600	
		PLOMB	NATURALE	739135 ■ FL-15600	

PEZZI SPECIALI/SPECIAL TRIMS/PIÈCES SPÉCIALES/FORMSTÜCKE/PIEZAS ESPECIALES/Специальные изделия

10 mm 3/8" ↑		COLOR	SURFACE	4,6x60 1 4/5" x 2 3/8"  battiscopa	33x120x3 13" x 4 7/8" x 1 1/8"  gradino pz/box 2	33x120x3 13" x 4 7/8" x 1 1/8"  angolo gradino dx pz/box 2	33x120x3 13" x 4 7/8" x 1 1/8"  angolo gradino sx pz/box 2	33x120x3 13" x 4 7/8" x 1 1/8"  angolo gradino dx/sx pz/box 1	15x60x6 6" x 2 3/8" x 2 1/8"  elemento elle pz/box 4
INDUSTRIAL		IVORY	NATURALE	745535 ◆ FL-01600	739142 ▲ FL-20400	739148 ▲ FL-31100	739154 ▲ FL-31100	739422 ▲ FL-42900	-
			SOFT	745541 ◆ FL-01600	739160 ▲ FL-20400	739166 ▲ FL-31100	739172 ▲ FL-31100	739428 ▲ FL-42900	-
			BOCCIARDATO	-	-	-	-	-	739136 ▲ FL-03600
		TAUPE	NATURALE	745540 ◆ FL-01600	739145 ▲ FL-20400	739151 ▲ FL-31100	739157 ▲ FL-31100	739425 ▲ FL-42900	-
			SOFT	745546 ◆ FL-01600	739163 ▲ FL-20400	739169 ▲ FL-31100	739175 ▲ FL-31100	739431 ▲ FL-42900	-
			BOCCIARDATO	-	-	-	-	-	739139 ▲ FL-03600
		MOKA	NATURALE	745536 ◆ FL-01600	739146 ▲ FL-20400	739152 ▲ FL-31100	739158 ▲ FL-31100	739426 ▲ FL-42900	-
			SOFT	745542 ◆ FL-01600	739164 ▲ FL-20400	739170 ▲ FL-31100	739176 ▲ FL-31100	739432 ▲ FL-42900	-
			BOCCIARDATO	-	-	-	-	-	739140 ▲ FL-03600
		SAGE	NATURALE	745538 ◆ FL-01600	739143 ▲ FL-20400	739149 ▲ FL-31100	739155 ▲ FL-31100	739423 ▲ FL-42900	-
			SOFT	745544 ◆ FL-01600	739161 ▲ FL-20400	739167 ▲ FL-31100	739173 ▲ FL-31100	739429 ▲ FL-42900	-
			BOCCIARDATO	-	-	-	-	-	739137 ▲ FL-03600
		STEEL	NATURALE	745539 ◆ FL-01600	739144 ▲ FL-20400	739150 ▲ FL-31100	739156 ▲ FL-31100	739424 ▲ FL-42900	-
			SOFT	745545 ◆ FL-01600	739162 ▲ FL-20400	739168 ▲ FL-31100	739174 ▲ FL-31100	739430 ▲ FL-42900	-
			BOCCIARDATO	-	-	-	-	-	739138 ▲ FL-03600
		PLOMB	NATURALE	745537 ◆ FL-01600	739147 ▲ FL-20400	739153 ▲ FL-31100	739159 ▲ FL-31100	739427 ▲ FL-42900	-
			SOFT	745543 ◆ FL-01600	739165 ▲ FL-20400	739171 ▲ FL-31100	739177 ▲ FL-31100	739433 ▲ FL-42900	-
			BOCCIARDATO	-	-	-	-	-	739141 ▲ FL-03600

INDUSTRIAL

6 mm 1/4" ↑ ↓							PEZZI SPECIALI/SPECIAL TRIMS PIÈCES SPÉCIALES/FORMSTÜCKE PIEZAS ESPECIALES/Специальные изделия
	COLOR	SURFACE	30x30 11 4/5" x 11 4/5"  mosaico tessere 7,5x7,5 pz/box 11	30x30 11 4/5" x 11 4/5"  muretto tessere 7,5x15 pz/box 11	30x30 11 4/5" x 11 4/5"  mosaico tessere 1,5x3 pz/box 11	4,6x80 1 4/5" x 31 1/2"  battiscopa	
INDUSTRIAL		IVORY	NATURALE	747722 ▲ FL-01800	747732 ▲ FL-01800	747742 ▲ FL-02700	747857 ◆ FL-01800
		TAUPE	NATURALE	747723 ▲ FL-01800	747733 ▲ FL-01800	747743 ▲ FL-02700	747858 ◆ FL-01800
		MOKA	NATURALE	747724 ▲ FL-01800	747734 ▲ FL-01800	747744 ▲ FL-02700	747859 ◆ FL-01800
		SAGE	NATURALE	747725 ▲ FL-01800	747735 ▲ FL-01800	747745 ▲ FL-02700	747860 ◆ FL-01800
		STEEL	NATURALE	747726 ▲ FL-01800	747736 ▲ FL-01800	747746 ▲ FL-02700	747861 ◆ FL-01800
		PLOMB	NATURALE	747727 ▲ FL-01800	747737 ▲ FL-01800	747747 ▲ FL-02700	747862 ◆ FL-01800

INDUSTRIAL	scatola - box			pallet		
	pz	mq	kg	box	mq	kg
60x120	2	1,44	33,00	30	43,20	1030
80x80	2	1,28	30,00	40	51,20	1220
40x80	3	0,96	22,00	56	53,76	1260
60x60	3	1,08	24,00	40	43,20	990
30x60	6	1,08	24,00	40	43,20	990
20x80	6	0,96	21,00	48	46,08	1050
30x30 mosaico	11	1,00	23,00	30	30,00	720
puzzle decor	1	1,00	23,00	6	6,00	170

INDUSTRIAL	scatola - box			pallet		
	pz	ml	kg	box	mq	kg
4,6x60 battiscopa	14	8,40	8,40	-	-	-

FLORIM OVERSIZE
magnum

160x320/120x280/120x240/120x120/60x120
 Specifica Imballo pag.
 Packaging specifications on page
 Spécifications d'emballage à page
 Verpackungsdetail Seite
 Especificaciones de embalaje a la página
 Информация об упаковке на стр.
176/177

Per un effetto ottimale della posa, florim suggerisce di mantenere 2 mm di fuga per pose monofornate e 3 mm per combinare formati misti - For optimal installation results, florim recommends maintaining a joint of 2 mm 1/12" for single format installations and 3 mm 1/8" to combine mixed formats. - Pour réaliser une pose parfaite, florim suggère de maintenir 2 mm de joint pour la pose des monofornats, et 3 mm pour les combinaisons de formats mixtes. - Um einen optimalen effekt beim verlegen zu erzielen empfiehlt florim eine 2 mm fuge bei einformatigen verlegungen und 3 mm fuge bei formatkombinationen Para lograr los máximos resultados en la posa del producto, florim aconseja 2 mm de junta en aplicaciones monofornate y 3 mm en combinaciones de formatos mixtos - **ДЛЯ ОПТИМАЛЬНОЙ УКЛАДКИ " FLORIM" РЕКОМЕНДУЕТ ВЫДЕРЖИВАТЬ ЗАЗОР 2 ММ ДЛЯ МОНОФОРМАТА И 3 ММ ПРИ СМЕШАННЫХ ФОРМАТАХ.**

In relazione alle differenti tecnologie produttive l'accostamento di prodotti con spessori diversi potrebbe presentare delle disomogeneità, se ne sconsiglia pertanto l'abbinamento. / Due to the different production technologies, contiguous installation of products with different thickness may give a non-homogeneous result. For this reason we do not recommend this option. / Vu que différentes technologies de production sont utilisées avec des épaisseurs différentes, des problèmes d'homogénéité pourraient se présenter, il est donc déconseillé de les poser ensemble. / Wegen unterschiedlicher Produktionstechnologien können die Fliesen mit verschiedenen Materialstärken optische Differenzen aufweisen. Von einem direkten Aneinanderlegen wird deshalb abgeraten. / Dadas las diferentes tecnologías productivas, la combinación de productos de diferentes espesores podría dar lugar a heterogeneidad, por lo que se desaconseja mezclarlas. / **В связи с различием в технологиях производства, сочетание продукции разной толщины иногда может представлять неоднородность материала. Такие сочетания следует избегать.**



INDUSTRIAL OUTDOOR

Vantaggi tecnici - Technical advantages - Avantages techniques Technische Vorteile - Ventajas técnicas - Технические преимущества

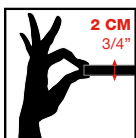

- Lastra monolitica compatta di spessore 2 cm squadrata e rettificata
- Compact monolithic slab 2 cm thick squared and rectified
- Dalle monolithique compacte de 2 cm d'épaisseur, équarrie et rectifiée
- Kompakte monolithische Platte, 2 cm dick, rechteckig und scharfkantig geschliffen
- Losa monolítica compacta de 2 cm de espesor, escuadrada y rectificada.
- Монолитная плотная плита толщиной 2 см, с обрезанными и выровненными кромками

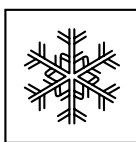

- INGELIVO
- FROST RESISTANT
- INGÉLIF
- FROSTBESTÄNDIG
- RESISTENTE A LA HELADA
- МОРОЗОСТОЙКАЯ

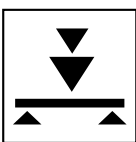

- ELEVATA RESISTENZA AI CARICHI STATICI
- HIGH STATIC LOAD RESISTANCE
- RÉSISTANCE ÉLEVÉE AUX CHARGES STATIQUES
- HOHE STATISCHE BELASTBARKEIT
- ELEVADA RESISTENCIA A LAS CARGAS ESTÁTICAS
- ВЫДЕРЖИВАЕТ БОЛЬШИЕ СТАТИЧЕСКИЕ НАГРУЗКИ

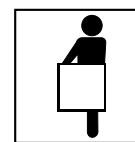

- FACILE DA POSARE
- EASY TO INSTALL
- FACILE À POSER
- VERLEGELEICHT
- FÁCIL DE COLOCAR
- ЛЕГКО УКЛАДЫВАЕТСЯ



- ANTISCIVOLO R11
- ANTI SLIP R11
- ANTIDÉRAPANT R11
- RUTSCHFEST R11
- ANTIDESLIZANTE R11
- НЕСКОЛЬЗКАЯ - R11

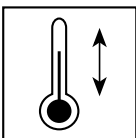

- RESISTENTE AGLI SBALZI TERMICI
- THERMAL SHOCK RESISTANT
- RÉSISTANT AUX ÉCARTS THERMIQUES
- TEMPERATURWECHSELBESTÄNDIG
- RESISTENTE A LAS OSCILACIONES TÉRMICAS
- СТОЙКАЯ К ТЕПЛОВЫМ ПЕРЕПАДАМ



- FACILE DA PULIRE
- EASY TO CLEAN
- FACILE À NETTOYER
- REINIGUNGSLEICHT
- FÁCIL DE LIMPIAR
- ЛЕГКО ЧИСТИТСЯ

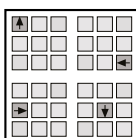

- RIMOVIBILE E RIUTILIZZABILE
- REMOVABLE AND REUSABLE
- DÉMONTABLE ET RÉUTILISABLE
- ENTFERNBAR UND WIEDERVERWENDBAR
- DESMONTABLE Y REUTILIZABLE
- МОЖЕТ СНИМАТЬСЯ И ПОВТОРНО ИСПОЛЬЗОВАТЬСЯ



- INATTACCABILE DA AGENTI CHIMICI E MUFFE
- IMPERVIUS TO ATTACK BY CHEMICALS OR MOULD
- RÉSISTANT AUX AGENTS CHIMIQUES ET AUX MOISSISSURES
- UNANGREIFBAR DURCH CHEMISCHE STOFFE UND SCHIMMEL
- RESISTENTE A LOS AGENTES QUÍMICOS Y A LOS MOHOS
- НЕ ПОДВЕРГАЕТСЯ ВОЗДЕЙСТВИЮ ХИМИЧЕСКИХ ВЕЩЕСТВ И ПЛЕСЕНИ

Applicazioni - Applications - Applications - Verlegung - Aplicaciones - Применения

- Posa diretta su erba
- Direct installation on grass
- Pose direct sur de l'herbe
- Verlegung direkt auf Rasen
- Colocación directa sobre hierba
- Прямая укладка на траву

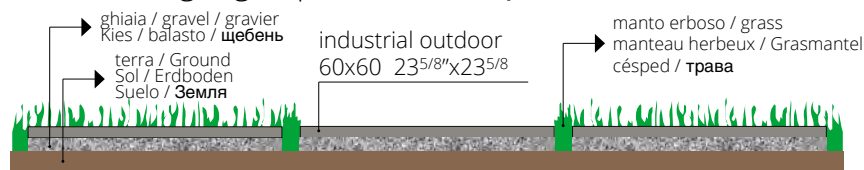

- Posa diretta su ghiaia
- Direct installation over gravel
- Pose direct sur du gravier
- Verlegung direkt auf Kies
- Colocación directa sobre grava
- Прямая укладка на гальку



- Posa su massetto cementizio
- Installation on sand-cement screed
- Pose sur chape ciment
- Verlegung auf Zement-Unterbetonblock
- Colocación sobre contrapiso de hormigón
- Укладка на цементную стяжку

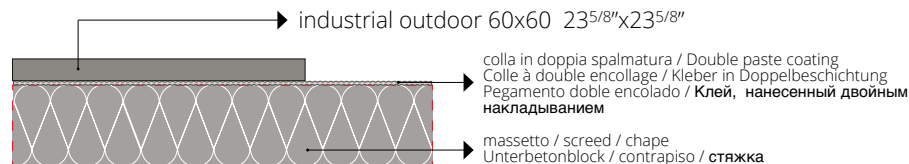

- Posa su piedini fissi o regolabili
- Installation on fixed or adjustable feet
- Pose sur pieds fixes ou réglables
- Verlegung auf feststehende oder regulierbare Füße
- Colocación sobre pies fijos o regulables
- Укладка на фиксированных или регулируемых ножках

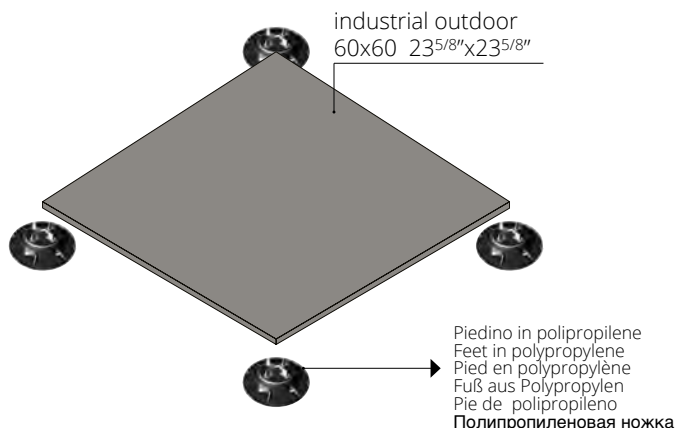

Per le specifiche di utilizzo dei sistemi sopraelevati vedi il sito florim.com
For the specifics on use of raised systems visit the site florim.com
Pour les caractéristiques d'utilisation des systèmes surélevés, voir le site florim.com
Für die Nutzungsbedingungen der Doppelbodensysteme siehe Webseite florim.com
Para las especificaciones de empleo de los sistemas sobreelevados consulte el sitio web florim.com
Технические характеристики систем фальшполов см. на сайте florim.com

Le lastre ceramiche sono sottoposte a un trattamento di compattazione termica che assicura resistenza e durata nel tempo. Il bassissimo assorbimento d'acqua rende perciò il materiale ingelivo. Ciò può comportare ristagni d'acqua superficiali anche per materiale installato a regola d'arte. / Ceramic tiles undergo a compacting thermal treatment that ensures resistance and durability. The low level of water absorption makes the slabs frost resistant. This could result in superficial water stagnations even if materials are installed in a workmanlike manner. / Les carreaux de céramique subissent un traitement thermique qui assure résistance et durabilité. Le bas niveau d'absorption d'eau rend les dalles résistant au gel. Il pourrait en résulter des stagnations d'eau superficielles, même si les dalles ont été installées dans les règles de l'art. / Die Keramikplatten werden einer thermischen Verdichtung unterzogen, welche die Widerstandsfähigkeit und Langlebigkeit sichert. Die extrem niedrige Wasseraufnahme macht das Material frostsicher. Die hohe Materialdichte kann, auch bei einer perfekten Verlegung, eine längere Abtrocknungszeit von angestauntem Wasser zur Folge haben. / Las baldosas cerámicas se someten a un tratamiento de compactación térmica que asegura resistencia y durabilidad. La baja absorción de agua hace que las baldosas resistan al hielo. Esto podría resultar en estancamientos superficiales de agua, incluso si los materiales están instalados según las reglas del arte. / Керамическая плитка подвергается термическому уплотнению, что обеспечивает ей прочность и износостойкость. За счёт очень низкого водопоглощения она не промерзает, при этом даже при правильной укладке возможны застои воды на поверхности плитки.

IVORY



TAUPE

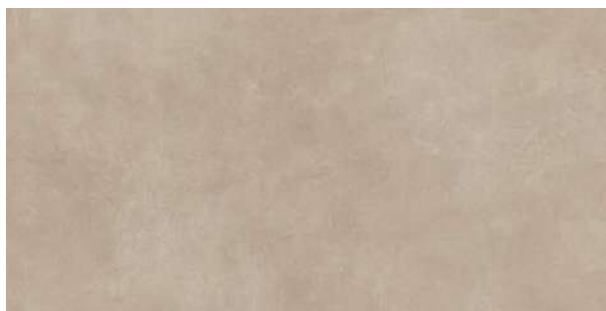

R11
CLASSE C

DCOF >
0,42 Wet

20 mm 3/4" ↑↓

MOKA

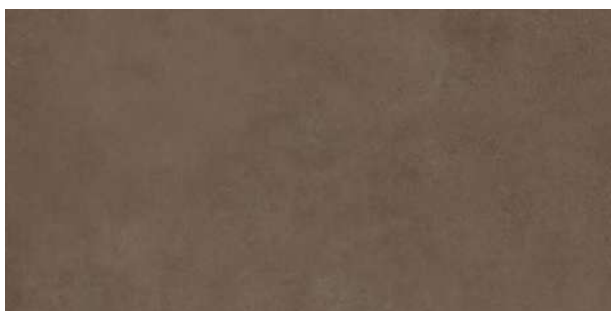

SAGE



STEEL



PLOMB



GRES FINE PORCELLANATO

FINE PORCELAIN STONEWARE/GRES CERAME FIN/FEINSTEINZEUG-KOLLEKTIONEN/GRES PORCELANICO FINO/ФАРФОРОВЫЙ КЕРАМОГРАНИТ
SQUADRATO - SQUARED - EQUARRI - REKTIFIZIERT - ESCUADRADO - КАЛИБРОВАННАЯ

20 mm 3/4" ↑↓

	COLOR	SURFACE	60x60 23 ^{5/8} "x23 ^{5/8} "
INDUSTRIAL	IVORY	BOCCIARDATO	738961 ■ FL-09300
	TAUPE	BOCCIARDATO	738964 ■ FL-09300
	MOKA	BOCCIARDATO	738965 ■ FL-09300
	SAGE	BOCCIARDATO	738962 ■ FL-09300
	STEEL	BOCCIARDATO	738963 ■ FL-09300
	PLOMB	BOCCIARDATO	738966 ■ FL-09300

	RESISTENZA ALLA FLESSIONE IN N/mm² <small>N/mm² FLEXURAL STRENGTH TEST / RESISTANCE A LA FLEXION EN N/mm² / BIEGEFESTIGKEIT IN N/mm² / RESISTENCIA A LA FLEXION EN N/mm² / УСТОЙЧИВОСТЬ К ИЗГИБУ В Н/мм²</small>	valore medio 52 N/mm²
	Forza di rottura in N (sp. > 7,5 mm) <small>Breaking strength in N (thickness > 7,5 mm) / Force de rupture en N (ep. > 7,5 mm) / Bruchlast in N (Dicke > 7,5 mm) / Разрушающее усилие, Н (толщ. > 7,5 мм)</small>	valore medio 14000 N

PEZZI SPECIALI

Special trims/Pièces spéciales/Formstücke
Piezas especiales/СПЕЦИАЛЬНЫЕ ИЗДЕЛИЯ
pag 166/169

INDUSTRIAL	scatola - box			pallet		
	pz	m ²	kg	box	m ²	kg
60x60 20mm	2	0,72	32,10	30	21,60	990



PISCINE

interno/esterno vasca

inside/outside the pool

becken/aussenbereich

interieur/extérieur du bassin

interiores/revestimientos exteriores de piscinas

ВНУТРЕННЯЯ ПОЛОСТЬ БАСЕЙНА НАРУЖНАЯ ЧАСТЬ БАСЕЙНА



PISCINE INTERNO VASCA LISCIO SM - GRIP SM/A+B+C

BIANCO

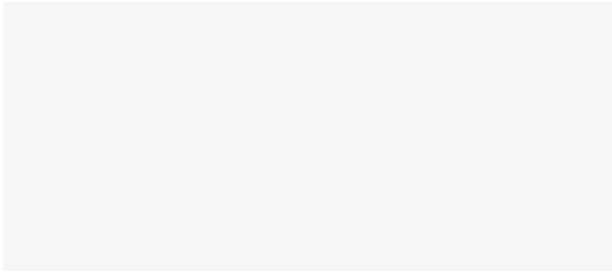

TURCHESE CHIARO

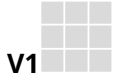

liscio sm

7,4 mm 1/4" ↑↓

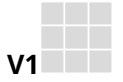

Classe C
(grip SM)

7,4 mm 1/4" ↑↓

BONE

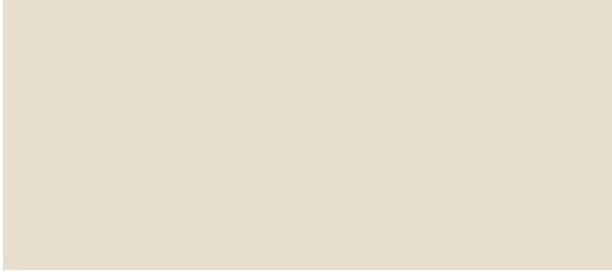

BLU MARINO



NERO



BLU ELETTRICO



GRES PORCELLANATO SMALTATO

GLAZED PORCELAIN STONEWARE / GRES CÉRAME ÉMAILLÉ / GLASIERTE FEINSTEINZEUG / GRES PORCELÁNICO ESMALTADO / Глазурованный керамогранит

7,4 mm 1/4" ↑↓				M12,5x25 5"x9 ^{5/8"}	M12,5x25 5"x9 ^{5/8"}	M24,5x3 9 ^{7/8"} x1 ^{1/8"}	M24,5x3 9 ^{7/8"} x1 ^{1/8"}	3x3 1 ^{1/8"} x1 ^{1/8"}	3x3 1 ^{1/8"} x1 ^{1/8"}	3x3 1 ^{1/8"} x1 ^{1/8"}	3x3 1 ^{1/8"} x1 ^{1/8"}
	COLOR	SURFACE		BC pz/box 42	CS2 pz/box 60	RP2 pz/box 60	BE2 pz/box 18	BI2 pz/box 18	RA/E2 pz/box 4	RA/I2 pz/box 4	
PISCINE	BIANCO	LISCIO SM	006286 ■ FL-03380	006618 ▲ FL-00720	006297 ▲ FL-00870	006292 ▲ FL-00870	006307 ▲ FL-01160	006302 ▲ FL-01160	008167 ▲ FL-01160	008617 ▲ FL-01160	
		GRIP SM	006312 ■ FL-03920	006319 ▲ FL-00720	703579 ▲ FL-00920	-	703582 ▲ FL-01160	-	-	703583 ▲ FL-01160	
	BONE	LISCIO SM	012167 ■ FL-03380	705621 ▲ FL-00720	-	-	-	-	-	-	
PISCINE	NERO	LISCIO SM	006288 ■ FL-05100	-	-	-	-	-	-	-	
		GRIP SM	011451 ■ FL-05100	011453 ▲ FL-01200	-	-	-	-	-	-	
PISCINE	TURCHESE CHIARO	LISCIO SM	006285 ■ FL-03380	006617 ▲ FL-00720	006296 ▲ FL-00870	006291 ▲ FL-00870	006306 ▲ FL-01160	006301 ▲ FL-01160	008166 ▲ FL-01160	008618 ▲ FL-01160	
		GRIP SM	006311 ■ FL-03920	006318 ▲ FL-00720	703578 ▲ FL-00920	-	703580 ▲ FL-01160	-	-	703581 ▲ FL-01160	
	BLU MARINO	LISCIO SM	006287 ■ FL-03380	-	-	-	-	-	-	-	
PISCINE	BLU ELETTRICO	LISCIO SM	006289 ■ FL-05100	006616 ▲ FL-00870	006300 ▲ FL-00920	006295 ▲ FL-00920	006310 ▲ FL-01160	006305 ▲ FL-01160	012191 ▲ FL-01160	012188 ▲ FL-01160	
		GRIP SM	011450 ■ FL-05100	011452 ▲ FL-00960	703572 ▲ FL-01020	-	703576 ▲ FL-01160	-	-	703577 ▲ FL-01160	

M12,5x25 (5"x9^{5/8"})

La superficie di vendita è calcolata sulla base della dimensione convenzionale, uguale alla dimensione nominale più una fuga di 5 mm.

Sales area calculated on the basis of the standard size, equal to the nominal size plus a 5 mm joint.
Surface de vente calculées sur la base de la dimension conventionnelle, égale à la dimension nominale plus joint de 5 mm.
Verkaufsfläche unter Kalkulation auf der Grundlage konventioneller Abmessungen gleich der Nennabmessungen plus einer Fuge von 5 mm.
Реализационная площадь плитки рассчитывается на базе условного размера, равного номинальной площади плюс швы 5 мм.

ESTERNO VASCA MOD 2/25

WHITE

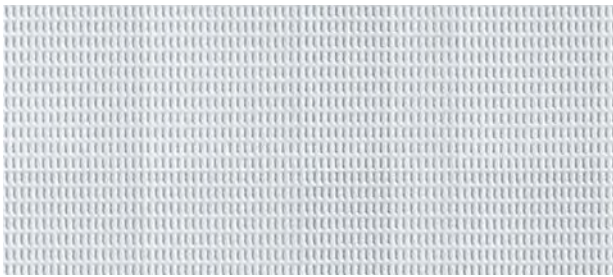

CELESTE

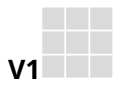
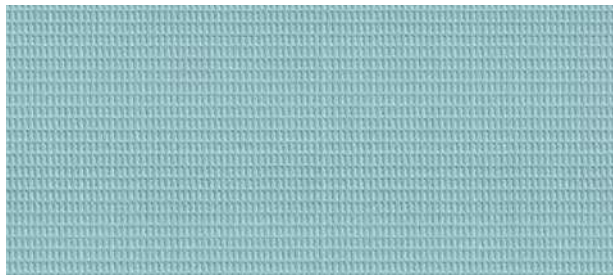

Classe C
(mod 2/25)

7,8 mm 3/8" ↑↓

AVORIO

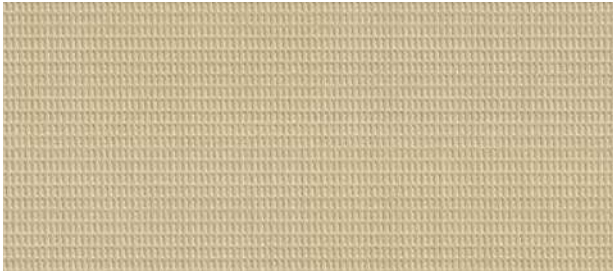

GRES FINE PORCELLANATO

FINE PORCELAIN STONEWARE/GRES CERAME FIN/FEINSTEINZEUG-KOLLEKTIONEN/GRES PORCELANICO FINO/ФАРФОРОВЫЙ КЕРАМОГРАНИТ

7,8 mm 3/8" ↑↓		COLOR	12,5x25 5"x9 5/8"	12,5x25 5"x9 5/8"	7,8 mm 3/8" ↑↓		COLOR	12,5x25 5"x9 5/8"
			MOD 2/25	MOD 2/25 BC pz/box 42				MOD 2/25 BC pz/box 42
		WHITE	011415 ■ FL-04400	011419 ▲ FL-00720			WHITE/BLU	011423 ▲ FL-01030
PISCINE		CELESTE	011416 ■ FL-06500	011420 ▲ FL-00920	PISCINE		CELESTE/BLU	011424 ▲ FL-01200
		AVORIO STONE	703548 ■ FL-03600	703553 ▲ FL-00720			WHITE/NERO	011425 ▲ FL-00960

GRES FINE PORCELLANATO







FINE PORCELAIN STONEWARE/GRES CERAME FIN/FEINSTEINZEUG-KOLLEKTIONEN/GRES PORCELANICO FINO/ФАРФОРОВЫЙ КЕРАМОГРАНИТ







7,8 mm 3/8" ↑↓		COLOR	12,5x25 5"x9 5/8"	12,5x25 5"x9 5/8"
			MOD 2/25 GRIP	MOD 2/25 BC GRIP pz/box 40
		BIANCO	012278 ■ FL-16100	012287 ▲ FL-02350
PISCINE		BIANCO/BLU	-	774918 ▲ FL-02700
		BIANCO/NERO	-	774919 ▲ FL-02700



PISCINE	scatola - box			pallet		
	pz	mq	kg	box	mq	kg
LISCIO SM / GRIP SM A+B+C M12,5x25	30	0,94	13,20	75	70,50	1010
MOD. 2/25 12,5x25	40	1,25	20,50	45	56,25	950



PISCINE

PEZZI SPECIALI/SPECIAL TRIMS/PIÈCES SPÉCIALES/FORMSTÜCKE/PIEZAS ESPECIALES/Специальные изделия

	COLOR	M25x15 9 ^{5/8} "x5 ^{7/8} "  MOD 3/S AG pz/box 10	M15x15 5 ^{7/8} "x5 ^{7/8} "  MOD 3/S AG AI pz/box 10	M12,5x12,5 5"x5"  MOD 3/S AG AE pz/box 20	M25x27,5 9 ^{5/8} "x10 ^{3/4} "  MOD 3/G AG pz/box 5	M27,5x27,5 10 ^{3/4} "x10 ^{3/4} "  MOD 3/G AG AI pz/box 5	25x25 9 ^{5/8} "x9 ^{5/8} "  MOD 3/G AE pz/box 4
PISCINE	AVORIO BIANCO/ BLU ELETTRICO	729417 ▲ FL-02200	729419 ▲ FL-02840	729420 ▲ FL-02700	723609 ▲ FL-03700	723610 ▲ FL-07700	726720 ▲ FL-07700

	COLOR	25x12,5 9 ^{5/8} "x5"  MOD 3/R pz/box 14	12,5x12,5 5"x5"  MOD 3/R AI pz/box 1	12,5x12,5 5"x5"  MOD 3/R AE pz/box 1	COLOR	25x12,5 9 ^{5/8} "x5"  MOD 3/R GRIP pz/box 14	12,5x12,5 5"x5"  MOD 3/R AI GRIP pz/box 1	12,5x12,5 5"x5"  MOD 3/R AE GRIP pz/box 1
	WHITE	728412 ▲ FL-02000	728487 ▲ FL-04400	728488 ▲ FL-04400	BIANCO	774909 ▲ FL-02350	774912 ▲ FL-05100	774915 ▲ FL-05100
PISCINE	WHITE/BLU ELETTRICO	705561 ▲ FL-02000	705735 ▲ FL-04400	705738 ▲ FL-04400	BIANCO/BLU	774910 ▲ FL-02820	774913 ▲ FL-05100	774916 ▲ FL-05100
	WHITE/NERO	705733 ▲ FL-02000	705743 ▲ FL-04400	705744 ▲ FL-04400	BIANCO/NERO	774911 ▲ FL-02820	774914 ▲ FL-05100	774917 ▲ FL-05100

	COLOR	M25x12,5x3,5 9 ^{5/8} "x5"x1 ^{3/8} "  MOD 11/S pz/box 12	12,5x12,5x3,5 5"x5"x1 ^{3/8} "  MOD 11/S AI pz/box 12	12,5x12,5 5"x5"  MOD 11/S AE pz/box 12
PISCINE	AVORIO BIANCO	006278 ▲ FL-02350	006279 ▲ FL-03670	006280 ▲ FL-03670

	COLOR	M25x23x15 9 ^{5/8} "x9 ^{1/4} "x5 ^{7/8} "  MOD 8/S pz/box 4	M25x30x15 9 ^{5/8} "x11 ^{3/4} "x5 ^{7/8} "  MOD 8/L pz/box 3	M25x23x15 9 ^{5/8} "x9 ^{1/4} "x5 ^{7/8} "  MOD 4/S pz/box 4
PISCINE	BIANCO	006200 ▲ FL-06940	006216 ▲ FL-08100	-
	TURCHESE CHIARO	006199 ▲ FL-06940	006215 ▲ FL-08100	006231 ▲ FL-06940

La gamma completa dei pezzi speciali è disponibile sull'Organizer Piscine / Special pieces full range is available on Organizer Piscine / La gamme complète des pièces spéciales est disponible sur Organizer Piscine / Das gesamte Bandbreite der Spezialteile ist im Schwimmbäder-Katalog verfügbar. / La gama completa de piezas especiales es disponible en el Organizer Piscine / Вы найдете целый ассортимент специальных изделий на генеральном каталоге "Piscine"





ARCHITECTURAL DESIGN / FLOOR GRES / 128



RAWTECH

gres fine porcellanato
fine porcelain stoneware
grès cérame fin
feinsteinzeug-kollektionen
gres porcelánico fino
фарфоровый керамогранит

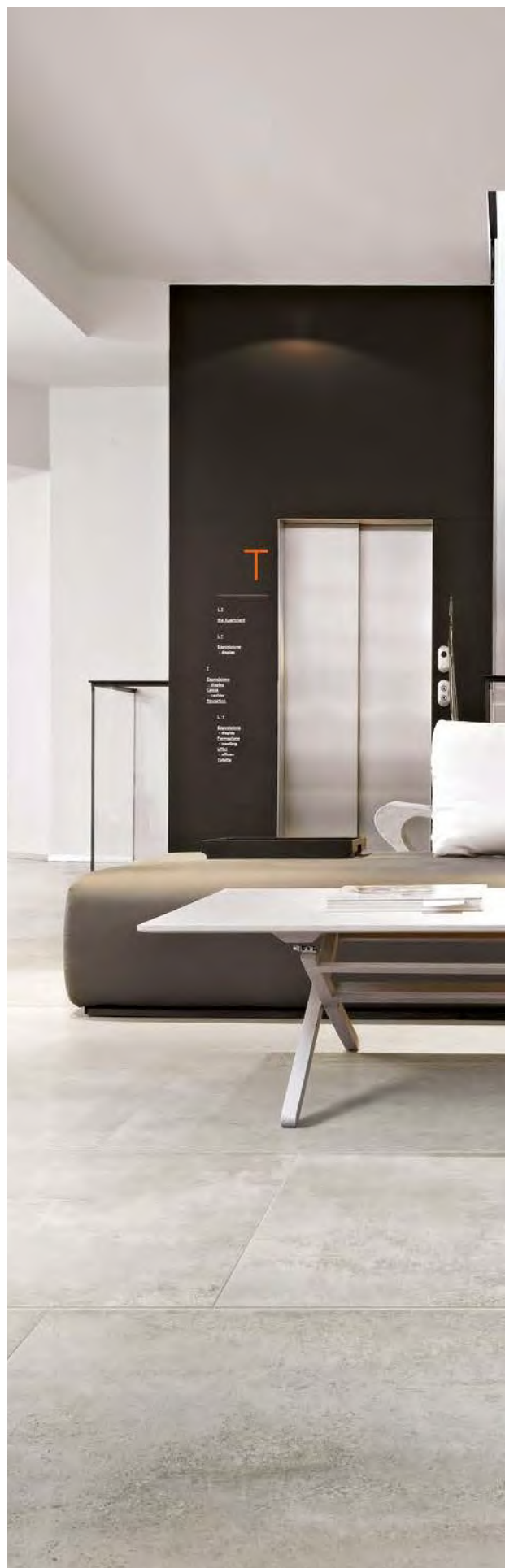



RAWTECH

Un cemento vissuto, usurato dal tempo in cui l'imperfezione diventa il segno distintivo. **Rawtech** è il frutto di un atteggiamento progettuale che vuole recuperare il carattere identitario di un prodotto marcatamente industriale per riportarlo con gusto contemporaneo alle esigenze dell'abitare più sofisticato. Un cemento vissuto, usurato dal tempo in cui l'imperfezione diventa il segno distintivo e requisito fondamentale per esprimere al meglio uno stile inconfondibile.

Rawtech is the result of a design approach which aims to recapture the true identity of an essentially industrial product and at the same time appeal to the sophisticated demands of contemporary living styles. A tile with experience, worn by time, where imperfection becomes a hallmark, a prerequisite to better express its truly unmistakable style.

Rawtech est le fruit d'une réflexion en matière de conception qui vise à se réappropriier le caractère identitaire d'un produit résolument industriel pour le rapprocher, dans un style contemporain, des exigences d'un habitat plus sophistiqué. Un ciment ancien, usé par le passage du temps, où l'imperfection est un signe distinctif et un prérequis fondamental pour exprimer au mieux un style unique.

Rawtech ist das Ergebnis eines Designerstils, der die Identitätseigenschaften eines ausgesprochen industriellen Produkts zurückgewinnen und sie an die Bedürfnisse eines zeitgenössischen, anspruchsvolleren Wohnens anpassen möchte. Eine gelebte, mit der Zeit abgenutzte Fliese mit Betoneffekt, auf der die Unvollkommenheit zum Kennzeichen und damit zur Grundvoraussetzung eines unvergleichlichen Stils wird.

Rawtech es fruto de un planteamiento proyectual que desea recuperar el carácter identificador de un producto fuertemente industrial para satisfacer con gusto contemporáneo las necesidades de la vivienda más sofisticada. Un cemento para disfrutar, gastado por el tiempo, en el que la imperfección se convierte en signo distintivo y requisito fundamental para expresar lo mejor posible un estilo inconfundible.

Rawtech является плодом проектного подхода, направленного на воссоздание истинного характера материала сугубо промышленного назначения для того, чтобы пересмотреть его в современном вкусе и привести его в соответствие с требованиями самого изысканного дизайна интерьеров. Коллекция воспроизводит бывший в употреблении, изношенный цемент, на котором недостатки становятся отличительными чертами и незаменимым реквизитом для удачного выражения несравненного стиля.

RAW-WHITE

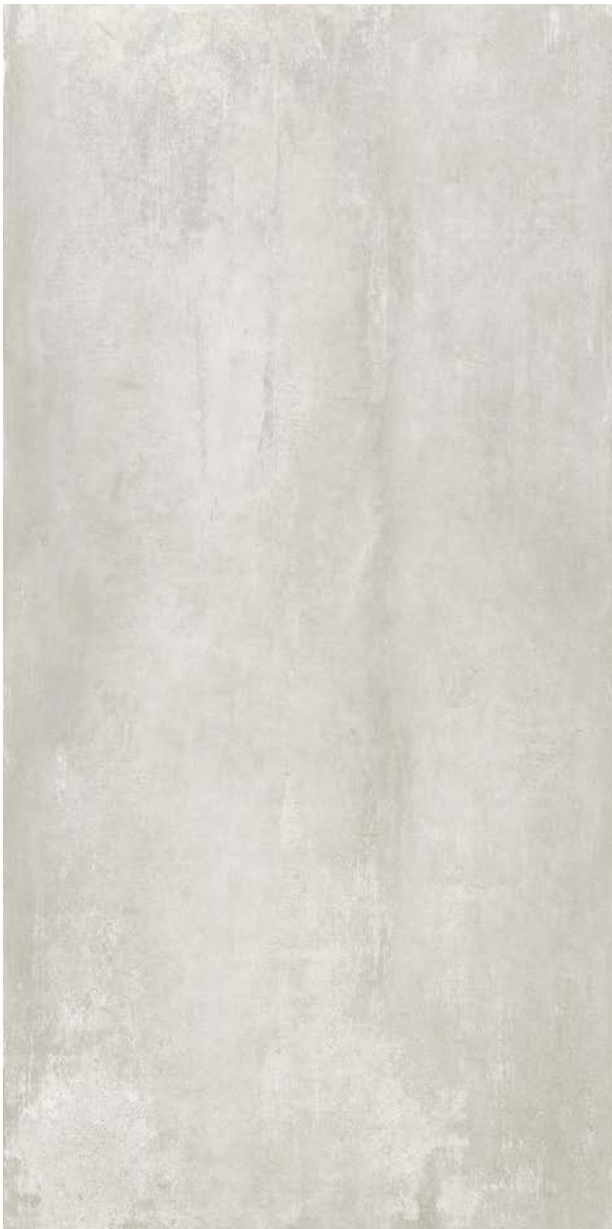

RAW-MUD



V2
RAW-WHITE

V3
RAW-MUD

R10
Classe B
(naturale)

R11
Classe A+B
(strutturato)

DCOF>
0,42 Wet

10 mm 3/8" ↑↓

V2
RAW-WHITE

V3
RAW-MUD

R9
Classe A

DCOF>
0,42 Wet

6 mm 1/4" ↑↓

FLORIM OVERSIZE
magnum

GRES FINE PORCELLANATO

FINE PORCELAIN STONEWARE / GRÈS CÉRAME FIN / FEINSTEINZEUG-KOLLEKTIONEN / GRES PORCELÁNICO FINO / фарфоровый керамогранит

SQUADRATO - SQUARED - EQUARRI - REKTIFIZIERT - ESCUADRADO - КАЛИБРОВАННА

10 mm 3/8" ↑↓		COLOR	SURFACE	80x180 31 1/2" x 70 5/8"	60x120 23 5/8" x 47 1/4"	80x80 31 1/2" x 31 1/2"	40x80 15 3/4" x 31 1/2"	60x60 23 5/8" x 23 5/8"	30x60 11 4/8" x 23 5/8"
RAWTECH	RAW-WHITE	NATURALE		752184 ■ FL-10500	752196 ■ FL-08100	752188 ■ FL-08100	752192 ■ FL-05800	752200 ■ FL-05300	752204 ■ FL-04600
		STRUTTURATO		-	-	-	-	753922 ■ FL-05300	752208 ■ FL-04600
	RAW-MUD	NATURALE		752186 ■ FL-10500	752198 ■ FL-08100	752190 ■ FL-08100	752194 ■ FL-05800	752202 ■ FL-05300	752206 ■ FL-04600
		STRUTTURATO		-	-	-	-	753923 ■ FL-05300	752210 ■ FL-04600
6 mm 1/4" ↑↓		COLOR	SURFACE	120x240 47 1/4" x 94 1/2"	120x120 47 1/4" x 47 1/4"	60x120 23 5/8" x 47 1/4"			
RAWTECH	RAW-WHITE	NATURALE		757825 ■ FL-09900	757821 ■ FL-08400	757817 ■ FL-07700			

RAW-DUST



RAW-COAL



V3

R10
Classe B
(naturale)

R11
Classe A+B
(strutturato)

DCOF>
0,42 Wet

10 mm 3/8" ↑↓



V3

R9
Classe A

DCOF>
0,42 Wet

6 mm 1/4" ↑↓

FLOHM OVERSIZE
magnum







GRES FINE PORCELLANATO

FINE PORCELAIN STONEWARE / GRÈS CÉRAME FIN / FEINSTEINZEUG-KOLLEKTIONEN / GRES PORCELÁNICO FINO / фарфоровый керамогранит









SQUADRATO - SQUARED - EQUARRI - REKTIFIZIERT - ESCUADRADO - КАЛИБРОВАННА

10 mm 3/8" ↑↓		COLOR	SURFACE	80x180 31 ^{1/2"} x70 ^{5/7"}	60x120 23 ^{5/8"} x47 ^{1/4"}	80x80 31 ^{1/2"} x31 ^{1/2"}	40x80 15 ^{3/4"} x31 ^{1/2"}	60x60 23 ^{5/8"} x23 ^{5/8"}	30x60 11 ^{4/5"} x23 ^{5/8"}
RAWTECH		NATURALE		752187 ■ FL-10500	752199 ■ FL-08100	752191 ■ FL-08100	752195 ■ FL-05800	752203 ■ FL-05300	752207 ■ FL-04600
		STRUTTURATO		-	-	-	-	753924 ■ FL-05300	752211 ■ FL-04600
		NATURALE		752185 ■ FL-10500	752197 ■ FL-08100	752189 ■ FL-08100	752193 ■ FL-05800	752201 ■ FL-05300	752205 ■ FL-04600
		STRUTTURATO		-	-	-	-	753925 ■ FL-05300	752209 ■ FL-04600
6 mm 1/4" ↑↓		COLOR	SURFACE	120x240 47 ^{1/4"} x94 ^{1/2"}	120x120 47 ^{1/4"} x47 ^{1/4"}	60x120 23 ^{5/8"} x47 ^{1/4"}			
RAWTECH		RAW-DUST	NATURALE	757826 ■ FL-09900	757822 ■ FL-08400	757818 ■ FL-07700			

RAWTECH

10 mm 3/8" ↑↓				30x30 11 4/5" x 11 4/5"  mosaico tessere 3x3 pz/box 11	21x40 8 1/4" x 15 3/4"  modulo listello sfalsato pz/box 5
	COLOR		SURFACE		
RAWTECH		RAW-WHITE	NATURALE	753904 ▲ FL-01600	752212 ▲ FL-01600
		RAW-MUD	NATURALE	753905 ▲ FL-01600	752214 ▲ FL-01600
		RAW-DUST	NATURALE	753906 ▲ FL-01600	752215 ▲ FL-01600
		RAW-COAL	NATURALE	753907 ▲ FL-01600	752213 ▲ FL-01600

PEZZI SPECIALI/SPECIAL TRIMS/PIÈCES SPÉCIALES/FORMSTÜCKE/PIEZAS ESPECIALES/Специальные изделия

10 mm 3/8" ↑↓				4,6x60 1 4/5" x 23 5/8"  battiscopa	33x120x3 13" x 47 1/4" x 1 1/8"  gradino pz/box 2	33x120x3 13" x 47 1/4" x 1 1/8"  angolo gradino dx pz/box 2	33x120x3 13" x 47 1/4" x 1 1/8"  angolo gradino sx pz/box 2	33x120x3 13" x 47 1/4" x 1 1/8"  angolo gradino dx/sx pz/box 1
	COLOR		SURFACE					
RAWTECH		RAW-WHITE	NATURALE	752216 ◆ FL-01600	753908 ▲ FL-20400	753912 ▲ FL-31100	753916 ▲ FL-31100	754092 ▲ FL-42900
		RAW-MUD	NATURALE	752218 ◆ FL-01600	753909 ▲ FL-20400	753913 ▲ FL-31100	753917 ▲ FL-31100	754093 ▲ FL-42900
		RAW-DUST	NATURALE	752219 ◆ FL-01600	753910 ▲ FL-20400	753914 ▲ FL-31100	753918 ▲ FL-31100	754094 ▲ FL-42900
		RAW-COAL	NATURALE	752217 ◆ FL-01600	753911 ▲ FL-20400	753915 ▲ FL-31100	753919 ▲ FL-31100	754095 ▲ FL-42900

FLORIM OVERSIZE
magnum

120x240/120x120/60x120

Specifica Imballo pag.
Packaging specifications on page
Spécifications d'emballage à page
Verpackungsdetail Seite
Especificaciones de embalaje a la página
Информация об упаковке на стр.
176/177

RAWTECH	scatola - box			pallet		
	pz	mq	kg	box	mq	kg
80x180	2	2,88	67,00	20	57,60	1400
60x120	2	1,44	32,00	30	43,20	990
80x80	2	1,28	30,00	40	51,20	1220
60x60	3	1,08	24,00	40	43,20	990
40x80	3	0,96	22,00	56	53,76	1260
30x60	6	1,08	24,00	40	43,20	990

RAWTECH	scatola - box			pallet		
	pz	ml	kg	box	mq	kg
4,6x60 battiscopa	14	8,40	8,40	-	-	-

Per un effetto ottimale della posa, florim suggerisce di mantenere 2 mm di fuga per pose monofornato e 3 mm per combinare formati misti - For optimal installation results, florim recommends maintaining a joint of 2 mm 1/12" for single format installations and 3 mm 1/8" to combine mixed formats. - Pour réaliser une pose parfaite, florim suggère de maintenir 2 mm de joint pour la pose des monofornats, et 3 mm pour les combinaisons de formats mixtes. - Um einen optimalen effekt beim verlegen zu erzielen empfiehlt florim eine 2 mm fuge bei einformatigen verlegungen und 3 mm fuge bei formatkombinationen Para lograr los máximos resultados en la posa del producto, florim aconseja 2 mm de junta en aplicaciones monofornato y 3 mm en combinaciones de formatos mixtos - **ДЛЯ ОПТИМАЛЬНОЙ УКЛАДКИ " FLORIM" РЕКОМЕНДУЕТ ВЫДЕРЖИВАТЬ ЗАЗОР 2 ММ ДЛЯ МОНОФОРМАТА И 3 ММ ПРИ СМЕШАННЫХ ФОРМАТАХ.**

In relazione alle differenti tecnologie produttive l'accostamento di prodotti con spessori diversi potrebbe presentare delle disomogeneità, se ne sconsiglia pertanto l'abbinamento. / Due to the different production technologies, contiguous installation of products with different thickness may give a non-homogeneous result. For this reason we do not recommend this option. / Vu que différentes technologies de production sont utilisées avec des épaisseurs différentes, des problèmes d'homogénéité pourraient se présenter, il est donc déconseillé de les poser ensemble. / Wegen unterschiedlicher Produktionstechnologien können die Fliesen mit verschiedenen Materialstärken optische Differenzen aufweisen. Von einem direkten Aneinanderlegen wird deshalb abgeraten. / Dadas las diferentes tecnologías productivas, la combinación de productos de diferentes espesores podría dar lugar a heterogeneidad, por lo que se desaconseja mezclarlas. / **В связи с различием в технологиях производства, сочетание продукции разной толщины иногда может представлять неоднородность материала. Такие сочетания следует избегать.**



RAWTECH OUTDOOR

Vantaggi tecnici - Technical advantages - Avantages techniques Technische Vorteile - Ventajas técnicas - Технические преимущества

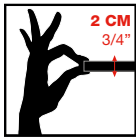

- Lastra monolitica compatta di spessore 2 cm squadrata e rettificata
- Compact monolithic slab 2 cm thick squared and rectified
- Dalle monolithique compacte de 2 cm d'épaisseur, équarrie et rectifiée
- Kompakte monolithische Platte, 2 cm dick, rechteckig und scharfkantig geschliffen
- Losa monolítica compacta de 2 cm de espesor, escuadrada y rectificada.
- Монолитная плотная плита толщиной 2 см, с обрезанными и выровненными кромками

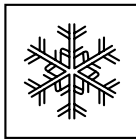

- INGELIVO
- FROST RESISTANT
- INGÉLIF
- FROSTBESTÄNDIG
- RESISTENTE A LA HELADA
- МОРОЗОСТОЙКАЯ

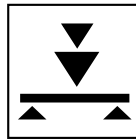

- ELEVATA RESISTENZA AI CARICHI STATICI
- HIGH STATIC LOAD RESISTANCE
- RÉSISTANCE ÉLEVÉE AUX CHARGES STATIQUES
- HOHE STATISCHE BELASTBARKEIT
- ELEVADA RESISTENCIA A LAS CARGAS ESTÁTICAS
- ВЫДЕРЖИВАЕТ БОЛЬШИЕ СТАТИЧЕСКИЕ НАГРУЗКИ

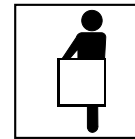

- FACILE DA POSARE
- EASY TO INSTALL
- FACILE À POSER
- VERLEGELEICHT
- FÁCIL DE COLOCAR
- ЛЕГКО УКЛАДЫВАЕТСЯ



- ANTISCIVOLO R11
- ANTI SLIP R11
- ANTIDÉRAPANT R11
- RUTSCHFEST R11
- ANTIDESLIZANTE R11
- НЕСКОЛЬЗКАЯ - R11

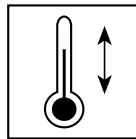

- RESISTENTE AGLI SBALZI TERMICI
- THERMAL SHOCK RESISTANT
- RÉSISTANT AUX ÉCARTS THERMIQUES
- TEMPERATURWECHSELBESTÄNDIG
- RESISTENTE A LAS OSCILACIONES TÉRMICAS
- СТОЙКАЯ К ТЕПЛОВЫМ ПЕРЕПАДАМ



- FACILE DA PULIRE
- EASY TO CLEAN
- FACILE À NETTOYER
- REINIGUNGSLEICHT
- FÁCIL DE LIMPIAR
- ЛЕГКО ЧИСТИТСЯ

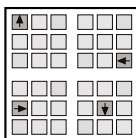

- RIMOVIBILE E RIUTILIZZABILE
- REMOVABLE AND REUSABLE
- DÉMONTABLE ET RÉUTILISABLE
- ENTFERNBAR UND WIEDERVERWENDBAR
- DESMONTABLE Y REUTILIZABLE
- МОЖЕТ СНИМАТЬСЯ И ПОВТОРНО ИСПОЛЬЗОВАТЬСЯ



- INATTACCABILE DA AGENTI CHIMICI E MUFFE
- IMPERVIOUS TO ATTACK BY CHEMICALS OR MOULD
- RÉSISTANT AUX AGENTS CHIMIQUES ET AUX MOISSISSURES
- UNANGREIFBAR DURCH CHEMISCHE STOFFE UND SCHIMMEL
- RESISTENTE A LOS AGENTES QUÍMICOS Y A LOS MOHOS
- НЕ ПОДВЕРГАЕТСЯ ВОЗДЕЙСТВИЮ ХИМИЧЕСКИХ ВЕЩЕСТВ И ПЛЕСЕНИ

Applicazioni - Applications - Applications - Verlegung - Aplicaciones - Применения

- Posa diretta su erba
- Direct installation on grass
- Pose direct sur de l'herbe
- Verlegung direkt auf Rasen
- Colocación directa sobre hierba
- Прямая укладка на траву



- Posa diretta su ghiaia
- Direct installation over gravel
- Pose direct sur du gravier
- Verlegung direkt auf Kies
- Colocación directa sobre grava
- Прямая укладка на гальку



- Posa su massetto cementizio
- Installation on sand-cement screed
- Pose sur chape ciment
- Verlegung auf Zement-Unterbetonblock
- Colocación sobre contrapiso de hormigón
- Укладка на цементную стяжку

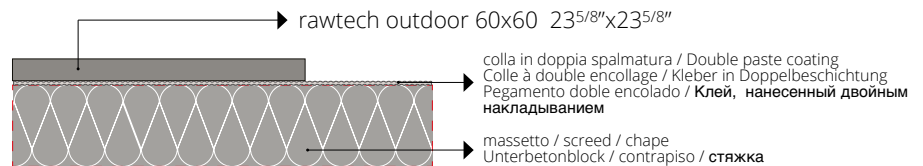

- Posa su piedini fissi o regolabili
- Installation on fixed or adjustable feet
- Pose sur pieds fixes ou réglables
- Verlegung auf feststehende oder regulierbare Füße
- Colocación sobre pies fijos o regulables
- Укладка на фиксированных или регулируемых ножках

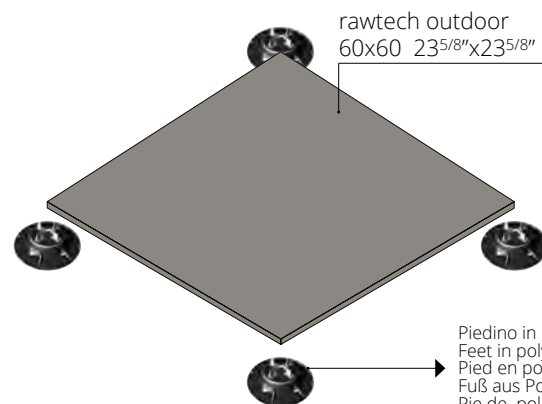

Per le specifiche di utilizzo dei sistemi sopraelevati vedi il sito florim.com
For the specifics on use of raised systems visit the site florim.com
Pour les caractéristiques d'utilisation des systèmes surélevés, voir le site florim.com
Für die Nutzungsbedingungen der Doppelbodensysteme siehe Webseite florim.com
Para las especificaciones de empleo de los sistemas sobreelevados consulte el sitio web florim.com
Технические характеристики систем фальшполов см. на сайте florim.com

Le lastre ceramiche sono sottoposte a un trattamento di compattazione termica che assicura resistenza e durata nel tempo. Il bassissimo assorbimento d'acqua rende perciò il materiale ingelivo. Ciò può comportare ristagni d'acqua superficiali anche per materiale installato a regola d'arte. / Ceramic tiles undergo a compacting thermal treatment that ensures resistance and durability. The low level of water absorption makes the slabs frost resistant. This could result in superficial water stagnations even if materials are installed in a workmanlike manner. / Les carreaux de céramique subissent un traitement thermique qui assure résistance et durabilité. Le bas niveau d'absorption d'eau rend les dalles résistant au gel. Il pourrait en résulter des stagnations d'eau superficielles, même si les dalles ont été installées dans les règles de l'art. / Die Keramikplatten werden einer thermischen Verdichtung unterzogen, welche die Widerstandsfähigkeit und Langlebigkeit sichert. Die extrem niedrige Wasseraufnahme macht das Material frostsicher. Die hohe Materialdichte kann, auch bei einer perfekten Verlegung, eine längere Abtrocknungszeit von angestauntem Wasser zur Folge haben. / Las baldosas cerámicas se someten a un tratamiento de compactación térmica que asegura resistencia y durabilidad. La baja absorción de agua hace que las baldosas resistan al hielo. Esto podría resultar en estancamientos superficiales de agua, incluso si los materiales están instalados según las reglas del arte. / Керамическая плитка подвергается термическому уплотнению, что обеспечивает ей прочность и износостойкость. За счёт очень низкого водопоглощения она не промерзает, при этом даже при правильной укладке возможны застои воды на поверхности плитки.

RAW-WHITE

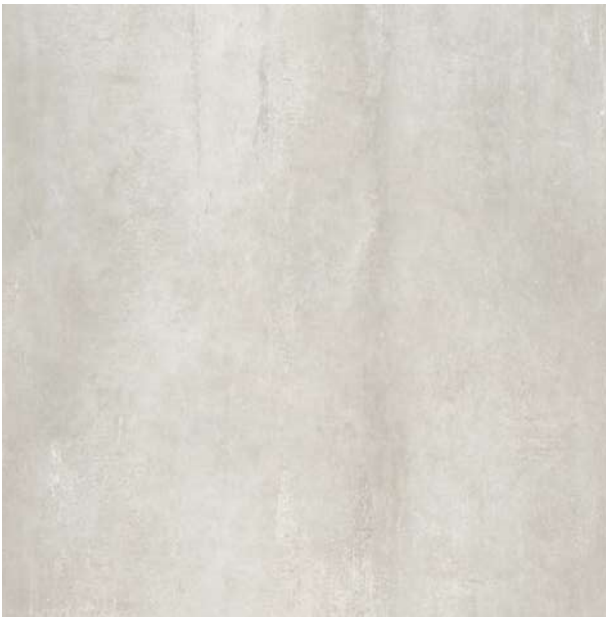

RAW-MUD

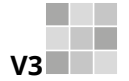

R11
CLASSE
A+B

DCOF >
0,42 Wet

20 mm 3/4" ↑↓

RAW-DUST



RAW-COAL

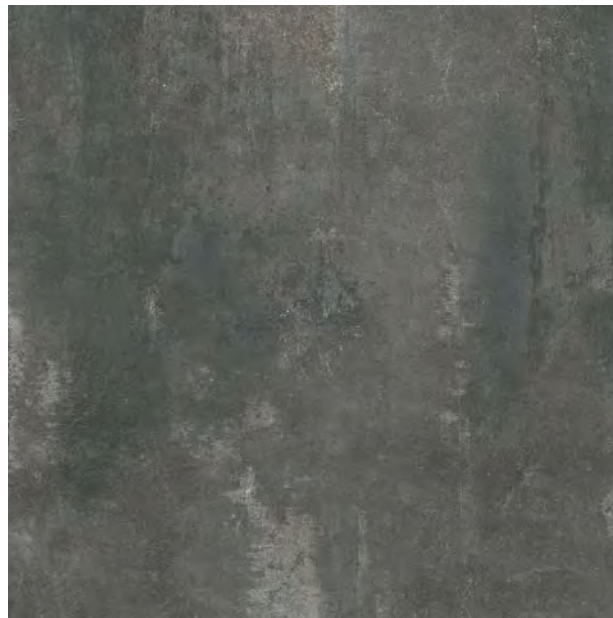

GRES FINE PORCELLANATO

FINE PORCELAIN STONEWARE/GRES CERAME FIN/FEINSTEINZEUG-KOLLEKTIONEN/GRES PORCELANICO FINO/ФАРФОРОВЫЙ КЕРАМОГРАНИТ
SQUADRATO - SQUARED - EQUARRI - REKTIFIZIERT - ESCUADRADO - КАЛИБРОВАННАЯ

20 mm 3/4" ↑↓

	COLOR	SURFACE	60x120 23 ⁵ / ₈ "x47 ¹ / ₄ "	60x60 23 ⁵ / ₈ "x23 ⁵ / ₈ "
RAWTECH	RAW-WHITE	STRUTTURATO	762773 ■ FL-11300	762732 ■ FL-09300
	RAW-MUD	STRUTTURATO	-	762734 ■ FL-09300
	RAW-DUST	STRUTTURATO	762774 ■ FL-11300	762735 ■ FL-09300
	RAW-COAL	STRUTTURATO	-	762733 ■ FL-09300

PEZZI SPECIALI

Special trims/Pièces spéciales/Formstücke
Piezas especiales/СПЕЦИАЛЬНЫЕ ИЗДЕЛИЯ
pag 166/169

ISO 10545-4	RESISTENZA ALLA FLESSIONE IN N/mm ² N/mm ² FLEXURAL STRENGTH TEST / RESISTANCE A LA FLEXION EN N/mm ² / BIEGEFESTIGKEIT IN N/mm ² / RESISTENCIA A LA FLEXION EN N/mm ² / УСТОЙЧИВОСТЬ К ИЗГИБУ В Н/мм ²	valore medio 52 N/mm ²
	Forza di rottura in N (sp. > 7,5 mm) Breaking strength in N (thickness > 7,5 mm) / Force de rupture en N (ép. > 7,5 mm) / Bruchlast in N (Dicke > 7,5 mm) / Fuerza de rotura en N (gr. > 7,5 mm) / Разрывное усилие, Н (толщ. > 7,5 мм)	valore medio 14000 N

RAWTECH	scatola - box			pallet		
	pz	mq	kg	box	mq	kg
60x120 20mm	1	0,72	32,30	30	21,60	990
60x60 20mm	2	0,72	32,10	30	21,60	990



STONTECH/4.0

gres fine porcellanato
fine porcelain stoneware
grès cérame fin
feinsteinzeug-kollektionen
gres porcelánico fino
фарфоровый керамогранит





STONTECH/4.0

Progettare è un processo permanente di riflessione in cui seguire un percorso logico pur lasciando spazio alle emozioni, per questo Floorgres ha deciso di riprogettare la serie **Stontech** che da tempo accompagna il suo modo di interpretare l'abitare. Nuove superfici, nuovi formati e 3 differenti finiture compongono un racconto contemporaneo attento al dettaglio secondo la filosofia del marchio. Due marmi in finitura high-gloss regalano alla serie frammenti di luce preziosa e i grandi formati della famiglia Magnum oversize, in quattro colori, permettono di comporre soluzioni volumetriche inusuali dal forte valore architettonico.

Designing projects is an ongoing process of reflection in which a logical path is followed, while leaving room for the emotions. That's why Floorgres has decided to redesign the **Stontech** range, which has long been a part of its way of interpreting living spaces. New surfaces, new sizes and 3 different finishes tell a contemporary tale with careful attention paid to the detail, in accordance with the brand philosophy. Two high-gloss finish marbles give the range rays of precious light and the large sizes belonging to the Magnum Oversize family, in four colours, enable solutions to be created with unusual volumes and a considerable architectural content.

Designing projects is an ongoing process of reflection in which a logical path is followed, while leaving room for the emotions. That's why Floorgres has decided to redesign the **Stontech** range, which has long been a part of its way of interpreting living spaces. New surfaces, new sizes and 3 different finishes tell a contemporary tale with careful attention paid to the detail, in accordance with the brand philosophy. Two high-gloss finish marbles give the range rays of precious light and the large sizes belonging to the Magnum Oversize family, in four colours, enable solutions to be created with unusual volumes and a considerable architectural content.

Die Planungsphase ist ein permanenter Reflexionsprozess, bei dem man einen logischen Weg geht und gleichzeitig dazu Raum für Emotionen lässt. Deshalb hat Floorgres beschlossen, die Serie **Stontech** neu zu gestalten, die seit geraumer Zeit ihre Interpretationslösungen für den Wohnbereich begleitet. Neue Oberflächen, neue Formate und 3 verschiedene Finishes bilden eine zeitgemäße Kollektion, bei der ganz nach der Philosophie der Marke die Liebe zum Detail im Vordergrund steht. Zwei hochglänzende Marmorsteine verleihen der Serie wertvolle Lichtfragmente. Die vier Farben der Großformate der Produktfamilie Magnum Oversize schaffen ungewöhnliche volumetrische Lösungen von hohem architektonischem Wert.

Die Planungsphase ist ein permanenter Reflexionsprozess, bei dem man einen logischen Weg geht und gleichzeitig dazu Raum für Emotionen lässt. Deshalb hat Floorgres beschlossen, die Serie **Stontech** neu zu gestalten, die seit geraumer Zeit ihre Interpretationslösungen für den Wohnbereich begleitet. Neue Oberflächen, neue Formate und 3 verschiedene Finishes bilden eine zeitgemäße Kollektion, bei der ganz nach der Philosophie der Marke die Liebe zum Detail im Vordergrund steht. Zwei hochglänzende Marmorsteine verleihen der Serie wertvolle Lichtfragmente. Die vier Farben der Großformate der Produktfamilie Magnum Oversize schaffen ungewöhnliche volumetrische Lösungen von hohem architektonischem Wert.

Die Planungsphase ist ein permanenter Reflexionsprozess, bei dem man einen logischen Weg geht und gleichzeitig dazu Raum für Emotionen lässt. Deshalb hat Floorgres beschlossen, die Serie **Stontech** neu zu gestalten, die seit geraumer Zeit ihre Interpretationslösungen für den Wohnbereich begleitet. Neue Oberflächen, neue Formate und 3 verschiedene Finishes bilden eine zeitgemäße Kollektion, bei der ganz nach der Philosophie der Marke die Liebe zum Detail im Vordergrund steht. Zwei hochglänzende Marmorsteine verleihen der Serie wertvolle Lichtfragmente. Die vier Farben der Großformate der Produktfamilie Magnum Oversize schaffen ungewöhnliche volumetrische Lösungen von hohem architektonischem Wert.

Создание дизайна интерьера – это процесс непрерывных размышлений, следующий определенной логике, в котором, конечно же, не могут не выражаться и эмоции. Поэтому компания Floorgres решила переосмыслить дизайн коллекции **Stontech**, издавна являющейся выражением ее концепции оформления жилья. Новые типы поверхностей, новые форматы и 3 разных типа отделки повествуют о современности с особым вниманием к деталям в духе философии бренда. Два типа мрамора со сверхглянцевой поверхностью дарят коллекции роскошную игру света, а четыре крупных формата серии Magnum Oversize, представленные в четырех цветах, позволяют применять в оформлении интерьера необычные решения, придающие его архитектуре дополнительную ценность.

STONTECH/4.0

STONE_01



STONE_02

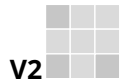

V2

R9
(naturale)

R10
Classe B
(R+PTV)

R11
Classe C
(strutturato)

DCOF>
0,42 Wet
(naturale/
R+PTV/
strutturato)

PTV>36 wet
slider 4S
R+PTV

10 mm 3/8" ↑↓

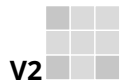

V2

R9
(naturale)

R10
Classe B
(R+PTV)

DCOF>
0,42 Wet
(naturale)

PTV>36 wet
slider 4S
R+PTV

6 mm 1/4" ↑↓



GRES FINE PORCELLANATO

FINE PORCELAIN STONEWARE / GRÈS CÉRAME FIN / FEINSTEINZEUG-KOLLEKTIONEN / GRES PORCELÁNICO FINO / фарфоровый керамогранит
SQUADRATO - SQUARED - EQUARRI - REKTIFIZIERT - ESCUADRADO - КАЛИБРОВАННА

10 mm 3/8" ↑↓		COLOR	SURFACE	60x120 23 ^{5/8"} x47 ^{1/4"}	80x80 31 ^{1/2"} x31 ^{1/2"}	40x80 15 ^{3/4"} x31 ^{1/2"}	60x60 23 ^{5/8"} x23 ^{5/8"}	30x60 11 ^{4/5"} x23 ^{5/8"}
STONE_01	NATURALE	761172 ■ FL-09100		761184 ■ FL-08100	761178 ■ FL-05800	761166 ■ FL-05800	761160 ■ FL-04900	
	HIGH-GLOSSY	761206 ■ FL-10500		761210 ■ FL-09700	761208 ■ FL-07300	761204 ■ FL-07300	761202 ■ FL-06500	
	STRUTTURATO	761212 ■ FL-09100		-	-	-	-	
	CANNETÈ	761218 ■ FL-09100		-	-	-	-	
STONE_01	R+PTV	761190 ■ FL-09100		-	-	761196 ■ FL-05800	761263 ■ FL-04900	
STONE_02	NATURALE	761173 ■ FL-09100		761185 ■ FL-08100	761179 ■ FL-05800	761167 ■ FL-05800	761161 ■ FL-04900	
	STRUTTURATO	761213 ■ FL-09100		-	-	-	-	
	CANNETÈ	761219 ■ FL-09100		-	-	-	-	
	R+PTV	761191 ■ FL-09100		-	-	761197 ■ FL-05800	761264 ■ FL-04900	

6 mm 1/4" ↑↓		COLOR	SURFACE	120x280 47 ^{1/4"} x94 ^{1/2"}	120x240 47 ^{1/4"} x94 ^{1/2"}	120x120 47 ^{1/4"} x47 ^{1/4"}	60x120 23 ^{5/8"} x47 ^{1/4"}
STONE_01	NATURALE	761502 ■ FL-10800		761508 ■ FL-09900	761514 ■ FL-08400	761520 ■ FL-07700	
	HIGH-GLOSSY	761500 ■ FL-13400		761506 ■ FL-12400	761512 ■ FL-10800	761518 ■ FL-10300	
	R+PTV	-		762816 ■ FL-09900	762812 ■ FL-08400	-	
STONE_02	NATURALE	761503 ■ FL-10800		761509 ■ FL-09900	761515 ■ FL-08400	761521 ■ FL-07700	
	R+PTV	-		762817 ■ FL-09900	762813 ■ FL-08400	-	

STONE_03

STONE_04

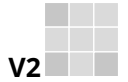

V2

R9
(naturale)

R10
Classe B
(R+PTV)

R11
Classe C
(strutturato)

DCOF>
0,42 Wet
(naturale/
R+PTV/
strutturato)

PTV>36 wet
slider 4S
R+PTV



10 mm 3/8" ↑↓

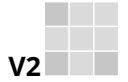

V2

R9
(naturale)

R10
Classe B
(R+PTV)

DCOF>
0,42 Wet
(naturale)

PTV>36 wet
slider 4S
R+PTV



6 mm 1/4" ↑↓

FLOORM OVERSIZE
magnUlm

GRES FINE PORCELLANATO

FINE PORCELAIN STONEWARE / GRÈS CÉRAMÉ FIN / FEINSTEINZEUG-KOLLEKTIONEN / GRES PORCELÁNICO FINO / фарфоровый керамогранит
SQUADRATO - SQUARED - EQUARRI - REKTIFIZIERT - ESCUADRADO - КАЛИБРОВАННА

				10 mm 3/8" ↑↓		60x120 23 ^{5/8} "x47 ^{1/4} "		80x80 31 ^{1/2} "x31 ^{1/2} "		40x80 15 ^{3/4} "x31 ^{1/2} "		60x60 23 ^{5/8} "x23 ^{5/8} "		30x60 11 ^{4/5} "x23 ^{5/8} "	
		COLOR	SURFACE												
STONTECH/4.0	STONE_03	NATURALE	761174 ■ FL-09100	761186 ■ FL-08100	761180 ■ FL-05800	761168 ■ FL-05800	761162 ■ FL-04900								
		STRUTTURATO	761214 ■ FL-09100	-	-	-	-								
		CANNETÈ	761220 ■ FL-09100	-	-	-	-								
		R+PTV	761192 ■ FL-09100	-	-	761198 ■ FL-05800	761265 ■ FL-04900								
	STONE_04	NATURALE	761175 ■ FL-09100	761187 ■ FL-08100	761181 ■ FL-05800	761169 ■ FL-05800	761163 ■ FL-04900								
		STRUTTURATO	761215 ■ FL-09100	-	-	-	-								
		CANNETÈ	761221 ■ FL-09100	-	-	-	-								
		R+PTV	761193 ■ FL-09100	-	-	761199 ■ FL-05800	761266 ■ FL-04900								

				6 mm 1/4" ↑↓		120x280 47 ^{1/4} "x94 ^{1/2} "		120x240 47 ^{1/4} "x94 ^{1/2} "		120x120 47 ^{1/4} "x47 ^{1/4} "		60x120 23 ^{5/8} "x47 ^{1/4} "	
		COLOR	SURFACE										
STONTECH/4.0	STONE_03	NATURALE	761504 ■ FL-10800	761510 ■ FL-09900	761516 ■ FL-08400	761522 ■ FL-07700							
		R+PTV	-	762818 ■ FL-09900	762814 ■ FL-08400	-							

STONTECH/4.0

STONE_05



STONE_06

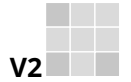

V2

R9
(naturale)

R10
Classe B
(R+PTV)

R11
Classe C
(strutturato)

DCOF>
0,42 Wet
(naturale/
R+PTV/
strutturato)

PTV>36 wet
slider 4S
R+PTV



10 mm 3/8" ↑↓

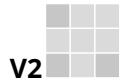

V2

R9
(naturale)

R10
Classe B
(R+PTV)

DCOF>
0,42 Wet
(naturale)

PTV>36 wet
slider 4S
R+PTV



6 mm 1/4" ↑↓

FLORIM OVERSIZE
magnum

GRES FINE PORCELLANATO

FINE PORCELAIN STONEWARE / GRÈS CÉRAME FIN / FEINSTEINZEUG-KOLLEKTIONEN / GRES PORCELÁNICO FINO / фарфоровый керамогранит
SQUADRATO - SQUARED - EQUARRI - REKTIFIZIERT - ESCUADRADO - КАЛИБРОВАННА

10 mm 3/8" ↑↓	COLOR	SURFACE	60x120 23 ^{5/8} "x47 ^{1/4} "	80x80 31 ^{1/2} "x31 ^{1/2} "	40x80 15 ^{3/4} "x31 ^{1/2} "	60x60 23 ^{5/8} "x23 ^{5/8} "	30x60 11 ^{4/5} "x23 ^{5/8} "
---------------	-------	---------	---	--	--	--	--

STONTECH/4.0	STONE_05	NATURALE	761176 ■ FL-09100	761188 ■ FL-08100	761182 ■ FL-05800	761170 ■ FL-05800	761164 ■ FL-04900
		HIGH-GLOSSY	761207 ■ FL-10500	761211 ■ FL-09700	761209 ■ FL-07300	761205 ■ FL-07300	761203 ■ FL-06500
		STRUTTURATO	761216 ■ FL-09100	-	-	-	-
	CANNETÈ	761222 ■ FL-09100	-	-	-	-	
	R+PTV	761194 ■ FL-09100	-	-	761200 ■ FL-05800	761267 ■ FL-04900	
	STONE_06	NATURALE	761177 ■ FL-09100	761189 ■ FL-08100	761183 ■ FL-05800	761171 ■ FL-05800	761165 ■ FL-04900
STRUTTURATO		761217 ■ FL-09100	-	-	-	-	
CANNETÈ		761223 ■ FL-09100	-	-	-	-	
R+PTV		761195 ■ FL-09100	-	-	761201 ■ FL-05800	761268 ■ FL-04900	



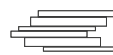

6 mm 1/4" ↑↓	COLOR	SURFACE	120x280 47 ^{1/4} "x94 ^{1/2} "	120x240 47 ^{1/4} "x94 ^{1/2} "	120x120 47 ^{1/4} "x47 ^{1/4} "	60x120 23 ^{5/8} "x47 ^{1/4} "
--------------	-------	---------	--	--	--	---

STONTECH/4.0	STONE_05	NATURALE	761505 ■ FL-10800	761511 ■ FL-09900	761517 ■ FL-08400	761523 ■ FL-07700
		HIGH-GLOSSY	761501 ■ FL-13400	761507 ■ FL-12400	761513 ■ FL-10800	761519 ■ FL-10300
		R+PTV	-	762819 ■ FL-09900	762815 ■ FL-08400	-

Architectural design

10 mm 3/8" ↑↓				30x30 1 1/4" x 1 1/4"	21x40 8 1/4" x 1 5/8"
	COLOR	SURFACE	 mosaico tessere 3x3 pz/box 11	 modulo listello sfalsato	
STONTECH/4.0	STONE_01	NATURALE	761487 ▲ FL-02000	761477 ■ FL-17200	
		HIGH-GLOSSY	761484 ▲ FL-02300	761475 ■ FL-21000	
	STONE_02	NATURALE	761488 ▲ FL-02000	761478 ■ FL-17200	
	STONE_03	NATURALE	761489 ▲ FL-02000	761480 ■ FL-17200	
	STONE_04	NATURALE	761491 ▲ FL-02000	761481 ■ FL-17200	
	STONE_05	NATURALE	761492 ▲ FL-02000	761482 ■ FL-17200	
		HIGH-GLOSSY	761486 ▲ FL-02300	761476 ■ FL-21000	
	STONE_06	NATURALE	761493 ▲ FL-02000	761483 ■ FL-17200	

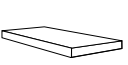
PEZZI SPECIALI/SPECIAL TRIMS/PIÈCES SPÉCIALES/FORMSTÜCKE/PIEZAS ESPECIALES/Специальные изделия

10 mm 3/8" ↑↓				4,6x60 1 4/5" x 23 5/8"	33x120x3 13" x 47 1/4" x 1 1/8"	33x120x3 13" x 47 1/4" x 1 1/8"	33x120x3 13" x 47 1/4" x 1 1/8"
	COLOR	SURFACE	 battiscopa	 gradino pz/box 2	 angolo gradino dx pz/box 2	 angolo gradino sx pz/box 2	
STONTECH/4.0	STONE_01	NATURALE	761451 ◆ FL-01600	761457 ▲ FL-20400	761463 ▲ FL-31100	761469 ▲ FL-31100	
		HIGH-GLOSSY	761449 ◆ FL-01600	-	-	-	
	STONE_02	NATURALE	761452 ◆ FL-01600	761458 ▲ FL-20400	761464 ▲ FL-31100	761470 ▲ FL-31100	
	STONE_03	NATURALE	761453 ◆ FL-01600	761459 ▲ FL-20400	761465 ▲ FL-31100	761471 ▲ FL-31100	
	STONE_04	NATURALE	761454 ◆ FL-01600	761460 ▲ FL-20400	761466 ▲ FL-31100	761472 ▲ FL-31100	
	STONE_05	NATURALE	761455 ◆ FL-01600	761461 ▲ FL-20400	761467 ▲ FL-31100	761473 ▲ FL-31100	
		HIGH-GLOSSY	761450 ◆ FL-01600	-	-	-	
	STONE_06	NATURALE	761456 ◆ FL-01600	761462 ▲ FL-20400	761468 ▲ FL-31100	761474 ▲ FL-31100	

STONTECH/4.0

PEZZI SPECIALI/SPECIAL TRIMS/PIÈCES SPÉCIALES/FORMSTÜCKE/PIEZAS ESPECIALES/Специальные изделия

6 mm 1/4" ↑↓		COLOR	SURFACE	30x30 11 4/5" x 11 4/5" mosaico tessere 7,5x7,5 pz/box 11	30x30 11 4/5" x 11 4/5" muretto tessere 7,5x15 pz/box 11	30x30 11 4/5" x 11 4/5" mosaico tessere 1,5x3 pz/box 11	4,6x80 1 4/5" x 3 1/2" battiscopa
STONTECH/4.0		STONE_01	NATURALE	761439 ▲ FL-01800	761445 ▲ FL-01800	761433 ▲ FL-02700	761427 ◆ FL-01800
		HIGH-GLOSSY	761437 ▲ FL-02100	761443 ▲ FL-02100	761431 ▲ FL-03100	761425 ◆ FL-01800	
		STONE_02	NATURALE	761440 ▲ FL-01800	761446 ▲ FL-01800	761434 ▲ FL-02700	761428 ◆ FL-01800
		STONE_03	NATURALE	761441 ▲ FL-01800	761447 ▲ FL-01800	761435 ▲ FL-02700	761429 ◆ FL-01800
		STONE_05	NATURALE	761442 ▲ FL-01800	761448 ▲ FL-01800	761436 ▲ FL-02700	761430 ◆ FL-01800
		HIGH-GLOSSY	761438 ▲ FL-02100	761444 ▲ FL-02100	761432 ▲ FL-03100	761426 ◆ FL-01800	

FLORIM OVERSIZE
magnum

120x240/120x120/60x120

Specifica Imballo pag.
Packaging specifications on page
Spécifications d'emballage à page
Verpackungsdetail Seite
Especificaciones de embalaje a la página
Информация об упаковке на стр.
176/177

STONTECH/4.0	scatola - box			pallet		
	pz	mq	kg	box	mq	kg
60x120	2	1,44	32,10	30	43,20	990
80x80	2	1,28	29,80	40	51,20	1220
40x80	3	0,96	22,00	56	53,76	1260
60x60	3	1,08	24,10	40	43,20	990
30x60	6	1,08	24,10	40	43,20	990
21x40 modulo listello sfalsato	5	0,42	9,70	40	16,80	410

STONTECH/4.0	scatola - box			pallet		
	pz	ml	kg	box	mq	kg
4,6x60 battiscopa	14	8,40	8,40	-	-	-

Per un effetto ottimale della posa, florim suggerisce di mantenere 2 mm di fuga per pose monofornate e 3 mm per combinare formati misti - For optimal installation results, florim recommends maintaining a joint of 2 mm 1/12" for single format installations and 3 mm 1/8" to combine mixed formats. - Pour réaliser une pose parfaite, florim suggère de maintenir 2 mm de joint pour la pose des monofornats, et 3 mm pour les combinaisons de formats mixtes. - Um einen optimalen effekt beim verlegen zu erzielen empfiehlt florim eine 2 mm fuge bei einformatigen verlegungen und 3 mm fuge bei formatkombinationen Para lograr los máximos resultados en la posa del producto, florim aconseja 2 mm de junta en aplicaciones monofornato y 3 mm en combinaciones de formatos mixtos - **ДЛЯ ОПТИМАЛЬНОЙ УКЛАДКИ " FLORIM " РЕКОМЕНДУЕТ ВЫДЕРЖИВАТЬ ЗАЗОР 2 ММ ДЛЯ МОНОФОРМАТА И 3 ММ ПРИ СМЕШАННЫХ ФОРМАТАХ.**

In relazione alle differenti tecnologie produttive l'accostamento di prodotti con spessori diversi potrebbe presentare delle disomogeneità, se ne sconsiglia pertanto l'abbinamento. / Due to the different production technologies, contiguous installation of products with different thickness may give a non-homogeneous result. For this reason we do not recommend this option. / Vu que différentes technologies de production sont utilisées avec des épaisseurs différentes, des problèmes d'homogénéité pourraient se présenter, il est donc déconseillé de les poser ensemble. / Wegen unterschiedlicher Produktionstechnologien können die Fliesen mit verschiedenen Materialstärken optische Differenzen aufweisen. Von einem direkten Aneinanderlegen wird deshalb abgeraten. / Dadas las diferentes tecnologías productivas, la combinación de productos de diferentes espesores podría dar lugar a heterogeneidad, por lo que se desaconseja mezclarlas. / **В связи с различием в технологиях производства, сочетание продукции разной толщины иногда может представлять неоднородность материала. Такие сочетания следует избегать.**



STONTECH/4.0 OUTDOOR

Vantaggi tecnici - Technical advantages - Avantages techniques Technische Vorteile - Ventajas técnicas - Технические преимущества

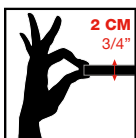

- Lastra monolitica compatta di spessore 2 cm squadrata e rettificata
- Compact monolithic slab 2 cm thick squared and rectified
- Dalle monolithique compacte de 2 cm d'épaisseur, équarrie et rectifiée
- Kompakte monolithische Platte, 2 cm dick, rechteckig und scharfkantig geschliffen
- Losa monolítica compacta de 2 cm de espesor, escuadrada y rectificada.
- Монолитная плотная плита толщиной 2 см, с обрезанными и выровненными кромками

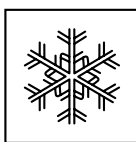

- INGELIVO
- FROST RESISTANT
- INGÉLIF
- FROSTBESTÄNDIG
- RESISTENTE A LA HELADA
- МОРОЗОСТОЯКА

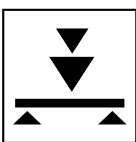

- ELEVATA RESISTENZA AI CARICHI STATICI
- HIGH STATIC LOAD RESISTANCE
- RÉSISTANCE ÉLEVÉE AUX CHARGES STATIQUES
- HOHE STATISCHE BELASTBARKEIT
- ELEVADA RESISTENCIA A LAS CARGAS ESTÁTICAS
- ВЫДЕРЖИВАЕТ БОЛЬШИЕ СТАТИЧЕСКИЕ НАГРУЗКИ

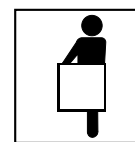

- FACILE DA POSARE
- EASY TO INSTALL
- FACILE À POSER
- VERLEGELEICHT
- FÁCIL DE COLOCAR
- ЛЕГКО УКЛАДЫВАЕТСЯ



- ANTISCIVOLO R11
- ANTI SLIP R11
- ANTIDÉRAPANT R11
- RUTSCHFEST R11
- ANTIDESLIZANTE R11
- НЕСКОЛЬЗКАЯ - R11

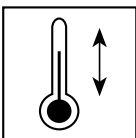

- RESISTENTE AGLI SBALZI TERMICI
- THERMAL SHOCK RESISTANT
- RÉSISTANT AUX ÉCARTS THERMIQUES
- TEMPERATURWECHSELBESTÄNDIG
- RESISTENTE A LAS OSCILACIONES TÉRMICAS
- СТОЙКАЯ К ТЕПЛОВЫМ ПЕРЕПАДАМ



- FACILE DA PULIRE
- EASY TO CLEAN
- FACILE À NETTOYER
- REINIGUNGSLEICHT
- FÁCIL DE LIMPIAR
- ЛЕГКО ЧИСТИТСЯ

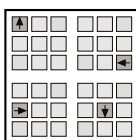

- RIMOVIBILE E RIUTILIZZABILE
- REMOVABLE AND REUSABLE
- DÉMONTABLE ET RÉUTILISABLE
- ENTFERNBAR UND WIEDERVERWENDBAR
- DESMONTABLE Y REUTILIZABLE
- МОЖЕТ СНИМАТЬСЯ И ПОВТОРНО ИСПОЛЬЗОВАТЬСЯ



- INATTACCABILE DA AGENTI CHIMICI E MUFFE
- IMPERVIUS TO ATTACK BY CHEMICALS OR MOULD
- RÉSISTANT AUX AGENTS CHIMIQUES ET AUX MOISSISSURES
- UNANGREIFBAR DURCH CHEMISCHE STOFFE UND SCHIMMEL
- RESISTENTE A LOS AGENTES QUÍMICOS Y A LOS MOHOS
- НЕ ПОДВЕРГАЕТСЯ ВОЗДЕЙСТВИЮ ХИМИЧЕСКИХ ВЕЩЕСТВ И ПЛЕСЕНИ

Applicazioni - Applications - Applications - Verlegung - Aplicaciones - Применения

- Posa diretta su erba
- Direct installation on grass
- Pose direct sur de l'herbe
- Verlegung direkt auf Rasen
- Colocación directa sobre hierba
- Прямая укладка на траву

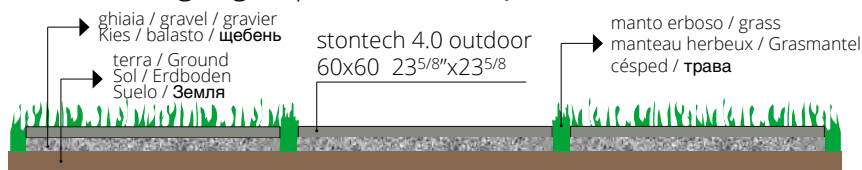

- Posa diretta su ghiaia
- Direct installation over gravel
- Pose direct sur du gravier
- Verlegung direkt auf Kies
- Colocación directa sobre grava
- Прямая укладка на гальку



- Posa su massetto cementizio
- Installation on sand-cement screed
- Pose sur chape ciment
- Verlegung auf Zement-Unterbetonblock
- Colocación sobre contrapiso de hormigón
- Укладка на цементную стяжку

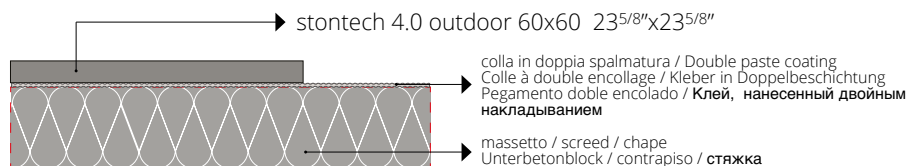

- Posa su piedini fissi o regolabili
- Installation on fixed or adjustable feet
- Pose sur pieds fixes ou réglables
- Verlegung auf feststehende oder regulierbare Füße
- Colocación sobre pies fijos o regulables
- Укладка на фиксированных или регулируемых ножках

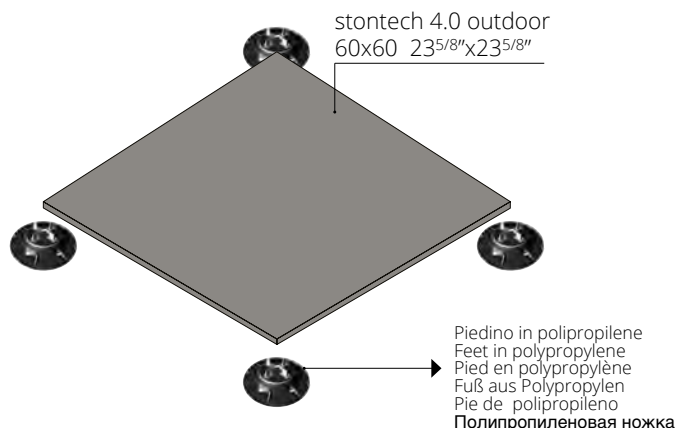

Per le specifiche di utilizzo dei sistemi sopraelevati vedi il sito florim.com
For the specifics on use of raised systems visit the site florim.com
Pour les caractéristiques d'utilisation des systèmes surélevés, voir le site florim.com
Für die Nutzungsbedingungen der Doppelbodensysteme siehe Webseite florim.com
Para las especificaciones de empleo de los sistemas sobreelevados consulte el sitio web florim.com
Технические характеристики систем фальшполов см. на сайте florim.com

Le lastre ceramiche sono sottoposte a un trattamento di compattazione termica che assicura resistenza e durata nel tempo. Il bassissimo assorbimento d'acqua rende perciò il materiale ingelivo. Ciò può comportare ristagni d'acqua superficiali anche per materiale installato a regola d'arte. / Ceramic tiles undergo a compacting thermal treatment that ensures resistance and durability. The low level of water absorption makes the slabs frost resistant. This could result in superficial water stagnations even if materials are installed in a workmanlike manner. / Les carreaux de céramique subissent un traitement thermique qui assure résistance et durabilité. Le bas niveau d'absorption d'eau rend les dalles résistant au gel. Il pourrait en résulter des stagnations d'eau superficielles, même si les dalles ont été installées dans les règles de l'art. / Die Keramikplatten werden einer thermischen Verdichtung unterzogen, welche die Widerstandsfähigkeit und Langlebigkeit sichert. Die extrem niedrige Wasseraufnahme macht das Material frostsicher. Die hohe Materialdichte kann, auch bei einer perfekten Verlegung, eine längere Abtrocknungszeit von angestauntem Wasser zur Folge haben. / Las baldosas cerámicas se someten a un tratamiento de compactación térmica que asegura resistencia y durabilidad. La baja absorción de agua hace que las baldosas resistan al hielo. Esto podría resultar en estancamientos superficiales de agua, incluso si los materiales están instalados según las reglas del arte. / Керамическая плитка подвергается термическому уплотнению, что обеспечивает ей прочность и износостойкость. За счёт очень низкого водопоглощения она не промерзает, при этом даже при правильной укладке возможны застои воды на поверхности плитки.

STONE_01



STONE_02

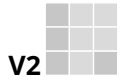

R11
CLASSE C

20 mm 3/4" ↑↓

STONE_03



STONE_04



GRES FINE PORCELLANATO

FINE PORCELAIN STONEWARE/GRES CERAME FIN/FEINSTEINZEUG-KOLLEKTIONEN/GRES PORCELANICO FINO/ФАРФОРОВЫЙ КЕРАМОГРАНИТ
SQUADRATO - SQUARED - EQUARRI - REKTIFIZIERT - ESCUADRADO - КАЛИБРОВАННАЯ

20 mm 3/4" ↑↓

COLOR	SURFACE	60x120 23 ^{5/8"} x47 ^{1/4"}	60x60 23 ^{5/8"} x23 ^{5/8"}
-------	---------	--	---

	STONE_01	STRUTTURATO	762788 ■ FL-11300	-
--	----------	-------------	----------------------	---

	STONE_02	STRUTTURATO	762789 ■ FL-11300	-
--	----------	-------------	----------------------	---

STONTECH/4.0

	STONE_03	STRUTTURATO	762790 ■ FL-11300	761273 ■ FL-09300
--	----------	-------------	----------------------	----------------------

	STONE_04	STRUTTURATO	762791 ■ FL-11300	761274 ■ FL-09300
--	----------	-------------	----------------------	----------------------

Product Certification
BUREAU VERITAS
Certification



Recycled material content certification

20mm
STONE_03 / STONE_04

ISO 10545-4	RESISTENZA ALLA FLESSIONE IN N/mm ² N/mm ² FLEXURAL STRENGTH TEST / RESISTANCE A LA FLEXION EN N/mm ² / BIEGEFESTIGKEIT IN N/mm ² / RESISTENCIA A LA FLEXION EN N/mm ² / УСТОЙЧИВОСТЬ К ИЗГИБУ В Н/мм ²		valore medio 52 N/mm ²
		Forza di rottura in N (sp. > 7,5 mm) Breaking strength in N (thickness > 7,5 mm) / Force de rupture en N (épais. > 7,5 mm) / Bruchlast in N (Dicke > 7,5 mm) / Fuerza de rotura en N (g. > 7,5 mm) / Разрушающее усилие, Н (толщ. > 7,5 мм)	

STONTECH/4.0	scatola - box			pallet		
	pz	mq	kg	box	mq	kg
60x120 20mm	1	0,72	32,30	30	21,60	990
60x60 20mm	2	0,72	32,10	30	21,60	990

PEZZI SPECIALI

Special trims/Pièces spéciales/Formstücke
Piezas especiales/СПЕЦИАЛЬНЫЕ ИЗДЕЛИЯ
pag 166/169



TECH#2

gres fine porcellanato
fine porcelain stoneware
grès cérame fin
feinsteinzeug-kollektionen
gres porcelánico fino
фарфоровый керамогранит





TECH#2

Tech#2 è la nuova soluzione in gres porcellanato autoportante al servizio delle applicazioni outdoor private e pubbliche che permette di coniugare design, prestazioni, versatilità, facilità di posa e sostenibilità ambientale. Composto da materiali riciclati per una percentuale superiore al 70%, Tech#2 è certificato dall'ente Bureau Veritas in accordo con lo standard internazionale ISO 14021. Nei due formati 60x60 e 40x120 Tech#2 è una soluzione di design resistente, durevole e di facile manutenzione. Nel pieno rispetto delle politiche di eco sostenibilità perseguite da Florim negli ultimi anni, la realizzazione di Tech#2 (come quella di tutti i prodotti Florim) non comporta scarichi di acque nell'ambiente esterno, ma grazie ad un processo di depurazione esse vengono reimpiegate nel processo produttivo.

Tech#2 is the new self-supporting porcelain tile solution for outdoor applications in both private and public spaces, enabling design, performance, versatility, easy laying and environmental sustainability to be combined. Comprising over 70% of recycled materials, Tech#2 is certified by Bureau Veritas in accordance with the international ISO 14021 standard. In the two sizes 60x60 cm and 40x120 cm Tech#2 is a tough, long-lasting and easy-maintenance design solution. Tech#2 complies fully with the eco-sustainability policies that Florim has been pursuing in recent years, and is created (as are all Florim products) by not discharging water into the external environment but, through a purification system, by re-using it in the production process.

Tech#2 est une nouvelle solution autoporteuse en grès cérame au service des applications extérieures publiques et privées, alliant design, performances, polyvalence, facilité de pose et durabilité environnementale. Composée de matériaux recyclés à plus de 70 %, Tech#2 est certifiée par Bureau Veritas, conformément à la norme internationale ISO 14021. Les deux formats 60x60 et 40x120 font de Tech#2 une solution design résistante, durable et d'entretien facile. Dans le respect absolu des politiques en matière d'éco-durabilité mises en place par Florim lors des dernières années, la fabrication de Tech#2 (à l'instar de tous les produits Florim) n'entraîne pas de rejets d'eaux dans l'environnement. Grâce à un système d'épuration, celles-ci sont en effet réintroduites dans le processus de production.

Tech#2 ist die neue Lösung aus selbsttragendem Steinzeug für Anwendungen im privaten und öffentlichen Outdoor-Bereich. Sie vereint Design, Leistung, Vielseitigkeit, einfache Verlegbarkeit und Umweltverträglichkeit. Tech#2 besteht zu mehr als 70% aus recycelten Materialien und ist von Bureau Veritas nach dem internationalen Standard ISO 14021 zertifiziert. In den beiden Formaten 60x60 und 40x120 stellt Tech#2 eine widerstandsfähige, dauerhafte und wartungsarme Designlösung dar. Im Einvernehmen mit der in den letzten Jahren von Florim verfolgten Unternehmenspolitik der ökologischen Nachhaltigkeit gelangen bei der Herstellung von Tech#2 (ebenso wie bei allen anderen Florim Produkten) die Abwasser nicht in die Kanalisation, sondern werden dank eines Wasserreinigungssystems in den Produktionsprozess zurückgeführt.

Tech#2 es la nueva solución de gres porcelánico autoportante para ambientes exteriores, privados o públicos, que permite combinar diseño, prestaciones, versatilidad, facilidad de colocación y sostenibilidad ambiental. Compuesto por materiales reciclados en un porcentaje superior al 70 %, Tech#2 está certificado por el ente Bureau Veritas con el estándar internacional ISO 14021. En sus dos formatos —60 x 60 y 40 x 120— Tech#2 es una solución de diseño resistente, duradera y de fácil mantenimiento. En estricto cumplimiento de las políticas de sostenibilidad ambiental adoptadas por Florim en los últimos años, la realización de Tech#2 (como la de todos los productos Florim) no comporta la descarga de aguas en el ambiente exterior; por el contrario, gracias a un proceso de depuración, son reutilizadas en el proceso productivo.

Tech#2 — новое решение на основе самонесущей системы из керамогранита, предназначенное для применения вне помещений для отделки частных и публичных площадей. Оно позволяет объединить дизайн, эксплуатационные характеристики, гибкость, простоту укладки и экологическую совместимость. Состоящий из повторно используемых материалов в процентном соотношении более чем на 70 %, Tech#2 сертифицирован организацией Bureau Veritas в соответствии с международным стандартом ISO 14021. Предлагаемые в двух размерных вариантах (60x60 и 40x120), Tech#2 — это прочные, долговечные и легко обслуживаемые изделия. В полном соответствии с политикой экологической ответственности, проводимой фирмой Florim в последние годы, производство Tech#2 (так же, как и выпуск любой другой продукции фирмы Florim) не влечет за собой слив отработанных вод в окружающую среду. Благодаря применяемой здесь технологии очистки они повторно используются в производственном процессе.

TECH#2

Vantaggi tecnici - Technical advantages - Avantages techniques Technische Vorteile - Ventajas técnicas - Технические преимущества

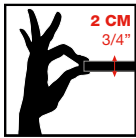

- Lastra monolitica compatta di spessore 2 cm squadrata e rettificata
- Compact monolithic slab 2 cm thick squared and rectified
- Dalle monolithique compacte de 2 cm d'épaisseur, égarrie et rectifiée
- Kompakte monolithische Platte, 2 cm dick, rechteckig und scharfkantig geschliffen
- Losa monolítica compacta de 2 cm de espesor, escuadrada y rectificada.
- Монолитная плотная плита толщиной 2 см, с обрезанными и выровненными кромками

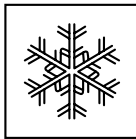

- INGELIVO
- FROST RESISTANT
- INGÉLIF
- FROSTBESTÄNDIG
- RESISTENTE A LA HELADA
- МОРОЗОСТОЙКАЯ

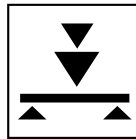

- ELEVATA RESISTENZA AI CARICHI STATICI
- HIGH STATIC LOAD RESISTANCE
- RÉSISTANCE ÉLEVÉE AUX CHARGES STATIQUES
- HOHE STATISCHE BELASTBARKEIT
- ELEVADA RESISTENCIA A LAS CARGAS ESTÁTICAS
- ВЫДЕРЖИВАЕТ БОЛЬШИЕ СТАТИЧЕСКИЕ НАГРУЗКИ

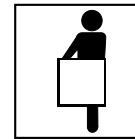

- FACILE DA POSARE
- EASY TO INSTALL
- FACILE À POSER
- VERLEGELEICHT
- FÁCIL DE COLOCAR
- ЛЕГКО УКЛАДЫВАЕТСЯ



- ANTISCIVOLO R12
- ANTI SLIP R12
- ANTIDÉRAPANT R12
- RUTSCHFEST R12
- ANTIDESLIZANTE R12
- НЕСКОЛЬЗКАЯ - R12

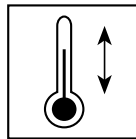

- RESISTENTE AGLI SBALZI TERMICI
- THERMAL SHOCK RESISTANT
- RÉSISTANT AUX ÉCARTS THERMIQUES
- TEMPERATURWECHSELBESTÄNDIG
- RESISTENTE A LAS OSCILACIONES TÉRMICAS
- СТОЙКАЯ К ТЕПЛОВЫМ ПЕРЕПАДАМ



- FACILE DA PULIRE
- EASY TO CLEAN
- FACILE À NETTOYER
- REINIGUNGSLEICHT
- FÁCIL DE LIMPIAR
- ЛЕГКО ЧИСТИТСЯ

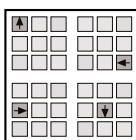

- RIMOVIBILE E RIUTILIZZABILE
- REMOVABLE AND REUSABLE
- DÉMONTABLE ET RÉUTILISABLE
- ENTFERNBAR UND WIEDERVERWENDBAR
- DESMONTABLE Y REUTILIZABLE
- МОЖЕТ СНИМАТЬСЯ И ПОВТОРНО ИСПОЛЬЗОВАТЬСЯ



- INATTACCABILE DA AGENTI CHIMICI E MUFFE
- IMPERVIOUS TO ATTACK BY CHEMICALS OR MOULD
- RÉSISTANT AUX AGENTS CHIMIQUES ET AUX MOISSISSURES
- UNANGREIFBAR DURCH CHEMISCHE STOFFE UND SCHIMMEL
- RESISTENTE A LOS AGENTES QUÍMICOS Y A LOS MOHOS
- НЕ ПОДВЕРГАЕТСЯ ВОЗДЕЙСТВИЮ ХИМИЧЕСКИХ ВЕЩЕСТВ И ПЛЕСЕНИ

Applicazioni - Applications - Applications - Verlegung - Aplicaciones - Применения

- Posa diretta su erba
- Direct installation on grass
- Pose direct sur de l'herbe
- Verlegung direkt auf Rasen
- Colocación directa sobre hierba
- Прямая укладка на траву

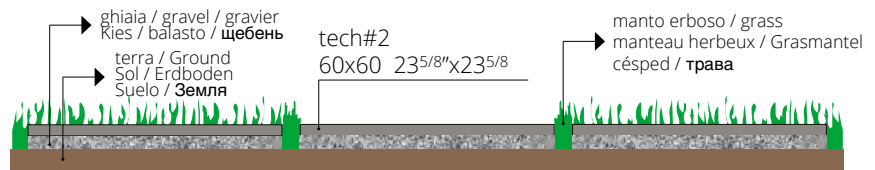

- Posa diretta su ghiaia
- Direct installation over gravel
- Pose direct sur du gravier
- Verlegung direkt auf Kies
- Colocación directa sobre grava
- Прямая укладка на гальку

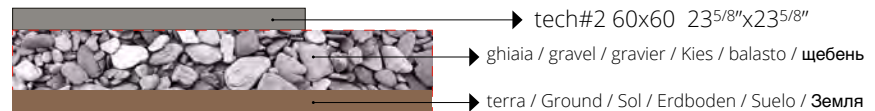

- Posa su massetto cementizio
- Installation on sand-cement screed
- Pose sur chape ciment
- Verlegung auf Zement-Unterbetonblock
- Colocación sobre contrapiso de hormigón
- Укладка на цементную стяжку

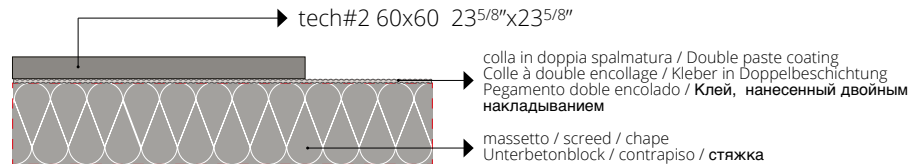

- Posa su piedini fissi o regolabili
- Installation on fixed or adjustable feet
- Pose sur pieds fixes ou réglables
- Verlegung auf feststehende oder regulierbare Füße
- Colocación sobre pies fijos o regulables
- Укладка на фиксированных или регулируемых ножках

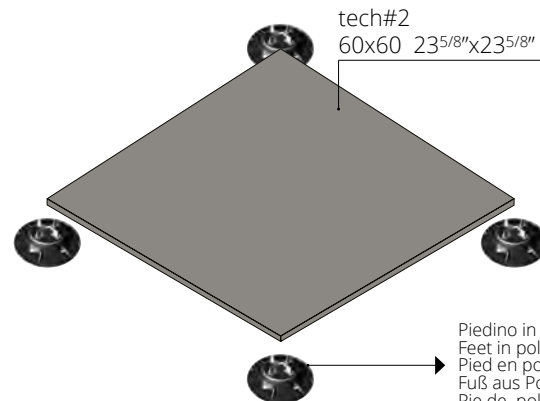

Per le specifiche di utilizzo dei sistemi sopraelevati vedi il sito florim.com
For the specifics on use of raised systems visit the site florim.com
Pour les caractéristiques d'utilisation des systèmes surélevés, voir le site florim.com
Für die Nutzungsbedingungen der Doppelbodensysteme siehe Webseite florim.com
Para las especificaciones de empleo de los sistemas sobreelevados consulte el sitio web florim.com
Технические характеристики систем фальшполов см. на сайте florim.com

Le lastre ceramiche sono sottoposte a un trattamento di compattazione termica che assicura resistenza e durata nel tempo. Il bassissimo assorbimento d'acqua rende perciò il materiale ingelivo. Ciò può comportare ristagni d'acqua superficiali anche per materiale installato a regola d'arte. / Ceramic tiles undergo a compacting thermal treatment that ensures resistance and durability. The low level of water absorption makes the slabs frost resistant. This could result in superficial water stagnations even if materials are installed in a workmanlike manner. / Les carreaux de céramique subissent un traitement thermique qui assure résistance et durabilité. Le bas niveau d'absorption d'eau rend les dalles résistant au gel. Il pourrait en résulter des stagnations d'eau superficielles, même si les dalles ont été installées dans les règles de l'art. / Die Keramikplatten werden einer thermischen Verdichtung unterzogen, welche die Widerstandsfähigkeit und Langlebigkeit sichert. Die extrem niedrige Wasseraufnahme macht das Material frostsicher. Die hohe Materialdichte kann, auch bei einer perfekten Verlegung, eine längere Abtrocknungszeit von angestauntem Wasser zur Folge haben. / Las baldosas cerámicas se someten a un tratamiento de compactación térmica que asegura resistencia y durabilidad. La baja absorción de agua hace que las baldosas resistan al hielo. Esto podría resultar en estancamientos superficiales de agua, incluso si los materiales están instalados según las reglas del arte. / Керамическая плитка подвергается термическому уплотнению, что обеспечивает ей прочность и износостойкость. За счёт очень низкого водопоглощения она не промерзает, при этом даже при правильной укладке возможны застои воды на поверхности плитки.

LIGHT GRAY



GREY

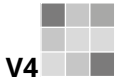
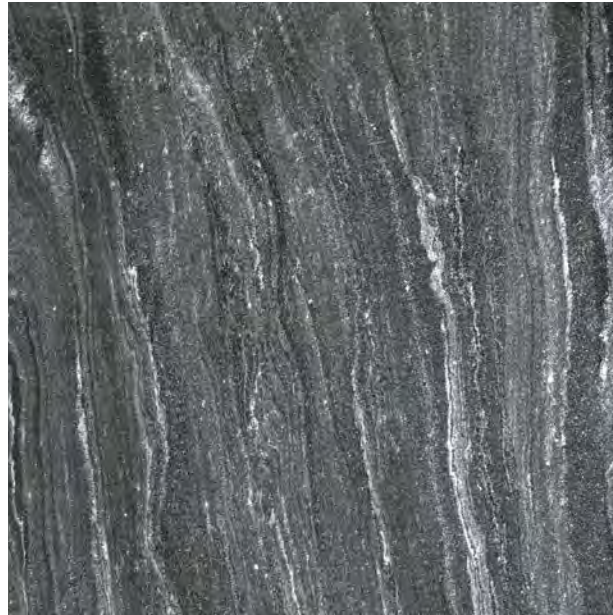

R12
CLASSE C

20 mm 3/4" ↑↓

GRES FINE PORCELLANATO

FINE PORCELAIN STONEWARE/GRES CERAME FIN/FEINSTEINZEUG-KOLLEKTIONEN/GRES PORCELANICO FINO/ФАРФОРОВЫЙ КЕРАМОГРАНИТ
SQUADRATO - SQUARED - EQUARRI - REKTIFIZIERT - ESCUADRADO - КАЛИБРОВАННАЯ

TECH#2	COLOR	SURFACE	40x120 15 ^{3/4"} x47 ^{11/16"}		60x60 23 ^{5/8"} x23 ^{5/8"}	
			740413 ■ FL-10800	740411 ■ FL-07700	740412 ■ FL-10800	740034 ■ FL-07700
	LIGHT GRAY	STRUTTURATO				
	GREY	STRUTTURATO				

PEZZI SPECIALI

Special trims/Pièces spéciales/Formstücke
Piezas especiales/СПЕЦИАЛЬНЫЕ ИЗДЕЛИЯ
pag 166/169



Recycled material content certification

ISO 10545-4	RESISTENZA ALLA FLESSIONE IN N/mm ² N/mm ² FLEXURAL STRENGTH TEST / RESISTANCE A LA FLEXION EN N/mm ² / BIEGEFESTIGKEIT IN N/mm ² / RESISTENCIA A LA FLEXION EN N/mm ² / УСТОЙЧИВОСТЬ К ИЗГИБУ В Н/мм ²	valore medio 52 N/mm ²
	Forza di rottura in N (sp. > 7,5 mm) / Force de rupture en N (sp. > 7,5 mm) / Bruchlast in N (Dicke > 7,5 mm) / Fuerza de rotura en N (gr. > 7,5 mm) / Разрывное усилие, Н (толщ. > 7,5 мм)	valore medio 14000 N

TECH#2	scatola - box			pallet		
	pz	mq	kg	box	mq	kg
40x120 20mm	2	0,96	42,90	24	23,04	1050
60x60 20mm	2	0,72	31,70	30	21,60	980



WALKS/1.0

gres fine porcellanato
fine porcelain stoneware
grès cérame fin
feinsteinzeug-kollektionen
gres porcelánico fino
фарфоровый керамогранит





WALKS/1.0

Walks 1.0 è tecnologia e natura, unite in modo esatto e incisivo. Precisione estetica, rigore e pulizia formale contraddistinguono le scelte cromatiche che caratterizzano la serie accentuando la sua semplicità non convenzionale. Disponibile in due finiture, soft e naturale, è perfetta per interpretare architetture di interni e spazi esterni che dialogano con il paesaggio circostante. Un design dal linguaggio internazionale, accattivante e senza tempo.

Walks 1.0 is technology and nature, precisely and incisively joint. Aesthetical precision, rigour and formal cleaning distinguish the colour choices that characterise the series, accentuating its unconventional simplicity. Available in two finishes, soft and natural, it is perfect for interpreting indoor architecture and outdoor spaces that converse with the surrounding setting. A design with international language, catchy and timeless.

Walks 1.0 est la technologie et la nature qui s'unissent parfaitement de manière incisive. Précision esthétique, rigueur et netteté formelle distinguent les choix des teintes qui caractérisent la série en accentuant sa simplicité non conventionnelle. Disponible en deux finitions, soft et naturelle, elle s'adapte parfaitement à l'interprétation d'architectures d'intérieurs et d'espaces extérieurs qui dialoguent avec le paysage qui les entoure. Un design avec un langage International, captivant et intemporel.

Walks 1.0 ist auf exakte und einprägsame Art mit Natur vereinte Technologie. Ästhetische Präzision, Strenge und Reinheit der Formen zeichnen die Farbwahl der Serie aus und betonen deren unkonventionelle Einfachheit. Sie ist in den zwei Endbearbeitungen, Soft und Natürlich, erhältlich und eignet sich perfekt dazu, Innenarchitekturen und Außenflächen in Harmonie mit der umliegenden Landschaft zu interpretieren. Ein Design mit internationalem, ansprechendem und zeitlosen Flair.

Walks 1.0 es tecnología y naturaleza, unidas en un modo exacto e incisivo. Precisión estética, rigor y limpieza formal contradistinguen las elecciones cromáticas que caracterizan la serie, acentuando su sencillez no convencional. Disponible en dos acabados, soft y natural, es perfecta para interpretar arquitecturas de interiores y exteriores, que dialogan con el paisaje alrededor. Un diseño con un lenguaje internacional, cautivador y sin tiempo.

Walks 1.0 – это технология и природа, которые были объединены точным и верным способом. Внешняя точность, строгость и чистота отличают цветовой выбор, который характеризует серию, подчёркивая её нетрадиционную простоту. Имеется в наличии с двумя отделками: мягкая и натуральная; прекрасно подходит для внутренних структур и внешних пространств, которые взаимодействуют с окружающим пейзажем. Всегда современный и привлекательный дизайн, который понятен во всём мире.

WALKS/1.0

WHITE



GRAY

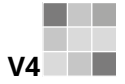

V4

R11
Classe C
(naturale)

R9
(soft)



DCOF>
0,42 Wet

10 mm 3/8" ↓

GRES FINE PORCELLANATO

FINE PORCELAIN STONEWARE / GRÈS CÉRAME FIN / FEINSTEINZEUG-KOLLEKTIONEN / GRES PORCELÁNICO FINO / фарфоровый керамогранит

SQUADRATO - SQUARED - EQUARRI - REKTIFIZIERT - ESCUADRADO - КАЛИБРОВАННА

10 mm 3/8" ↓		COLOR	SURFACE	60x120 23 ^{5/8"} x47 ^{1/4"}	40x80 15 ^{3/4"} x31 ^{1/2"}	60x60 23 ^{5/8"} x23 ^{5/8"}	30x60 11 ^{4/5"} x23 ^{5/8"}
WALKS/1.0		WHITE	NATURALE	742827 ■ FL-09300	728722 ■ FL-06700	728746 ■ FL-06700	728755 ■ FL-05800
			SOFT	742831 ■ FL-09300	728726 ■ FL-06700	728750 ■ FL-06700	728759 ■ FL-05800
		GRAY	NATURALE	742828 ■ FL-09300	728723 ■ FL-06700	728747 ■ FL-06700	728756 ■ FL-05800
			SOFT	742832 ■ FL-09300	728727 ■ FL-06700	728752 ■ FL-06700	728760 ■ FL-05800

BEIGE



BLACK

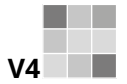

V4

R11
Classe C
(naturale)



R9
(soft)

DCOF >
0,42 Wet







10 mm 3/8" ↑↓

GRES FINE PORCELLANATO







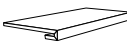

FINE PORCELAIN STONEWARE / GRÈS CÉRAME FIN / FEINSTEINZEUG-KOLLEKTIONEN / GRES PORCELÁNICO FINO / фарфоровый керамогранит
SQUADRATO - SQUARED - EQUARRI - REKTIFIZIERT - ESCUADRADO - КАЛИБРОВАННА

10 mm 3/8" ↑↓		COLOR	SURFACE	60x120 23 ^{5/8"} x47 ^{1/4"}	40x80 15 ^{3/4"} x31 ^{1/2"}	60x60 23 ^{5/8"} x23 ^{5/8"}	30x60 11 ^{4/5"} x23 ^{5/8"}	
WALKS/1.0		BEIGE	NATURALE	742829 ■ FL-09300	728724 ■ FL-06700	728748 ■ FL-06700	728757 ■ FL-05800	
			SOFT	742833 ■ FL-09300	728728 ■ FL-06700	728753 ■ FL-06700	728761 ■ FL-05800	
			BLACK	NATURALE	742830 ■ FL-09300	728725 ■ FL-06700	728749 ■ FL-06700	728758 ■ FL-05800
				SOFT	742834 ■ FL-09300	728729 ■ FL-06700	728754 ■ FL-06700	728762 ■ FL-05800

WALKS/1.0

10 mm 3/8" ↑↓		COLOR	SURFACE	30x30 11 4/5"x11 4/5"  mosaico tessere 3x3	21x40 8 1/4"x15 3/4"  modulo listello sfalsato
WALKS/1.0		WHITE	NATURALE	728797 ■ FL-14000	728780 ■ FL-17200
			SOFT	-	729495 ■ FL-17200
		GRAY	NATURALE	728799 ■ FL-14000	728782 ■ FL-17200
			SOFT	-	729498 ■ FL-17200
		BEIGE	NATURALE	728798 ■ FL-14000	728781 ■ FL-17200
			SOFT	-	729496 ■ FL-17200
		BLACK	NATURALE	728800 ■ FL-14000	728783 ■ FL-17200
			SOFT	-	729500 ■ FL-17200

PEZZI SPECIALI/SPECIAL TRIMS/PIÈCES SPÉCIALES/FORMSTÜCKE/PIEZAS ESPECIALES/Специальные изделия

10 mm 3/8" ↑↓		COLOR	SURFACE	4,6x60 1 4/5"x23 5/8"  battiscopa	33x60x3 13"x23 5/8"x1 1/8"  gradino pz/box 4	33x33x3 13"x13"x1 1/8"  angolo gradino pz/box 2	20x30x6 7 7/8"x11 4/5"x2 1/8"  elemento elle pz/box 6	1x20 2/5"x7 7/8"  quarter round pz/box 12	1x21 2/5"x8 1/4"  angolo quarter round pz/box 4
WALKS/1.0		WHITE	NATURALE	-	728784 ▲ FL-09300	728788 ▲ FL-10500	728801 ▲ FL-01700	728831 ▲ FL-01160	728835 ▲ FL-01700
			SOFT	745559 ◆ FL-01600	-	-	-	-	-
		GRAY	NATURALE	-	728786 ▲ FL-09300	728791 ▲ FL-10500	728805 ▲ FL-01700	728833 ▲ FL-01160	728837 ▲ FL-01700
			SOFT	745561 ◆ FL-01600	-	-	-	-	-
		BEIGE	NATURALE	-	728785 ▲ FL-09300	728790 ▲ FL-10500	728804 ▲ FL-01700	728832 ▲ FL-01160	728836 ▲ FL-01700
			SOFT	745560 ◆ FL-01600	-	-	-	-	-
		BLACK	NATURALE	-	728787 ▲ FL-09300	728792 ▲ FL-10500	728806 ▲ FL-01700	728834 ▲ FL-01160	728838 ▲ FL-01700
			SOFT	745562 ◆ FL-01600	-	-	-	-	-

WALKS/1.0	scatola - box			pallet		
	pz	mq	kg	box	mq	kg
60x120	2	1,44	30,20	30	43,20	930
40x80	3	0,96	22,00	56	53,76	1260
60x60	3	1,08	24,20	40	43,20	990
30x60	6	1,08	24,20	40	43,20	990
21x40 mod. list. sfalsato	5	0,42	8,40	40	16,80	360
30x30 mosaico	11	1,00	20,00	30	30,00	630

WALKS/1.0	scatola - box			pallet		
	pz	ml	kg	box	mq	kg
4,6x60 battiscopa	14	8,40	8,40	-	-	-

Per un effetto ottimale della posa, florim suggerisce di mantenere 2 mm di fuga per pose monoformato e 3 mm per combinare formati misti - For optimal installation results, florim recommends maintaining a joint of 2 mm 1/16" for single format installations and 3 mm 1/8" to combine mixed formats. - Pour réaliser une pose parfaite, florim suggère de maintenir 2 mm de joint pour la pose des monoformats, et 3 mm pour les combinaisons de formats mixtes. - Um einen optimalen effekt beim verlegen zu erzielen empfiehlt florim eine 2 mm fugе bei einformatigen verlegungen und 3 mm fugе bei formatkombinationen. Para lograr los máximos resultados en la posa del producto, florim aconseja 2 mm de junta en aplicaciones monoformato y 3 mm en combinaciones de formatos mixtos. - ДЛЯ ОПТИМАЛЬНОЙ УКЛАДКИ « FLORIM » РЕКОМЕНДУЕТ ВЫДЕРЖИВАТЬ ЗАЗОР 2 ММ ДЛЯ МОНОФОРМАТА И 3 ММ ПРИ СМЕШАННЫХ ФОРМАТАХ.



WALKS/1.0 OUTDOOR

Vantaggi tecnici - Technical advantages - Avantages techniques Technische Vorteile - Ventajas técnicas - Технические преимущества

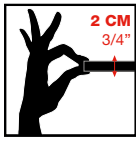

- Lastra monolitica compatta di spessore 2 cm squadrata e rettificata
- Compact monolithic slab 2 cm thick squared and rectified
- Dalle monolithique compacte de 2 cm d'épaisseur, équaree et rectifiée
- Kompakte monolithische Platte, 2 cm dick, rechteckig und scharfkantig geschliffen
- Losa monolítica compacta de 2 cm de espesor, escuadrada y rectificada.
- Монолитная плотная плита толщиной 2 см, с обрезанными и выровненными кромками

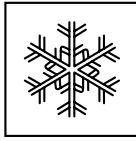

- INGELIVO
- FROST RESISTANT
- INGÉLIF
- FROSTBESTÄNDIG
- RESISTENTE A LA HELADA
- МОРОЗОСТОЙКАЯ

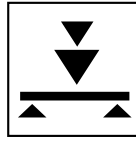

- ELEVATA RESISTENZA AI CARICHI STATICI
- HIGH STATIC LOAD RESISTANCE
- RÉSISTANCE ÉLEVÉE AUX CHARGES STATIQUES
- HOHE STATISCHE BELASTBARKEIT
- ELEVADA RESISTENCIA A LAS CARGAS ESTÁTICAS
- ВЫДЕРЖИВАЕТ БОЛЬШИЕ СТАТИЧЕСКИЕ НАГРУЗКИ

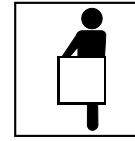

- FACILE DA POSARE
- EASY TO INSTALL
- FACILE À POSER
- VERLEGELEICHT
- FÁCIL DE COLOCAR
- ЛЕГКО УКЛАДЫВАЕТСЯ



- ANTISCIVOLO R11
- ANTI SLIP R11
- ANTIDÉRAPANT R11
- RUTSCHFEST R11
- ANTIDESLIZANTE R11
- НЕСКОЛЬЗКАЯ - R11

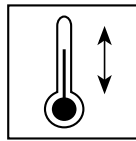

- RESISTENTE AGLI SBALZI TERMICI
- THERMAL SHOCK RESISTANT
- RÉSISTANT AUX ÉCARTS THERMIQUES
- TEMPERATURWECHSELBESTÄNDIG
- RESISTENTE A LAS OSCILACIONES TÉRMICAS
- СТОЙКАЯ К ТЕПЛОВЫМ ПЕРЕПАДАМ



- FACILE DA PULIRE
- EASY TO CLEAN
- FACILE À NETTOYER
- REINIGUNGSLEICHT
- FÁCIL DE LIMPIAR
- ЛЕГКО ЧИСТИТСЯ

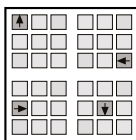

- RIMOVIBILE E RIUTILIZZABILE
- REMOVABLE AND REUSABLE
- DÉMONTABLE ET RÉUTILISABLE
- ENTFERNBAR UND WIEDERVERWENDBAR
- DESMONTABLE Y REUTILIZABLE
- МОЖЕТ СНИМАТЬСЯ И ПОВТОРНО ИСПОЛЬЗОВАТЬСЯ



- INATTACCABILE DA AGENTI CHIMICI E MUFFE
- IMPERVIUS TO ATTACK BY CHEMICALS OR MOULD
- RÉSISTANT AUX AGENTS CHIMIQUES ET AUX MOISSISSURES
- UNANGREIFBAR DURCH CHEMISCHE STOFFE UND SCHIMMEL
- RESISTENTE A LOS AGENTES QUÍMICOS Y A LOS MOHOS
- НЕ ПОДВЕРГАЕТСЯ ВОЗДЕЙСТВИЮ ХИМИЧЕСКИХ ВЕЩЕСТВ И ПЛЕСЕНИ

Applicazioni - Applications - Applications - Verlegung - Aplicaciones - Применения

- Posa diretta su erba
- Direct installation on grass
- Pose direct sur de l'herbe
- Verlegung direkt auf Rasen
- Colocación directa sobre hierba
- Прямая укладка на траву

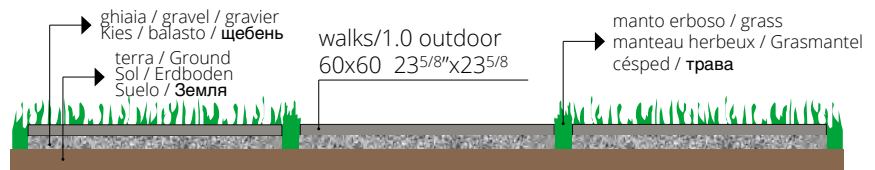

- Posa diretta su ghiaia
- Direct installation over gravel
- Pose direct sur du gravier
- Verlegung direkt auf Kies
- Colocación directa sobre grava
- Прямая укладка на гальку



- Posa su massetto cementizio
- Installation on sand-cement screed
- Pose sur chape ciment
- Verlegung auf Zement-Unterbetonblock
- Colocación sobre contrapiso de hormigón
- Укладка на цементную стяжку

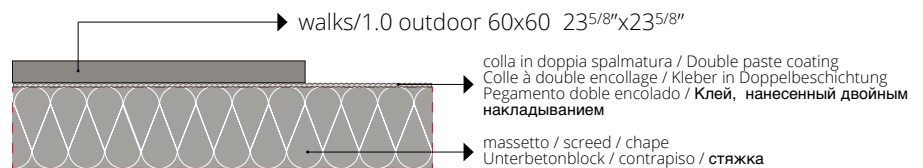

- Posa su piedini fissi o regolabili
- Installation on fixed or adjustable feet
- Pose sur pieds fixes ou réglables
- Verlegung auf feststehende oder regulierbare Füße
- Colocación sobre pies fijos o regulables
- Укладка на фиксированных или регулируемых ножках

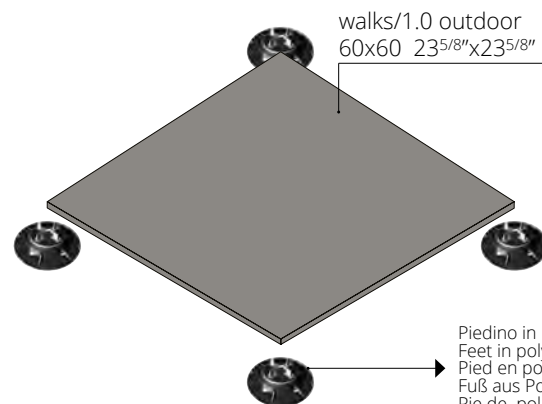

Per le specifiche di utilizzo dei sistemi sopraelevati vedi il sito florim.com
For the specifics on use of raised systems visit the site florim.com
Pour les caractéristiques d'utilisation des systèmes surélevés, voir le site florim.com
Für die Nutzungsbedingungen der Doppelbodensysteme siehe Webseite florim.com
Para las especificaciones de empleo de los sistemas sobreelevados consulte el sitio web florim.com
Технические характеристики систем фальшполов см. на сайте florim.com

Le lastre ceramiche sono sottoposte a un trattamento di compattazione termica che assicura resistenza e durata nel tempo. Il bassissimo assorbimento d'acqua rende perciò il materiale ingelivo. Ciò può comportare ristagni d'acqua superficiali anche per materiale installato a regola d'arte. / Ceramic tiles undergo a compacting thermal treatment that ensures resistance and durability. The low level of water absorption makes the slabs frost resistant. This could result in superficial water stagnations even if materials are installed in a workmanlike manner. / Les carreaux de céramique subissent un traitement thermique qui assure résistance et durabilité. Le bas niveau d'absorption d'eau rend les dalles résistant au gel. Il pourrait en résulter des stagnations d'eau superficielles, même si les dalles ont été installées dans les règles de l'art. / Die Keramikplatten werden einer thermischen Verdichtung unterzogen, welche die Widerstandsfähigkeit und Langlebigkeit sichert. Die extrem niedrige Wasseraufnahme macht das Material frostsicher. Die hohe Materialdichte kann, auch bei einer perfekten Verlegung, eine längere Abtrocknungszeit von angestauntem Wasser zur Folge haben. / Las baldosas cerámicas se someten a un tratamiento de compactación térmica que asegura resistencia y durabilidad. La baja absorción de agua hace que las baldosas resistan al hielo. Esto podría resultar en estancamientos superficiales de agua, incluso si los materiales están instalados según las reglas del arte. / Керамическая плитка подвергается термическому уплотнению, что обеспечивает ей прочность и износостойкость. За счёт очень низкого водопоглощения она не промерзает, при этом даже при правильной укладке возможны застои воды на поверхности плитки.

WHITE



GRAY



V4

R11

20 mm 3/4" ↑↓

GRES FINE PORCELLANATO

FINE PORCELAIN STONEWARE/GRES CERAME FIN/FEINSTEINZEUG-KOLLEKTIONEN/GRES PORCELANICO FINO/ФАРФОРОВЫЙ КЕРАМОГРАНИТ
SQUADRATO - SQUARED - EQUARRI - REKTIFIZIERT - ESCUADRADO - КАЛИБРОВАННАЯ

WALKS/1.0	20 mm 3/4" ↑↓	COLOR	SURFACE	40x120	60x60
				15 ^{3/4"} x47 ^{1/4"}	23 ^{5/8"} x23 ^{5/8"}
		WHITE	NATURALE	740560 ■ FL-12400	740558 ■ FL-09300
		GRAY	NATURALE	740561 ■ FL-12400	740559 ■ FL-09300

PEZZI SPECIALI

Special trims/Pièces spéciales/Formstücke
Piezas especiales/СПЕЦИАЛЬНЫЕ ИЗДЕЛИЯ
pag 166/169

	RESISTENZA ALLA FLESSIONE IN N/mm ² N/mm ² FLEXURAL STRENGTH TEST / RESISTANCE A LA FLEXION EN N/mm ² / BIEGEFESTIGKEIT IN N/mm ² / RESISTENCIA A LA FLEXION EN N/mm ² / УСТОЙЧИВОСТЬ К ИЗГИБУ В Н/мм ²	valore medio 52 N/mm ²
	Forza di rottura in N (sp. > 7,5 mm) Breaking strength in N (thickness > 7,5 mm) / Force de rupture en N (ép. > 7,5 mm) / Bruchlast in N (Dicke > 7,5 mm) / Fuerza de rotura en N (gr. > 7,5 mm) / Разрывное усилие, Н (толщ. > 7,5 мм)	valore medio 14000 N

WALKS/1.0	scatola - box			pallet		
	pz	mq	kg	box	mq	kg
40x120 20mm	2	0,96	42,90	24	23,04	1050
60x60 20mm	2	0,72	32,10	30	21,60	990

OUTDOOR 20mm PEZZI SPECIALI

SPECIAL TRIMS

PIÈCES SPÉCIALES

FORMSTÜCKE

PIEZAS ESPECIALES

СПЕЦИАЛЬНЫЕ ИЗДЕЛИЯ



CARATTERISTICHE TECNICHE



TECHNICAL FEATURES
CARACTÉRISTIQUES TECHNIQUES
TECHNISCHE EIGENSCHAFTEN
CARACTERÍSTICAS TÉCNICAS
ТЕХНИЧЕСКИЕ ХАРАКТЕРИСТИКИ

Pezzi speciali Outdoor 20mm

Special trims/Pièces spéciales/Formstücke / Piezas especiales/СПЕЦИАЛЬНЫЕ ИЗДЕЛИЯ

Collections:

AIRTECH - BUILDTECH/2.0 - EARTHECH - INDUSTRIAL
STONTECH/4.0 - RAWTECH - TECH#2 CM - WALKS/1.0

Collections:

AIRTECH - BUILDTECH/2.0 - EARTHECH
STONTECH/4.0 - RAWTECH - TECH#2 CM

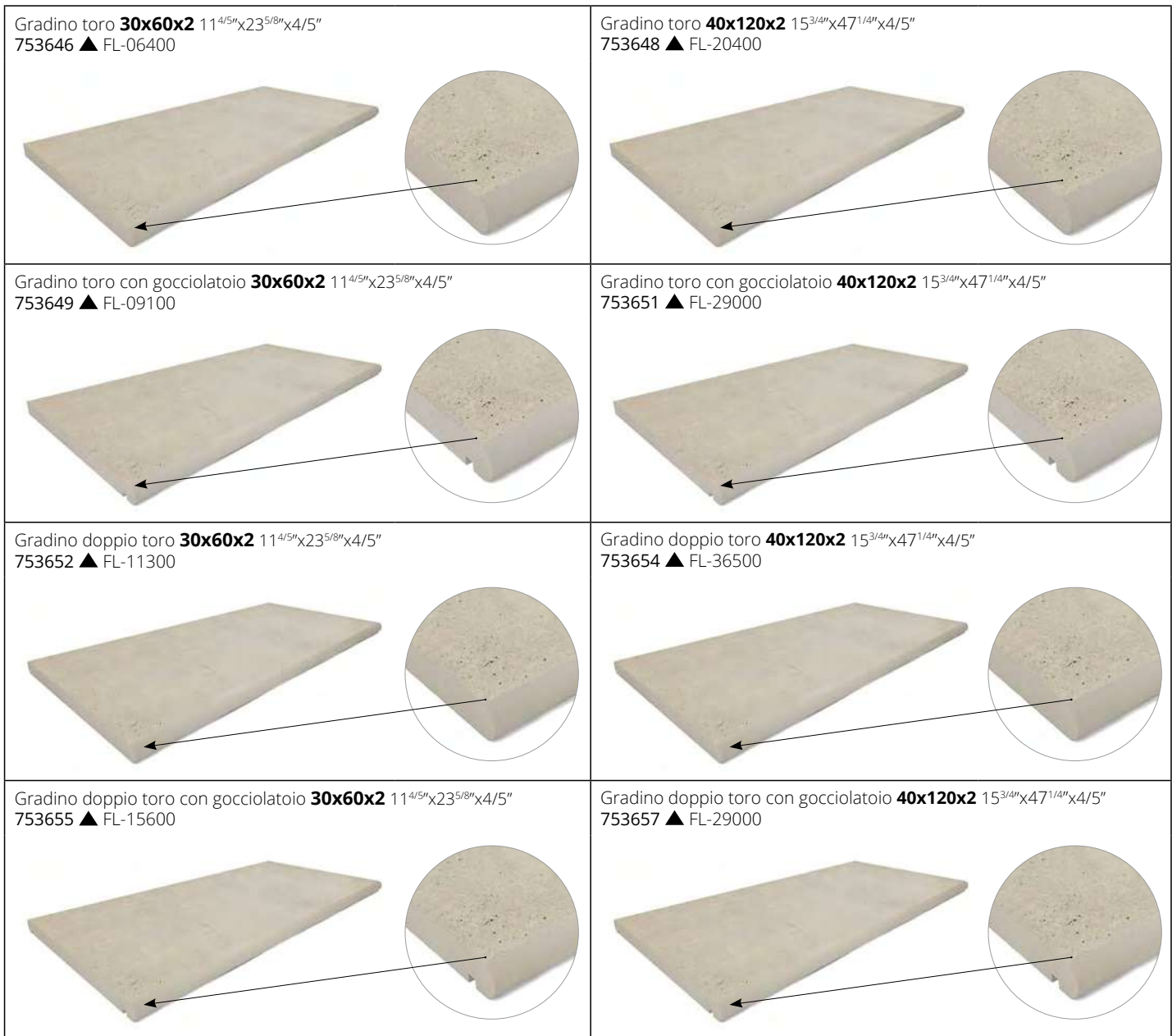

PEZZI SPECIALI OUTDOOR 20mm	scatola - box			pallet		
	pz	mq	kg	box	mq	kg
30x60 gradino toro	1	-	10,00	-	-	-
30x60 gradino toro con gocciolatoio	1	-	10,00	-	-	-
30x60 gradino doppio toro	1	-	10,00	-	-	-
30x60 gradino doppio toro con gocciolatoio	1	-	10,00	-	-	-
40x120 gradino toro	1	-	25,00	-	-	-
40x120 gradino toro con gocciolatoio	1	-	25,00	-	-	-
40x120 gradino doppio toro con gocciolatoio	1	-	25,00	-	-	-
30x60 elemento ad elle	1	-	10,00	-	-	-
30x60 elemento ad elle angolo dx/sx	1	-	10,00	-	-	-
60x60 elemento ad elle	1	-	20,00	-	-	-
60x60 elemento ad elle angolo dx/sx	1	-	20,00	-	-	-
40x120 elemento ad elle	1	-	25,00	-	-	-
40x120 elemento ad elle angolo dx/sx	1	-	25,00	-	-	-

Collections:

AIRTECH - BUILDTECH/2.0 - EARTHECH - INDUSTRIAL
 STONTECH/4.0 - RAWTECH - TECH#2 CM - WALKS/1.0

Collections:

AIRTECH - BUILDTECH/2.0 - EARTHECH
 STONTECH/4.0 - RAWTECH - TECH#2 CM

Elemento ad Elle Angolo SX **30x60x8** 11^{4/5"}x23^{5/8"}x3^{1/8"}
 753852 ▲ FL-14500



Elemento ad Elle Angolo SX **40x120x8** 15^{3/4"}x47^{1/4"}x3^{1/8"}
 753861 ▲ FL-29000

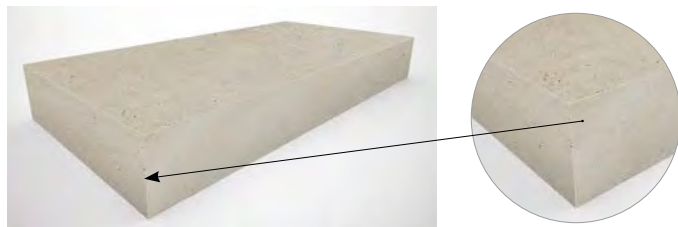

Elemento ad Elle **30x60x8** 11^{4/5"}x23^{5/8"}x3^{1/8"}
 753850 ▲ FL-09300

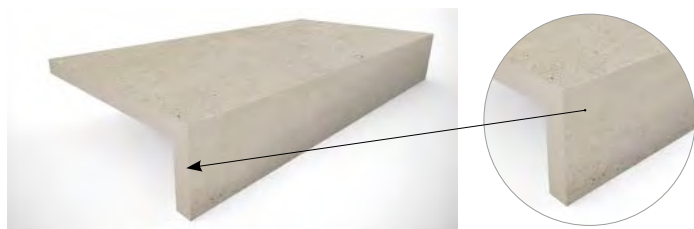

Elemento ad Elle **40x120x8** 15^{3/4"}x47^{1/4"}x3^{1/8"}
 753859 ▲ FL-19900

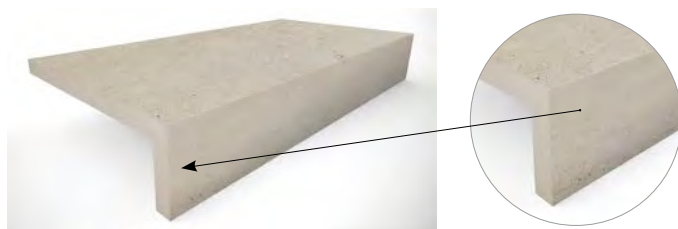

Elemento ad Elle Angolo DX **30x60x8** 11^{4/5"}x23^{5/8"}x3^{1/8"}
 753851 ▲ FL-14500

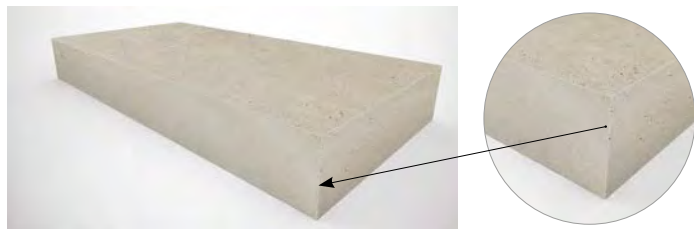

Elemento ad Elle Angolo DX **40x120x8** 15^{3/4"}x47^{1/4"}x3^{1/8"}
 753860 ▲ FL-29000

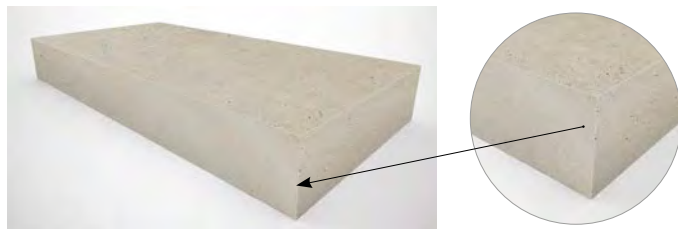

Elemento ad Elle Angolo SX **60x60x8** 23^{5/8"}x23^{5/8"}x3^{1/8"}
 753855 ▲ FL-19900



Pezzi speciali e fondo possono differire in termini di tonalità, il bordo può presentare stratificazioni di tonalità diverse.

Special pieces and field tiles may come in different shades, the slab's edge may show layers of differing hues.

Il peut y avoir des différences de tonalités entre les pièces spéciales et le fond, le bord pourrait présenter des stratifications de tonalités différentes.

Die Formteile können farblich von der Grundplatte abweichen, ihre Kanten können Schichtungen in unterschiedlichen Farbtönen aufweisen.

Piezas especiales y bases pueden diferir en términos de tonalidad, el borde puede presentar estratificaciones de diferente tonalidad.

Специальные элементы и фоновый материал могут отличаться по тону, край может иметь несколько слоев оттенков.

Elemento ad Elle **60x60x8** 23^{5/8"}x23^{5/8"}x3^{1/8"}
 753853 ▲ FL-14000

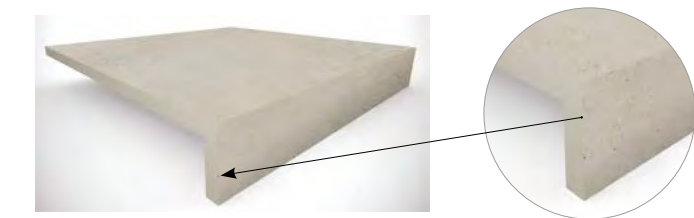

Elemento ad Elle Angolo DX **60x60x8** 23^{5/8"}x23^{5/8"}x3^{1/8"}
 753854 ▲ FL-19900



BORDO VASCA

SWIMMING POOL EDGE

BORD DE PISCINE

BECKENRAND

BORDE DE LA TINA

НРАЯ БАСЕЙНА

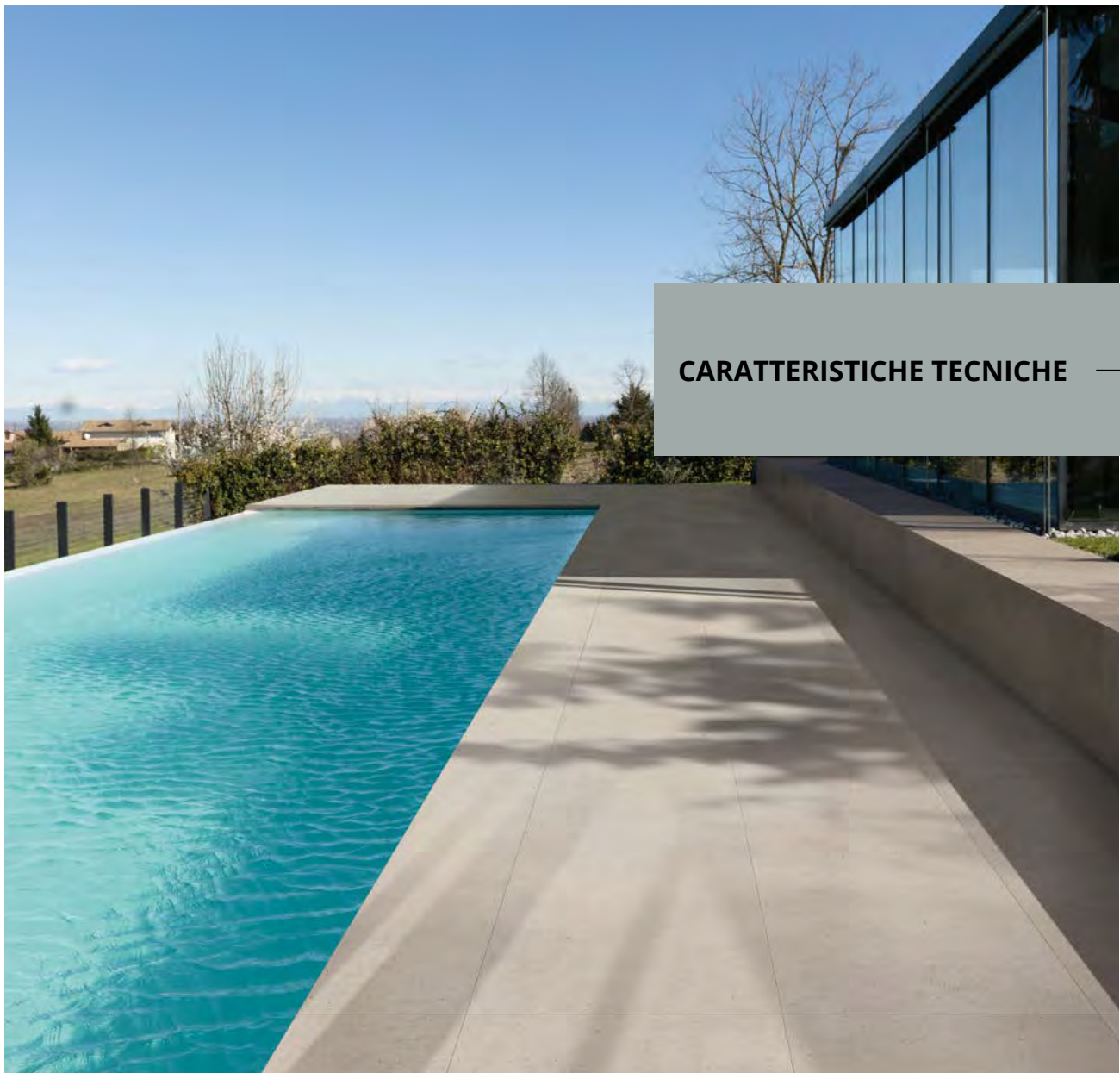

CARATTERISTICHE TECNICHE



TECHNICAL FEATURES
CARACTÉRISTIQUES TECHNIQUES
TECHNISCHE EIGENSCHAFTEN
CARACTERÍSTICAS TÉCNICAS
ТЕХНИЧЕСКИЕ ХАРАКТЕРИСТИКИ

WAVE/SPECIALPIECES

BORDO VASCA / SWIMMING POOL EDGE / BORD DE PISCINE
BECKENRAND / BORDE DE LA TINA / ПРЯЯ БАССЕЙНА

WAVE LINEARE



30,5x60 12"x23^{5/8}"

762862

▲ FL-13400

40,5x80 16"x31^{1/2}"

769298

▲ FL-21000

WAVE ANGOLO AE



30,5x30,5 12"x12"

762872

▲ FL-19400

40,5x40,5 16"x16"

769302

▲ FL-27900

WAVE ANGOLO AI 45°



30,5x60x60 12"x23^{5/8}"x23^{5/8}"

762867

▲ FL-29000

40,5x80x80 12"x31^{1/2}"x31^{1/2}"

769303

▲ FL-44100

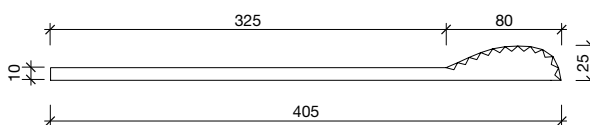
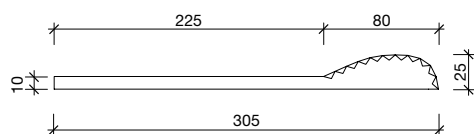

BORDO PER PISCINA "WAVE"

Rivoluzionario pezzo speciale che, attraverso l'accostamento di una serie di listelli opportunamente conformati su un lato del pezzo, rende ottimale la trascinazione, il contenimento dell'acqua, nonché l'appiglio manuale. La flessibilità progettuale di questo pezzo consente di realizzare bordi con diversi materiali Florim selezionati tra le serie che presentano le più elevate proprietà antiscivolo a piedi nudi (classe A+B+C, rif. norma DIN 51097).

"WAVE" SWIMMING POOL EDGE

Revolutionary border tile that, by placing together a set of suitably shaped strips on one side of the tile, makes an efficient overflow, containing the water and also offering a hand-grip. The flexibility of the design of this tile enables edges to be created with different Florim materials selected from the ranges that have the highest barefoot slip-resistance ratings (Class A+B+C, according to DIN 51097 standard).

BORD POUR PISCINE « WAVE »

Pièce spéciale révolutionnaire qui, grâce à la juxtaposition d'une série de listels dûment disposés sur un côté de la pièce, optimise le débordement, le confinement de l'eau, ainsi que le point d'accroche avec les mains. La flexibilité de conception de cette pièce permet de réaliser des bords avec différents matériaux Florim sélectionnés parmi les séries dotées des plus hautes propriétés antidérapantes pieds nus (classe A+B+C, réf. norme DIN 51097).

BECKENRANDSTEIN "WAVE"

Ein revolutionäres Spezialteil, das durch das Aneinandersetzen einer Reihe von Leisten, die an einer Seite des Spezialteils zweckmäßig geformt sind, eine ausgezeichnete Überflutung, Wassereindämmung und Griffkante bietet. Die flexible Projektanpassung dieses Spezialteils erlaubt die Gestaltung von Beckenrändern mit verschiedenen Florim-Materialien, ausgewählt unter den Produktserien mit der höchsten Barfuß-Rutschfestigkeit (Klasse A+B+C, Bezugsnorm DIN 51097).

BORDE PARA PISCINA «WAVE»

Pieza especial revolucionaria que se remata por un lado con una serie de listones de forma especial, para ofrecer un desbordamiento y retención del agua óptimos, así como un excelente asidero manual. La flexibilidad de diseño de esta pieza permite realizar bordes con varios materiales de Florim, seleccionados entre las series que presentan las más altas propiedades antideslizantes con pies descalzos (clase A+B+C, ref. norma DIN 51097).

БОРТ ДЛЯ БАССЕЙНА "WAVE"

Революционно новое специальное изделие, которое благодаря совмещению по одной стороне изделия ряда реек особенной формы, обеспечивает оптимальный перелив, удержание воды, а также захват для рук. Дизайнерская универсальность этого изделия позволяет выполнять борты из разнообразных материалов Florim, выбираемых из тех серий, которые обладают самыми высокими характеристиками нескользкости для босых ног (класс A+B+C, стандарт DIN 51097).

OCEAN/SPECIALPIECES

BORDO VASCA / SWIMMING POOL EDGE / BORD DE PISCINE
BECKENRAND / BORDE DE LA TINA / ПРЯЯ БАССЕЙНА

OCEAN LINEARE



32x60 12^{3/5}"x23^{5/8}"

762877

▲ FL-16700

OCEAN ANGOLO AE



30,5x30,5 12"x12"

762887

▲ FL-19400

OCEAN ANGOLO AI 45°



32x60x60 12^{3/5}"x23^{5/8}"x23^{5/8}"

762882

▲ FL-36500

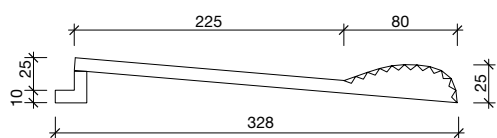

BORDO PER PISCINA "OCEAN"

Innovativo e rivoluzionario pezzo speciale progettato appositamente per essere utilizzato come bordo piscina con sistema ad acqua traboccante a sfioro. E' composto da un pezzo che, attraverso l'accostamento di una serie di listelli opportunamente conformati su un lato del pezzo, rende ottimale la trascinazione, il contenimento dell'acqua, nonché l'appiglio manuale. La flessibilità progettuale di questo pezzo consente di realizzare bordi con diversi materiali Florim selezionati tra le serie che presentano le più elevate proprietà antiscivolo a piedi nudi (classe A+B+C, rif. norma DIN 51097). Questo pezzo speciale comprende anche l'angolare in porcellanato per appoggio e contenimento griglia.

"OCEAN" SWIMMING POOL EDGE

Innovative, revolutionary border tile specially designed to be used as a swimming pool edge with overflow system. It comprises a piece that, by placing together a set of suitably shaped strips on one side of the tile, makes an efficient overflow, containing the water and also offering a hand-grip. The flexibility of the design of this tile enables edges with different Florim materials to be created, selecting them from the ranges that have the highest barefoot slip-resistance ratings (Class A+B+C, according to DIN 51097 standard). This special piece also includes the porcelain stoneware corner element for setting and containing the grating.

BORD POUR PISCINE « OCEAN »

Pièce spéciale innovante et révolutionnaire spécialement conçue pour être utilisée comme bord de piscine à débordement avec système de trop-plein. Grâce à la juxtaposition d'une série de listels dûment disposés sur un de ses côtés, cette pièce, optimise le débordement, le confinement de l'eau, ainsi que le point d'accroche avec les mains. La flexibilité de conception de cette pièce permet de réaliser des bords avec différents matériaux Florim sélectionnés parmi les séries dotées des plus hautes propriétés antidérapantes pieds nus (classe A+B+C, réf. norme DIN 51097). Cette pièce spéciale comprend également une pièce d'angle en grès cérame pour le support et le confinement de la grille.

BECKENRANDSTEIN "OCEAN"

Dieses innovative und revolutionäre Spezialteil wurde speziell für die Verwendung als Rand für Schwimmbecken mit Wasserüberlauftrinne entwickelt. Es besteht aus einem Teil, das durch das Aneinandersetzen einer Reihe von Leisten, die an einer Seite des Teils zweckmäßig geformt sind, eine ausgezeichnete Überflutung, Wassereindämmung und Griffkante bietet. Die flexible Projektanpassung dieses Spezialteils erlaubt die Gestaltung von Beckenrändern mit verschiedenen Florim-Materialien, ausgewählt unter den Produktserien mit der höchsten Barfuß-Rutschfestigkeit (Klasse A+B+C, Bezugsnorm DIN 51097). Dieses Spezialteil enthält auch das Eckstück aus Feinsteinzeug zur Aufnahme des Rostes.

BORDE PARA PISCINA «OCEAN»

Pieza especial, innovadora y revolucionaria, diseñada específicamente para usarse como borde de piscina con sistema de agua desbordante. Consta de una pieza que se remata por un lado con una serie de listones de forma especial, para ofrecer un desbordamiento y retención del agua óptimos, así como un excelente asidero manual. La flexibilidad de diseño de esta pieza permite realizar bordes con varios materiales de Florim, seleccionados entre las series que presentan las más altas propiedades antideslizantes con pies descalzos (clase A+B+C, ref. norma DIN 51097). Esta pieza especial también incluye la pieza angular de porcelánico de apoyo y sujeción de la rejilla.

БОРТ ДЛЯ БАССЕЙНА "OCEAN"

Иновационное и революционно новое специальное изделие, спроектированное специально для его использования в качестве борта бассейна с системой перелива. Оно состоит из детали, которая при совмещении с рядом реек особенной формы по одной стороне детали обеспечивает оптимальный перелив, удержание воды, а также захват для рук. Дизайнерская универсальность этого изделия позволяет выполнять борты из разнообразных материалов Florim, выбираемых из тех серий, которые обладают самыми высокими характеристиками нескользкости для босых ног (класс A+B+C, стандарт DIN 51097). Это специальное изделие включает в себя уголок из керамогранита для укладки и удержания решетки.

CARATTERISTICHE - VANTAGGI TECNICI

1. Modularità a base 60/80 cm (in base alla collezione scelta).
2. Facilità di posa, con collanti di normale uso per la ceramica.
3. Elevata leggerezza.
4. Alta resistenza meccanica ai carichi.
5. Sicurezza allo scivolamento.
6. Costanza e precisione dimensionale.
7. Ergonomia che facilita l'appiglio manuale.
8. Conformazione che ottimizza la tracimazione e il contenimento dell'acqua.
9. Massima igiene.
10. Totale impermeabilità.
11. Possibilità di realizzazione con diverse collezioni antiscivolo Florim.
12. Ridotta incidenza nel costo complessivo della vasca.
13. Il taglio dei pezzi in cantiere, deve essere fatto con sistemi adeguati (es. taglio ad acqua con disco diamantato).

TAGLI

E' possibile fornire pezzi tagliati a misura di varie forme e dimensioni. Prezzi e condizioni di vendita sono da stabilire, con specifica offerta da parte della divisione "FLORIM SOLUTIONS".

CARACTÉRISTIQUES - AVANTAGES TECHNIQUES

1. Modularité à la base 60/ 80 cm (en fonction de la collection choisie)
2. Facilité de pose, avec des adhésifs à usage normal pour la céramique.
3. Légèreté élevée.
4. Haute résistance mécanique aux charges.
5. Antidérapant.
6. Constance et précision dimensionnelles.
7. Ergonomie qui facilite la prise manuelle.
8. Conformation qui optimise le débordement et le confinement de l'eau.
9. Hygiène maximale.
10. Étanchéité totale.
11. Possibilité de mise en œuvre avec diverses collections Anti dérapant Florim.
12. Incidence réduite dans le coût global de la piscine.
13. La découpe des pièces sur le chantier doit être effectuée avec des systèmes adéquats (par ex. découpe à eau avec disque diamanté).

PIÈCES COUPÉES

Il est possible de fournir des pièces coupées sur mesure de diverses formes et dimensions. Prix et conditions de vente à établir avec une offre spécifique de la part de la division «FLORIM SOLUTIONS».

CARACTERÍSTICAS - VENTAJAS TÉCNICAS

1. Modularidad en base a 60/ 80 cm (según la colección elegida)
2. Facilidad de colocación, con encolados de uso normal para cerámicos.
3. Elevada ligereza.
4. Alta resistencia mecánica a las cargas.
5. Seguridad contra el deslizamiento.
6. Constancia y precisión dimensional.
7. Ergonomía que facilita el agarre manual.
8. Configuración que optimiza el desbordamiento y la contención del agua.
9. Máxima higiene.
10. Total impermeabilidad.
11. Posibilidad de realización con las distintas colecciones de antideslizantes Florim.
12. Reducida incidencia en el coste total de la tina.
13. El corte de las piezas en las obras se debe realizar con sistemas adecuados (por ejemplo: corte de agua con disco diamantado).

CORTES

Es posible proveer piezas cortadas a la medida de varias formas y dimensiones. Los precios y condiciones de venta se deben fijar mediante una oferta específica de la división "FLORIM SOLUTIONS".

WAVE/OCEAN/PACKAGES

WAVE LINEARE	30,5x60
WAVE LINEARE	40,5x80
WAVE ANGOLO AE	30,5x30,5
WAVE ANGOLO AE	40,5x40,5
WAVE ANGOLO AI 45°	30,5x60x60
WAVE ANGOLO AI 45°	40,5x80x80
OCEAN LINEARE	32x60
OCEAN ANGOLO AE	30,5x30,5
OCEAN ANGOLO AI 45°	32x60x60

TECHNICAL CHARACTERISTICS - ADVANTAGES

1. Modularity with 60/ 80 CM (based on the chosen collection)
2. Easy to lay with adhesives normally used for ceramic materials.
3. Ultra-light weight.
4. High mechanical load resistance.
5. Non-slip safety.
6. Dimensional constancy and precision.
7. Ergonomics that facilitate manual gripping.
8. Conformation that optimises the overflow and containment of water.
9. Maximum hygiene.
10. Total impermeability.
11. Possibility to create using different Florim antislip collections.
12. Reduced incidence on the total cost of the pool.
13. The cutting of the pieces on the work site must be done using suitable systems (e.g. water cut with diamond disk).

CUTS

It is possible to supply pieces cut to measure in various shapes and sizes. Prices and sales conditions are to be stipulated with a specific offer by the FLORIM SOLUTIONS Division.

MERKMALE - TECHNISCHE VORZÜGE

1. Modularität auf der Basis von 60/80 cm (basierend auf der ausgesuchten Kollektion)
2. Einfache Verlegung mit den üblichen Klebern für Keramik.
3. Äußerste Leichtigkeit.
4. Hohe mechanische Belastungsfestigkeit.
5. Rutschfestigkeit.
6. Maßbeständigkeit und -genauigkeit.
7. Ergonomische Form, die das Greifen mit der Hand erleichtert.
8. Beschaffenheit, die den Überlauf und die Eindämmung des Wassers optimiert.
9. Maximale Hygiene.
10. Vollkommene Wasserundurchlässigkeit.
11. Möglichkeit der Herstellung mit verschiedenen rutschfest Serien von Florim.
12. Geringe Auswirkung auf die Gesamtkosten des Beckens.
13. Das Schneiden der Teile an der Baustelle hat mit geeigneten Systemen (z.B. Wasserstrahlschneiden mit Diamantscheibe) zu erfolgen.

ZUSCHNITT

Es können nach Maß zugeschnittene Teile in verschiedenen Formen und Größen geliefert werden. Preise und Verkaufsbedingungen sind in speziellem Angebot der Abteilung "FLORIM SOLUTIONS" festzulegen.

ХАРАКТЕРИСТИКИ – ТЕХНИЧЕСКИЕ ПРЕИМУЩЕСТВА

1. Модульность со стандартом 60/80 см (в зависимости от выбранной коллекции)
2. Легкость кладки с использованием обычных замазок и мастик для керамики.
3. Повышенная легкость.
4. Повышенная механическая прочность к нагрузкам.
5. Безопасность в отношении подскользывания.
6. Размерная неизменность и точность.
7. Эргономика, облегчающая захват руками.
8. Форма, оптимизирующая погружение и удерживание в воде.
9. Максимальная гигиеничность.
10. Полная водонепроницаемость.
11. Возможность использования различных коллекций Florim с противоскользящей поверхностью
12. Низкий процент затрат по отношению к общей стоимости бассейна.
13. Нарезка элементов по месту кладки должна осуществляться с помощью соответствующих систем (напр., водная резка алмазным диском).

РАЗРЕЗАННЫЕ ДЕТАЛИ

Возможна поставка разрезанных под заказ деталей разных форм и размеров. Цены и условия продажи согласовываются отдельно, путем подготовки сметы подразделением компании «FLORIM SOLUTIONS».

BOXES



PALLETS



PZ	MQ	KG	PZ	MQ	KG
2	-	8,60	-	-	-
2	-	7,70	-	-	-
2	-	4,90	-	-	-
1	-	4,00	-	-	-
1	-	6,50	-	-	-
1	-	11,50	-	-	-
2	-	5,20	-	-	-
1	-	2,40	-	-	-
1	-	7,80	-	-	-

FLORIM OVERSIZE

magnUm[®]

IMBALLI E DECORI

PACKAGING AND DECORATIONS

EMBALLAGES ET DÉCORS



VERPACKUNGEN UND DEKORS

EMBALAJES Y DECORACIONES

УПАКОВКА И ДЕКОРЫ

TABELLA IMBALLI

PACKAGE TABLE/TABLEAU DE EMBALLAGES/TABELLE FORMATE/TABLA DE LOS EMBALAJES/Таблица упаковок
#6 SPESSORE / THICKNESS/ÉPAISSEUR/STÄRKE/ESPESOR/ТОЛЩИНА

			BOXES 				PALLET 		
			ML	PZ	MQ	KG	BOX	MQ	KG
	80x80	31 ^{1/2} "x31 ^{1/2} "	-	3	1,92	27,80	40	76,80	1140
	60x120	23 ^{5/8} "x47 ^{1/4} "	-	3	2,16	31,30	30	64,80	960
MOSAICO 1,5x3	30x30	11 ^{4/5} "x11 ^{4/5} "	-	11	1,00	16,50	-	-	-
MOSAICO 7,5x7,5	30x30	11 ^{4/5} "x11 ^{4/5} "	-	11	1,00	16,50	-	-	-
MURETTO 7,5x15	30x30	11 ^{4/5} "x11 ^{4/5} "	-	11	1,00	16,50	-	-	-
BATTISCOPIA	4,6x80	1 ^{4/5} "x31 ^{1/2} "	14,40	18	-	8,60	-	-	-
	4,6x60	1 ^{4/5} "x23 ^{5/8} "	14,40	24	-	8,60	-	-	-

DECORI/ DECORS

Note Imballo. Tutti i singoli pezzi tagliati vengono numerati con applicazione sulla parte a vista di un pezzo di nastro isolante dove è riportato il n° del pezzo. Le scatole sono rivestite internamente di polistirolo per garantire l'integrità dei singoli pezzi. Su ogni scatola è riportato: N° dei pezzi totali - Numerazione di ciascun pezzo. Sulla palette viene applicata una pallet card ed una busta in plastica contenente lo schema di montaggio. Per richieste di formati inferiori al modulo base (120x240 o 160x240), resta in vigore la richiesta di lavorazioni fuori standard. N. B. Il prezzo di listino del decoro si riferisce a formato standard. Eventuali lavorazioni su misura verranno valutate su richiesta. (Il servizio clienti è a disposizione per informazioni e ulteriori dettagli a riguardo).

Packing notes. Each individual cut piece is given a number. The piece number is shown on the exposed side of a strip of insulation tape. The boxes are padded on the inside with polystyrene to protect the individual pieces. Each box bears the following information: Total n° of pieces - Code number of each piece. The pallet comes with a pallet card and a plastic pouch containing the assembly diagram. For smaller sizes requests different from basic modules (120x240 or 160x240), you need to follow the procedure for requesting a non-standard format. N. B. The decor's price list refers to the standard format featuring one colour. Any custom-work will be assessed upon request. Please call our Customer Service for more information.

Remarques concernant l'emballage. Chaque pièce découpée est numérotée avec une application sur la partie visible d'un morceau de ruban isolant sur lequel figure le n° de la pièce. Les boîtes sont revêtues intérieurement de polystyrène afin de garantir l'intégrité de chaque pièce. Sur chaque boîte figurent: le nombre de pièces totales et la numérotation de chaque pièce. Une carte de la palette et un sachet en plastique contenant le schéma du montage sont appliqués sur la palette. Pour toute demande de formats inférieurs au module de base (120x240 ou 160x240), reste en vigueur la demande de hors standard. N. B. Le prix catalogue du décor se réfère au format standard. Les éventuels traitements sur mesure seront évalués sur demande. Le service clientèle est à votre disposition si vous avez besoin d'informations et de plus amples détails.

Verpackungshinweise. Alle geschneittenen einzelnen Teile werden nummeriert, wobei die Nummer des Teils auf der sichtbaren Seite eines Stücks Isolierband angebracht ist. Die Kartonverpackungen sind innen mit Polystyrol ausgelegt, um die Unversehrtheit der einzelnen Teile zu gewährleisten. Folgende Angaben befinden sich auf jedem Karton: Gesamtzahl der Teile Nummerierung jedes Teils. An der Palette sind eine Palettenkarte und ein Kunststoffbeutel mit dem Montageplan angebracht. Für Anfragen von kleineren Formaten als vom Standard vorgesehen (120x240 oder 160x240) gilt der übliche Bearbeitungsvorgang für Sonderanfertigungen. N. B. Der Listenpreis bezieht sich auf die Dekoration im Standard-Format, einfarbig. Eventuelle kundenspezifische Verarbeitungen werden auf Anfrage kalkuliert. Der Kundenservice steht für weitere Informationen und Einzelheiten hierzu jederzeit zur Verfügung.

Notas sobre el embalaje. Todas las partes cortadas se enumeran colocando en la parte a la vista de la pieza una cinta adhesiva donde se reproduce el n.º de la pieza. El interior de las cajas se reviste con poliestireno para garantizar la integridad de cada una de las piezas. Sobre cada caja se reproduce: N.º de las piezas totales - Numeración de cada pieza. En la paleta se coloca una "pallet card" y una bolsa plástica que contiene el esquema del montaje. Para pedidos de formatos inferiores a los módulos de base (120x240 o 160x240), es necesario solicitar las elaboraciones no estándar. N. B. El precio de catálogo del decoro se refiere al formato estándar. Las elaboraciones a medida se evaluarán bajo pedido. El servicio de atención al cliente está a su disposición para proporcionarle más información y detalles al respecto.

Примечания по Упаковке. Каждый отдельный вырезанный элемент специально пронумерован с нанесением на лицевую поверхность куска изолянта с номером элемента. Коробки внутри полностью покрыты полистиролом для обеспечения целостности каждого отдельного элемента. На каждой из коробок указано: Общее количество элементов - Нумерация каждого из элементов. На поддон приклеивается карточка паллеты и пластиковый пакет, содержащий схему монтажа. Запрос на форматы, меньше чем стандартные модули (120*240 или 160 *240), рассматривается как запрос на изготовление нестандартных изделий. N. B. Цена прайс-листа отделочных материалов указана для стандартного формата, одноцветного и однослойного варианта. Цена на другие виды отделки сообщается по запросу. Центр обслуживания клиентов всегда предоставит вам более подробную информацию и все интересующие вас детали.

Listino IMBALLI / Price List PACKAGING	
TIPO / TYPE	PREZZO / PRICE
A: CASSA / CRATE cm 175x340x31h - 68 ^{8/9} "x133 ^{6/7} "x12 ^{1/5} "	230,00 €
B: CASSA / CRATE cm 145x292x35h - 57" ⁷ x115"x13 ^{7/9} "	160,00 €
C: CASSA / CRATE cm 136x263x34h - 53 ^{1/2} "x103 ^{1/2} "x13 ^{2/5} "	160,00 €
D: CASSA / CRATE cm 135x144x41h - 53 ^{1/7} "x56 ^{2/3} "x16 ^{1/7} "	-
E: CASSA / CRATE cm 135x144x66h - 53 ^{1/7} "x56 ^{2/3} "x26"	-
G: CASSA / CRATE cm 174x183x41h - 68 ^{1/2} "x72x16 ^{1/7} "	160,00 €
H/I: CAVALLETTO / A-FRAME cm 73x330x200h - 28 ^{3/4} "x130"x78 ^{3/4} "	360,00 €
L: CAVALLETTO / A-FRAME cm 75x339x186h - 29 ^{1/2} "x133 ^{1/2} "x73 ^{2/9} "	500,00 €
M: CAVALLETTO / A-FRAME cm 75x290x146h -29 ^{1/2} "x114 ^{1/6} "x57 ^{1/2} "	450,00 €
N: CAVALLETTO / A-FRAME cm 75x250x146h -29 ^{1/2} "x98 ^{3/7} "x57 ^{1/2} "	380,00 €
P: CAVALLETTO / A-FRAME cm 75x250x160h -29 ^{1/2} "x98 ^{3/7} "x63"	280,00 €
R: CAVALLETTO / A-FRAME cm 75x170x195h -29 ^{1/2} "x67"x76 ^{7/9} "	280,00 €

*Le lastre sono contenute in scatole da 2 pezzi ciascuna / Packing for this item is 2 slabs per box / Les plaques sont contenues dans des boîtes de 2 pièces chacune. Die Platten sind in Kartons zu je 2 Stück verpackt. / Las baldosas están empaquetadas en cajas de 2 piezas cada una / Данный материал упаковывается по 2 слэба в один ящик.

*per spedizioni >12 scatole / for shipments >12 boxes / pour les expéditions >12 boîtes / für Versandmengen >12 Schachteln / para envíos > 12 cajas / для отгрузок >12 коробок.

°per spedizioni ≤12 scatole / for shipments ≤12 boxes / pour les expéditions ≤12 boîtes / für Versandmengen ≤12 Schachteln / para envíos ≤12 cajas / для отгрузок ≤12 коробок.

TABELLA IMBALLI

PACKAGE TABLE/TABLEAU DE EMBALLAGES/TABELLE FORMATE/TABLA DE LOS EMBALAJES/Таблица упаковок
#6 SPESSORE / THICKNESS/ÉPAISSEUR/STÄRKE/ESPOR/ТОЛЩИНА

TIPO TYPE	formato LASTRA SLAB size	LASTRA SLAB		CASSA vuota empty CRATE			CASSA piena full CRATE	CAVALLETTO vuoto empty A-Frame			CAVALLETTO pieno full A-Frame
		MQ	KG	PZ	MQ	KG	KG	PZ	MQ	KG	KG
	A 160x320 63"x126"	5,12	74,15	14	71,68	140,5	1178,6	-	-	-	-
	B 120x280 47 ^{1/4} "x110 ^{1/4} "	3,36	48,65	20	67,20	90,00	1063	-	-	-	-
	C (6mm) 120x240 47 ^{1/4} "x94 ^{1/2} "	2,88	41,70	20	57,60	107,00	941	-	-	-	-
	C (10mm) 120x240 47 ^{1/4} "x94 ^{1/2} "	2,88	69,50	12	34,56	107,00	941	-	-	-	-
	D (6mm) 120x120 47 ^{1/4} "x47 ^{1/4} "	1,44	20,85	24*	34,56	50,00	550	-	-	-	-
	D (10mm) 120x120 47 ^{1/4} "x47 ^{1/4} "	1,44	33,28	18*	25,92	50,00	649	-	-	-	-
	E (6mm) 120x120 47 ^{1/4} "x47 ^{1/4} "	1,44	20,70	48*	69,12	70	1065,1	-	-	-	-
	E (10mm) 120x120 47 ^{1/4} "x47 ^{1/4} "	1,44	23,11	36*	51,84	70	903,34	-	-	-	-
	G 160x160 63"x63"	2,56	37,06	24	61,44	45,00	934,44	-	-	-	-
	H 160x320 63"x126"	5,12	74,15	-	-	-	-	44	225,28	220,00	3482,6
	I 120x280 47 ^{1/4} "x110 ^{1/4} "	3,36	48,65	-	-	-	-	44	147,84	220,00	2360,6
	L 160x320 63"x126" Cavalletto in lamiera zincata Zinc-plated sheet A-frame	5,12	74,15	-	-	-	-	44	225,28	120,00	3382,6
	M 120x280 47 ^{1/4} "x110 ^{1/4} " Cavalletto in lamiera zincata Zinc-plated sheet A-frame	3,36	48,65	-	-	-	-	44	147,84	108,5	2249,1
	N (6mm) 120x240 47 ^{1/4} "x94 ^{1/2} " Cavalletto in lamiera zincata Zinc-plated sheet A-frame	2,88	41,70	-	-	-	-	44	126,72	92,5	1941,5
	N (10mm) 120x240 47 ^{1/4} "x94 ^{1/2} " Cavalletto in lamiera zincata Zinc-plated sheet A-frame	2,88	69,50	-	-	-	-	28	80,64	92,5	2038,5
	P (6mm) 120x240 47 ^{1/4} "x94 ^{1/2} "	2,88	41,70	-	-	-	-	44	126,72	170,00	2004,8
	P (10mm) 120x240 47 ^{1/4} "x94 ^{1/2} "	2,88	69,50	-	-	-	-	28	80,64	170,00	2116
	R 160x160 63"x63"	2,56	37,07	-	-	-	-	44	112,64	160,00	1791,08

ESEMPI DI PERSONALIZZAZIONE DECORI IN DIMENSIONE 120X240

EXAMPLES OF DECORS CUSTOMIZATIONS 120X240 SIZE

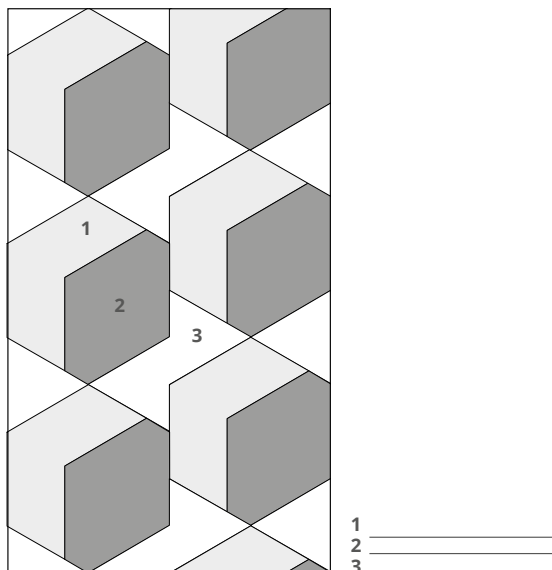

In ogni decoro è possibile selezionare materie e superfici combinandole nel modo in cui si desidera (vedi esempio).
Il decoro può essere adattato a qualsiasi misura richiesta.

For each decor you can select materials and surfaces combining them in the way you prefer (see example).
The decoration can be adapted to any requested measurements.

ABBINAMENTI CONSIGLIATI FLOOR GRES.

FLOOR GRES SUGGESTED COMBINATIONS.

INDUSTRIAL

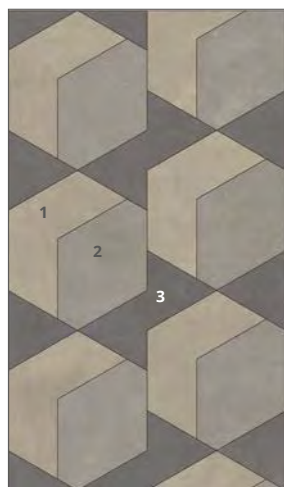

FLA / 749488 ■ FL-58900

1/ INDUSTRIAL / SAGE
2/ INDUSTRIAL / STEEL
3/ INDUSTRIAL / PLOMB

FLOWTECH

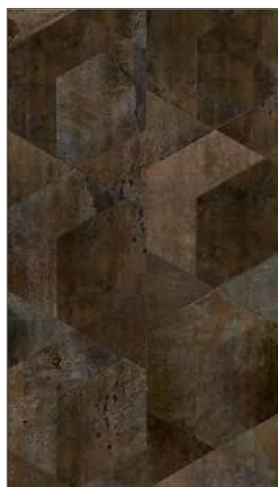

FLOWTECH / AGED BRONZE

ESEMPI DI PERSONALIZZAZIONE DECORI
 EXAMPLES OF DECORS CUSTOMIZATIONS

**FLOWTECH
 INDUSTRIAL**

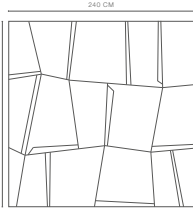
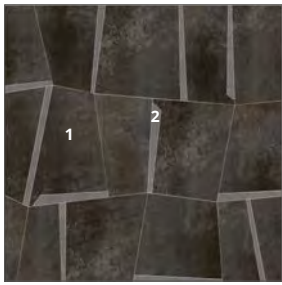

FLB / 749489 ■ FL-58900

1/ **FLOWTECH** / BURNISHED
 2/ **INDUSTRIAL** / PLOMB

INDUSTRIAL

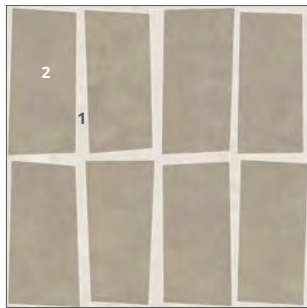

FLC / 749490 ■ FL-58900

1/ **INDUSTRIAL** / IVORY
 2/ **INDUSTRIAL** / SAGE

STONTECH/4.0

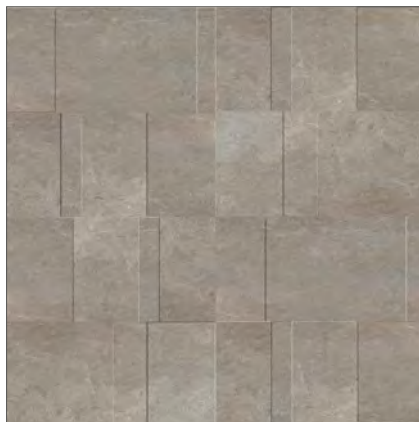

FLE A/B/C / 750220 ■ FL-58900

STONTECH/4.0 / STONE_03



FLE A / 749497 ■ FL-58900



FLE B / 749498 ■ FL-58900

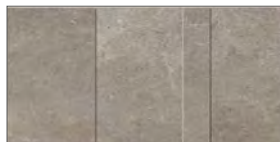

FLE C / 749499 ■ FL-58900

ESEMPI DI PERSONALIZZAZIONE DECORI IN DIMENSIONE 160X240

EXAMPLES OF DECORS CUSTOMIZATIONS 160X240 SIZE

INDUSTRIAL



FLD A/B/C/D/E/F / 750219
■ FL-58900

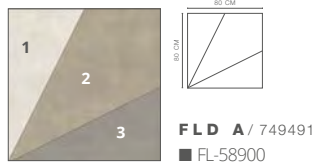

1/ INDUSTRIAL / IVORY
2/ INDUSTRIAL / SAGE
3/ INDUSTRIAL / STEEL

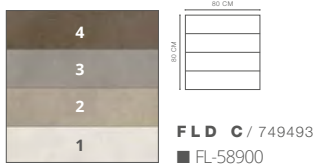

1/ INDUSTRIAL / IVORY
2/ INDUSTRIAL / SAGE
3/ INDUSTRIAL / STEEL
4/ INDUSTRIAL / MOKA

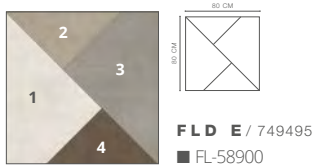

1/ INDUSTRIAL / IVORY
2/ INDUSTRIAL / SAGE
3/ INDUSTRIAL / STEEL
4/ INDUSTRIAL / MOKA

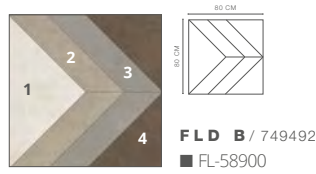

1/ INDUSTRIAL / IVORY
2/ INDUSTRIAL / SAGE
3/ INDUSTRIAL / STEEL
4/ INDUSTRIAL / MOKA

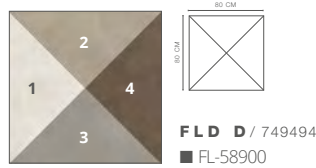

1/ INDUSTRIAL / IVORY
2/ INDUSTRIAL / SAGE
3/ INDUSTRIAL / STEEL
4/ INDUSTRIAL / MOKA



1/ INDUSTRIAL / IVORY
2/ INDUSTRIAL / SAGE
3/ INDUSTRIAL / STEEL
4/ INDUSTRIAL / MOKA

BUILDTECH/2.0 INDUSTRIAL

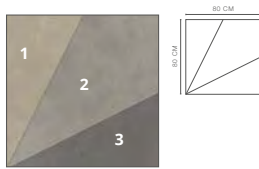

1/ INDUSTRIAL / SAGE
2/ INDUSTRIAL / STEEL
3/ INDUSTRIAL / PLOMB

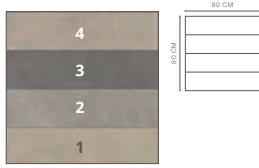

1/ INDUSTRIAL / SAGE
2/ INDUSTRIAL / STEEL
3/ INDUSTRIAL / PLOMB
4/ BUILDTECH/2.0 / BUILD MUD CE

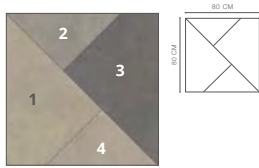

1/ INDUSTRIAL / SAGE
2/ INDUSTRIAL / STEEL
3/ INDUSTRIAL / PLOMB
4/ BUILDTECH/2.0 / BUILD MUD CE

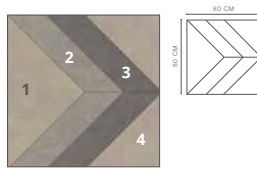

1/ INDUSTRIAL / SAGE
2/ INDUSTRIAL / STEEL
3/ INDUSTRIAL / PLOMB
4/ BUILDTECH/2.0 / BUILD MUD CE

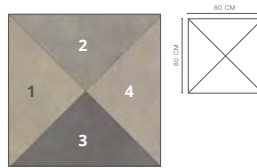

1/ INDUSTRIAL / SAGE
2/ INDUSTRIAL / STEEL
3/ INDUSTRIAL / PLOMB
4/ BUILDTECH/2.0 / BUILD MUD CE

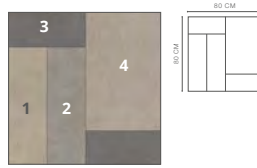

1/ INDUSTRIAL / SAGE
2/ INDUSTRIAL / STEEL
3/ INDUSTRIAL / PLOMB
4/ BUILDTECH/2.0 / BUILD MUD CE

ESEMPI DI PERSONALIZZAZIONE DECORI IN DIMENSIONE 120X240

EXAMPLES OF DECORS CUSTOMIZATIONS 120X240 SIZE

STONTECH/4.0

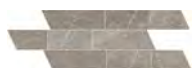

FLF / 749500 ■ FL-58900

STONTECH/4.0 / STONE_03

INDUSTRIAL



FLG / 749501 ■ FL-58900

1/ INDUSTRIAL / STEEL
2/ INDUSTRIAL / PLOMB

INDUSTRIAL

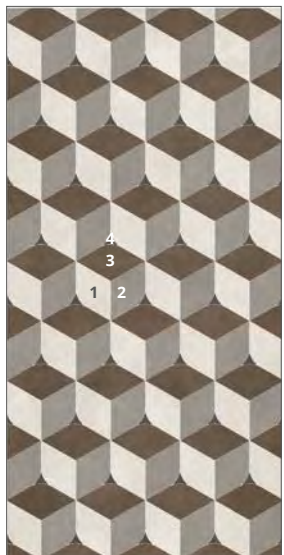

FLH / 749502 ■ FL-58900

1/ INDUSTRIAL / IVORY
2/ INDUSTRIAL / STEEL
3/ INDUSTRIAL / MOKA
4/ INDUSTRIAL / PLOMB

INDUSTRIAL



FLI / 749503 ■ FL-58900

1/ INDUSTRIAL / SAGE
2/ INDUSTRIAL / STEEL

ESEMPI DI PERSONALIZZAZIONE DECORI IN DIMENSIONE 120X240

EXAMPLES OF DECORS CUSTOMIZATIONS 120X240 SIZE

BUILDTECH/2.0



FLL / 749504 ■ FL-58900

- 1/ BUILDTECH/2.0 / BUILD MUD CE
- 2/ BUILDTECH/2.0 / BUILD MUD CE
- 3/ BUILDTECH/2.0 / BUILD WHITE CE
- 4/ BUILDTECH/2.0 / BUILD WHITE CE

BUILDTECH/2.0

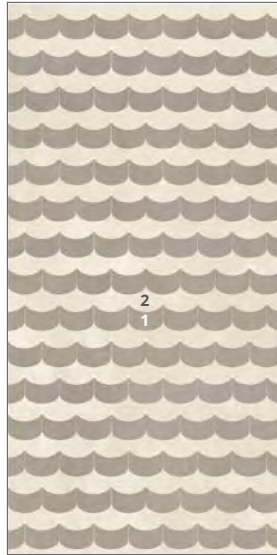

FLM / 749505 ■ FL-58900

- 1/ BUILDTECH/2.0 / BUILD MUD CE
- 2/ BUILDTECH/2.0 / BUILD WHITE CE

**INDUSTRIAL
STONTECH/4.0**



FLN / 749506 ■ FL-58900

- 1/ STONTECH/4.0 / STONE_03
- 2/ INDUSTRIAL / PLOMB

INDUSTRIAL



FLO / 749507 ■ FL-58900

- 1/ INDUSTRIAL / MOKA
- 2/ INDUSTRIAL / TAUPE
- 3/ INDUSTRIAL / IVORY

ESEMPI DI PERSONALIZZAZIONE DECORI

EXAMPLES OF DECORS CUSTOMIZATIONS

BUILDTECH/2.0



FLP / 749508 ■ FL-58900

- 1/ BUILDTECH/2.0 / BUILD WHITE CE
- 2/ BUILDTECH/2.0 / BUILD MUD CE
- 3/ BUILDTECH/2.0 / BUILD WHITE CE
- 4/ BUILDTECH/2.0 / BUILD MUD CE

ESEMPI DI PERSONALIZZAZIONE DECORI IN DIMENSIONE 265X240

EXAMPLES OF DECORS CUSTOMIZATIONS 265X240 SIZE

INDUSTRIAL / BUILDTECH/2.0

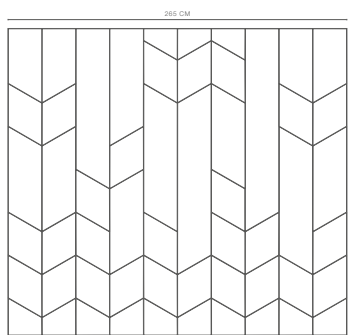
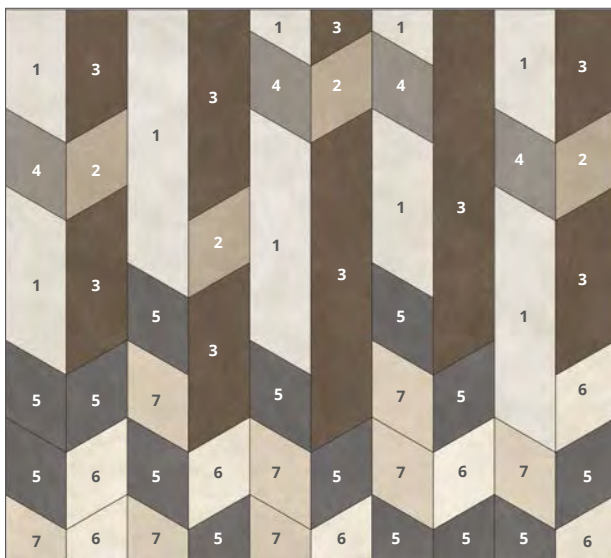

FLQ / 749509 ■ FL-58900

- 1/ INDUSTRIAL / IVORY
- 2/ INDUSTRIAL / TAUPE
- 3/ INDUSTRIAL / MOKA
- 4/ INDUSTRIAL / STEEL
- 5/ INDUSTRIAL / PLOMB
- 6/ BUILDTECH/2.0 / BUILD WHITE CE
- 7/ BUILDTECH/2.0 / BUILD BONE CE

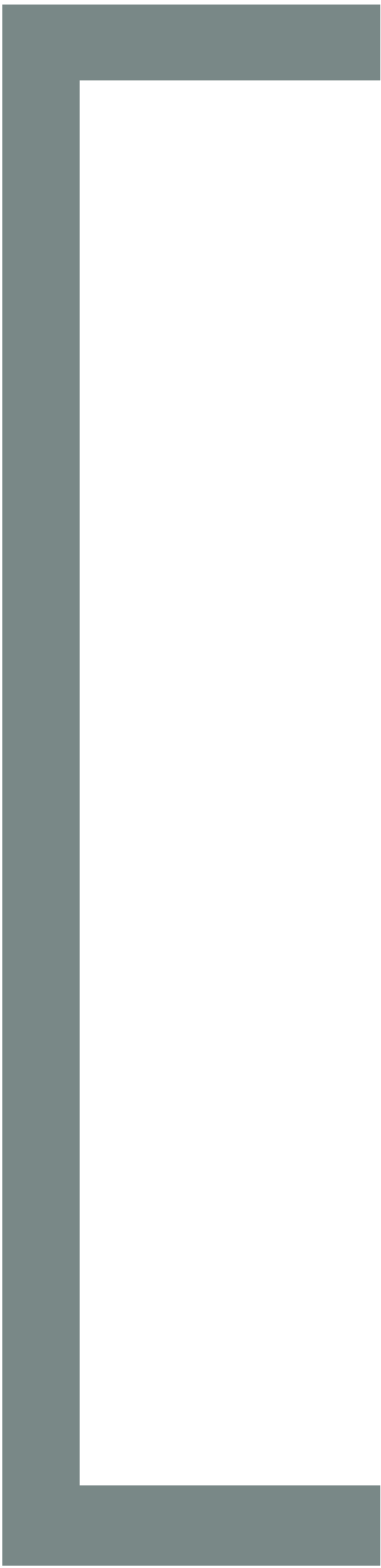

FLORIM OVERSIZE
magnUm[®]

MODERN DESIGN
PERSPECTIVES ARE
CHANGING: AMAZING
SIZES IN A THICKNESS
OF JUST 6 MM,
LIGHT, VERSATILE
AND STRONG, WITH
EXTRAORDINARY
AESTHETIC APPEAL.

GRAPHICS

WHITE

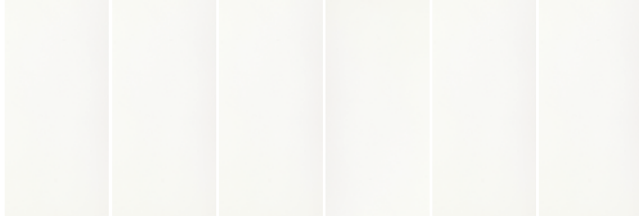

BLACK

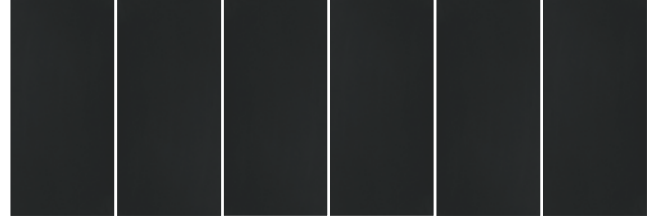

WAVE

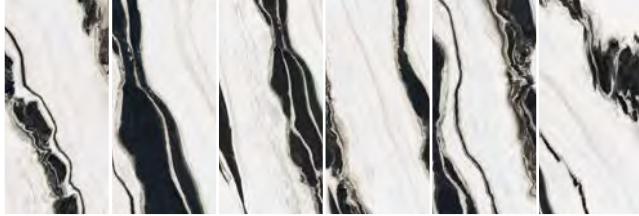

FRAGMENT

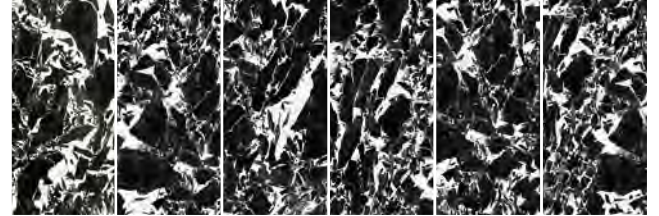

BREACH

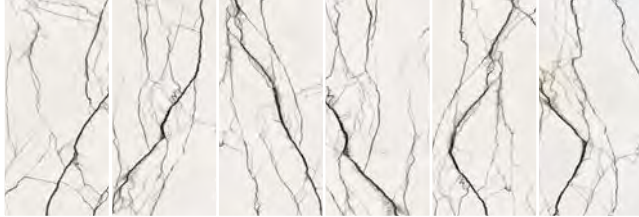

FALL

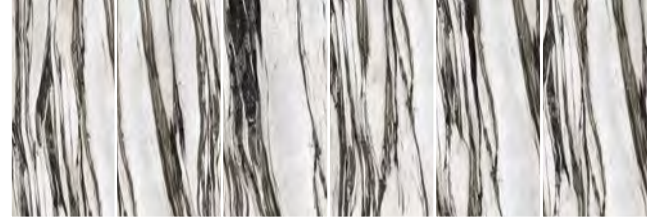

PEBBLE

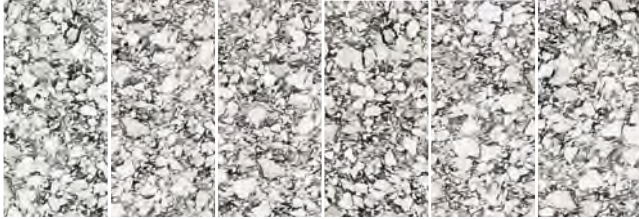

FLOW

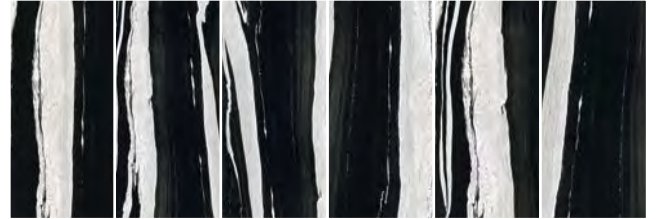

B&W_MARBLE

STONE_01



STONE_02



STONE_03



STONE_05

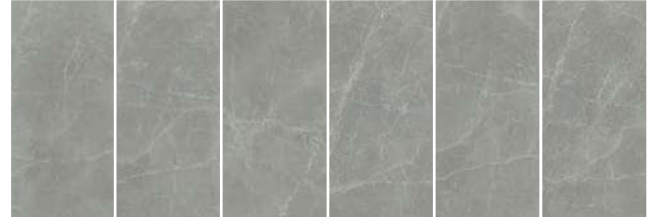

STONTECH/4.0

Le immagini riportate non rappresentano necessariamente il numero di grafiche del prodotto. Il numero di grafiche è variabile in funzione del formato e del colore di riferimento.
 Images do not necessarily represent the number of patterns in the product's range. The number of different patterns varies according to size and color of the item. / Les images reportées ne représentent pas forcément le nombre de graphismes du produit. Leur nombre varie en fonction du format et de la couleur choisie. / Die Abbildungen geben keine bindende Auskunft bzgl. der Anzahl verschiedener Grafiken. Die Anzahl der Grafiken ist abhängig von Format und Farbe der jeweiligen Kollektion. / Las imágenes mostradas no representan necesariamente el número de gráficas del producto. El número de gráficas varía en función del formato y del color. / Представленные изображения необязательно обозначают количество графических вариаций «рубашек» материала. Количество изображений вариативно, зависит от формата и цвета продукта.

INDUSTRIAL

IVORY



TAUPE



MOKA



SAGE



STEEL



PLOMB

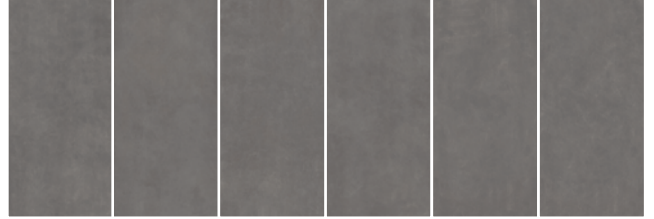

FLOWTECH

RUSSET



AGED BRONZE



BURNISHED



RAWTECH

RAW-WHITE



RAW-DUST



BUILD_WHITE CE



BUILD_BONE CE



BUILD_MUD CE

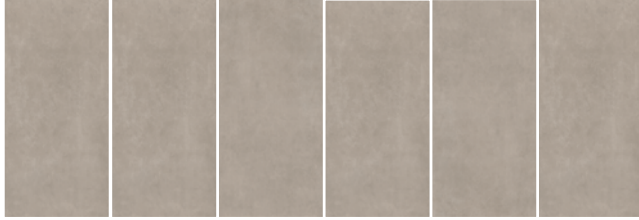

BUILD_COAL CE



CREAM



MUSTARD

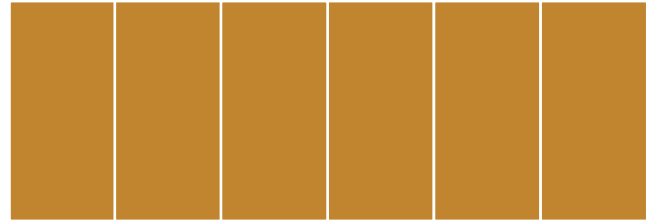

SCARLET

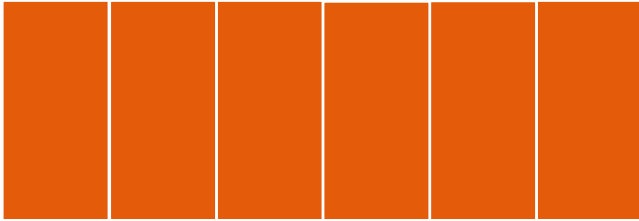

CRIMSON

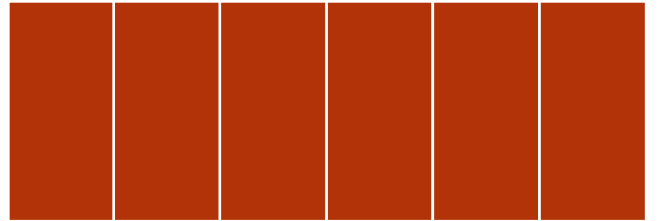

FUCHSIA

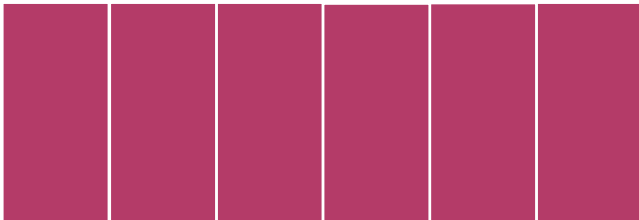

BURGUNDY

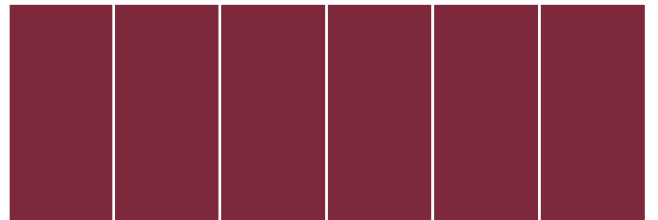

SKY

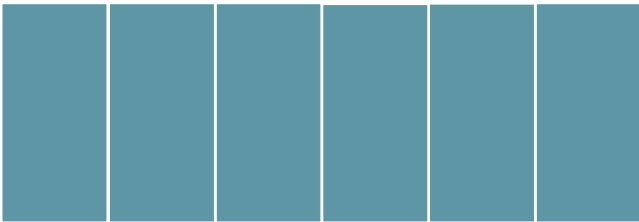

MIDNIGHT

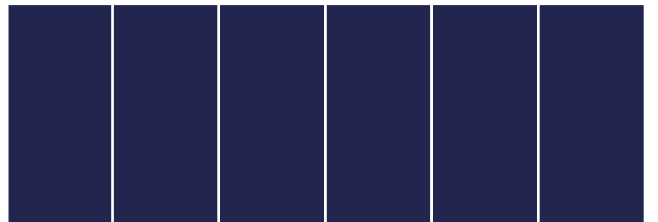

TEAL

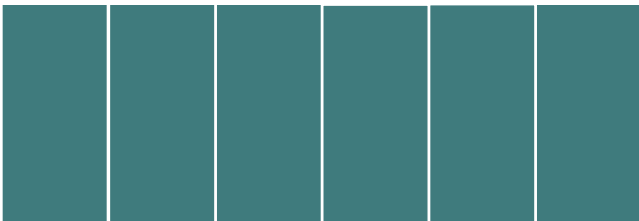

BOTTLE

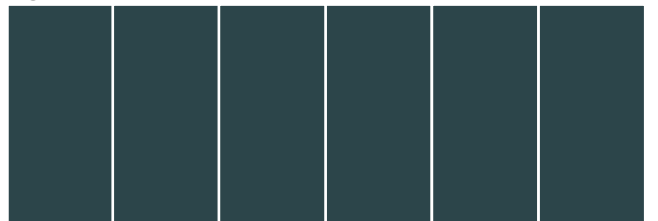

PUMICE_GROUND



PUMICE_FLAKES



DESERT_GROUND

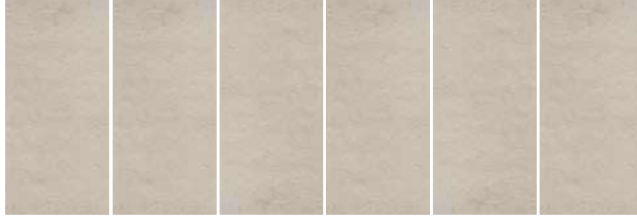

DESERT_FLAKES



FOG_GROUND



FOG_FLAKES



CARBON_GROUND

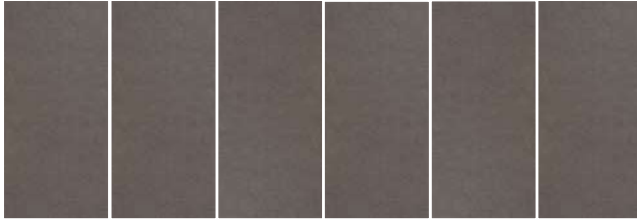

CARBON_FLAKES



SAVANNAH_GROUND



SAVANNAH_FLAKES



OUTBACK_GROUND



OUTBACK_FLAKES



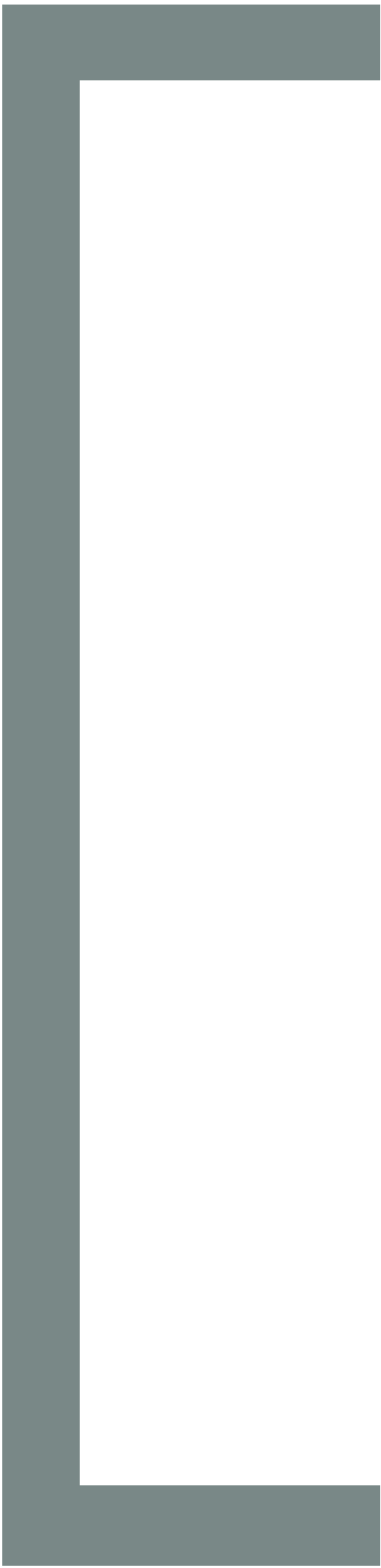

CERTIFICAZIONI

CERTIFICATIONS

CERTIFICATIONS

ZERTIFIZIERUNGEN

CERTIFICACIONES

Сертификаты

Certificazioni di sistema / System certification / Certification de système / Systemzertifizierung / Certificación de sistema СЕРТИФИКАЦИЯ СИСТЕМЫ

La soddisfazione del Cliente, nel rispetto dell'Ambiente e della Sicurezza dei propri collaboratori, è la condizione essenziale per il successo della nostra azienda. Di conseguenza, Florim si impegna a porre come obiettivo prioritario il costante miglioramento dei propri prodotti e servizi. Florim Ceramiche S.p.A SB è la prima azienda nel settore a ottenere la certificazione del proprio Sistema di Gestione della Qualità, dell'Ambiente e della Salute e Sicurezza dei lavoratori e dell'Energia, in base alle norme **UNI EN ISO 9001, UNI EN ISO 14001, ISO 45001 e UNI EN ISO 50001**, relativamente a progettazione, produzione e vendita di piastrelle ceramiche in tutte le tipologie produttive.

Customer satisfaction, together with respect for the environment and for the safety of those who work with us are essential conditions for our company's success. As a result, Florim is committed to making the constant improvement of its products and services a priority. Florim Ceramiche S.p.A SB is the first company in the sector to obtain certification for its Quality Management System, its Environmental Management System and its Management System for the Health and Safety of workers and energy, according to **UNI EN ISO 9001, UNI EN ISO 14001, ISO 45001 and UNI EN ISO 50001** standards, relating to the design, manufacture and sales of ceramic tiles in all of its production types.

La satisfaction du client, dans le respect de l'environnement et de la sécurité de ses collaborateurs, est la condition essentielle au succès de notre entreprise. Florim s'engage donc à faire de l'amélioration constante de ses produits et services un objectif prioritaire. Florim Ceramiche S.p.A SB est la première entreprise du secteur à obtenir la certification de son système de gestion de la qualité, de l'environnement, de la santé et de la sécurité des employés et de l'énergie, conformément aux normes **UNI EN ISO 9001, UNI EN ISO 14001, ISO 45001 et UNI EN ISO 50001**, en matière de conception, production et vente de tous types de carreaux céramiques.

Die Zufriedenheit des Kunden unter Berücksichtigung von Umwelt und Sicherheit unserer Mitarbeiter ist die grundlegende Bedingung für den Erfolg unseres Unternehmens. Demzufolge setzt sich die Firma Florim dafür ein, die ständige Verbesserung ihrer Produkte und Dienstleistungen zum vorrangigen Ziel zu machen. Die Firma Florim Ceramiche S.p.A SB ist das erste Unternehmen in diesem Fachbereich, das die Zertifizierung seines Managementsystems der Qualität, Umwelt und Gesundheit und Sicherheit, und Energie auf Grund der Bestimmungen **UNI EN ISO 9001, UNI EN ISO 14001, ISO 45001 und UNI EN ISO 50001**, in Bezug auf Entwurf, Produktion und Verkauf von Keramikfliesen in allen Herstellungsarten erhielt.

La satisfacción del Cliente, con un respeto total del ambiente y seguridad de sus colaboradores, representa la condición esencial para el éxito de nuestra empresa. Por ello, Florim se compromete a perseguir, como objetivo prioritario, una mejora constante de sus productos y servicios. Florim Ceramiche S.p.A SB es la primera empresa en el sector que ha obtenido el certificado del Sistema de Gestión de la Calidad, Ambiente, Salud y Seguridad de los trabajadores y energía en base a la normativa **UNI EN ISO 9001, UNI EN ISO 14001, BS OHSAS 18001 y UNI EN ISO 50001**, en relación al proyecto, producción y venta de baldosas de cerámica en todas las tipologías productivas.

Важнейшее условие успеха нашей компании заключается в удовлетворении потребностей наших клиентов путем соблюдения требований по охране окружающей среды, охране труда и технике безопасности. В связи с этим приоритетной задачей компании Florim является постоянное повышение качества производимой продукции и предоставляемых услуг. Florim Ceramiche S.p.A SB является первой в своей сфере компанией, получившей сертификаты соответствия системы менеджмента качества, экологии и безопасности труда и охраны здоровья в соответствии с требованиями и энергия стандартов **UNI EN ISO 9001, UNI EN ISO 14001, ISO 45001 e UNI EN ISO 50001**, применительно к проектированию, производству и продаже керамической плитки всех производимых типов.



Sistema di gestione della Qualità:
Certificato n° 50 100 1271

Sistema di gestione dell'Ambiente:
Certificato n° 50 100 100 74

Sistema di gestione della Salute e Sicurezza dei lavoratori:
Certificato n° 50 100 13825

Sistema di gestione dell'Energia:
Certificato n° 50 100 13545

L'ente certificatore è il Technischerhungs-Verein (TÜV), che è stato scelto per la severità e il riconoscimento a livello internazionale.

The certification institute is Technischerhungs-Verein (TÜV), chosen for its stringent standards and international recognition.

L'organisme de certification est le Technischerhungs-Verein (TÜV), qui a été choisi pour sa rigueur et sa reconnaissance au niveau international.

Prüfbehörde ist der Technische Überwachungsverein (TÜV), welcher aufgrund seiner strengen Prüfkriterien und seiner internationalen Bekanntheit gewählt wurde.

El ente certificador es el Technischerhungs-Verein (TÜV), que ha sido elegido por su severidad y su reconocimiento a nivel internacional.

Сертифицирующая организация - Technischerhungs-Verein (TÜV), которая была выбрана благодаря ее суровости и признанию на международном уровне.

Florim e l'ambiente / Florim and the environment / Florim et l'environnement / Florim und die umwelt / Florim y el ambiente Florim и окружающая среда



ENVIRONMENT PRIORITY ONE / Using nature's resources responsibly

Per sottolineare l'attenzione e l'impegno verso la tutela dell'ambiente, in accordo con la norma ISO 14021 (Environmental labels and declarations) Florim afferma il proprio impegno nella continua innovazione tecnologica dei processi industriali.

To underline our care for the environment and our pledge to protect it in accordance with the ISO 14021 standards (Environmental labels and declarations), Florim affirms its commitment to continual technological innovation of the industrial processes.

Pour prouver l'attention qu'elle consacre depuis toujours à la protection de l'environnement, en accord avec la norme ISO 14021 (Environmental labels and declarations), la société Florim déclare son engagement dans l'innovation technologique continue des processus industriels.

Die Firma Florim möchte ihre Aufmerksamkeit und ihr Engagement zum Schutz der Umwelt gemäß der ISO-Norm 14021 (Environmental labels and declarations) hervorheben und bekräftigt deshalb, dass sie ständig auf technologische Innovation der Industrieprozesse.

Para subrayar la atención y el compromiso adquirido con la tutela del medio ambiente, de acuerdo con la norma ISO 14021 (Environmental labels and declarations) Florim reafirma su dedicación por la continua innovación tecnológica de los procesos industriales.

Чтобы подчеркнуть внимание и усилия, направленные на охрану окружающей среды, в соответствии с нормативом ISO 14021 (Environmental labels and declarations) фирма Флорим подтверждает собственные обязательства в плане постоянного технологического обновления промышленных процессов, для того чтобы.



EU Ecolabel: nr. IT/21/04

ECOLABEL

EcoLabel è il marchio europeo di qualità ecologica che premia i prodotti e i servizi migliori dal punto di vista ambientale (Regolamento CE n.1980/2000). Il marchio è uno strumento selettivo, basato sulla valutazione delle qualità ecologiche e prestazionali dell'intero ciclo di vita dei prodotti, ideato per premiare i prodotti e i servizi migliori dal punto di vista ambientale. In particolare, i requisiti imposti dall'Unione Europea e riconosciuti a Florim per alcune linee di prodotto tramite la concessione del marchio EcoLabel riguardano:

- Il minore consumo energetico dei processi di produzione
- Minori emissioni nell'aria e nell'acqua
- Miglioramento dell'informazione al consumatore e della gestione dei rifiuti.

EcoLabel is the European ecological quality mark which is granted to the best products and services from an environmental point of view (EC regulation no. 1980/2000). EcoLabel is a selective tool based on assessment of the ecological and performance qualities of the entire product lifecycle and is a reward for the best products and services from an environmental point of view. In particular, Florim was rewarded with the EcoLabel for some of its product lines having met the requirements imposed by the European Union:

- Reduced energy consumption in the production processes
- Reduced emissions into the air and waterways
- Enhanced information to the consumer and improved waste management.

EcoLabel est le label européen de qualité écologique décerné aux meilleurs produits et aux meilleurs services au point de vue environnement (Règlement CE n°1980/2000). Ce label qui constitue un outil sélectif, basé sur l'évaluation des qualités écologiques et des performances de tout le cycle de vie des produits, a été créé pour récompenser les produits et les services qui ont un impact réduit sur l'environnement. Le cahier des charges imposé par l'Union européenne et la marque Ecolabel décernée à Florim pour quelques lignes de produits concernent notamment :

- La réduction de la consommation d'énergie dans les processus de fabrication
- La réduction des émissions dans l'air et dans l'eau
- L'amélioration de l'information auprès des consommateurs et de la gestion des déchets.

EcoLabel ist das europäische Umweltzeichen für Öko-Qualität, das die besten umweltfreundlichen Produkte und Dienstleistungen auszeichnet (EG-Verordnung Nr. 1980/2000). Das Umweltzeichen ist ein selektives Instrument, das auf der Beurteilung der Umwelt- und Leistungsmerkmale der ganzen Lebensdauer von Produkten basiert und zur Auszeichnung der umweltfreundlichsten Produkte und Dienstleistungen eingeführt wurde. Die von der Europäischen Union auferlegten und der Firma Florim für einige Produktlinien durch die Gewährung des EcoLabel Umweltzeichens bescheinigten Voraussetzungen sind:

- Geringerer Energieverbrauch der Produktionsprozesse
- Weniger Emissionen in die Luft und das Wasser
- Verbesserte Verbraucherinformation und Abfallverwertung.

EcoLabel es la marca europea de calidad ecológica que se otorga a los mejores productos y servicios desde el punto de vista ambiental (Reglamento CE n° 1980/2000). La marca es un instrumento selectivo, basado en la valoración de las cualidades ecológicas y prestacionales del ciclo de vida de los productos, ideado para premiar aquellos productos y servicios que cumplen con estrictos criterios relativos al medio ambiente. Más concretamente, los requisitos impuestos por la Unión Europea, y respetados por Florim como así lo acredita la concesión de la marca EcoLabel para algunas líneas de producto, son los siguientes:

- Menor consumo energético de los procesos de producción
- Menores emisiones en el aire y en el agua
- Mejora de la información al consumidor y de la gestión de los residuos.

EcoLabel является европейской маркой экологического качества, которая присваивается лучшим продуктам и услугам с экологической точки зрения (Свод правил CE n.1980/2000). Эта марка является инструментом отбора, который оценивает экологические и функциональные качества продукта на протяжении его жизненного цикла, она была задумана как способ премирования продукции и услуг, наилучших с экологической точки зрения. В частности, реквизиты, установленные Евросоюзом и признанные для некоторых линий продукции Флорим путем присвоения знака EcoLabel, предусматривают:

- минимальное энергопотребление в процессе производства
- минимальные выбросы в воздух и в воду
- улучшение информированности потребителя и совершенствование способов обработки отходов.



BUREAU VERITAS

Bureau Veritas è il marchio che certifica la natura riciclata del materiale di cui è composto un prodotto, sottoponendo a verifica l'intero ciclo produttivo. Viene controllata e documentata la provenienza dei materiali di riciclo, il loro dosaggio, il rispetto di alcune peculiarità tecnologiche e il raggiungimento dei parametri stabiliti della norma ISO14021:2002 dell'International Organization for Standardization e del regolamento LEED del U.S. Green Building Council (USGBC).

Per maggiori informazioni: www.bureauveritas.com

Bureau Veritas is the mark that certifies the recycling of the material that goes into the making of a product, by running an inspection on the entire production cycle. Checks and documentation are carried out on the provenance of the recycled material, the quantities used, the observance of certain technological particulars and the achievement of the parameters established by the ISO14021:2002 regulations of the International Organization for Standardization and the LEED regulation of the U.S. Green Building Council (USGBC). For more information: www.bureauveritas.com

Bureau Veritas est une marque qui certifie que le matériau dont un produit est composé a été recyclé, en soumettant l'ensemble du cycle de production à une vérification. La provenance des matériaux recyclés est contrôlée et prouvée, de même que leur dosage et le respect de certaines caractéristiques technologiques et des paramètres définis par la norme ISO14021:2002 de l'Organisation internationale de normalisation et le règlement LEED de l'U.S. Green Building Council (USGBC). Pour plus d'informations : www.bureauveritas.com

Bureau Veritas ist ein Markenzeichen, das die rezyklierte Art des Materials zertifiziert, aus dem ein Produkt besteht und dazu den gesamten Produktionszyklus prüft. Kontrolliert und beurkundet wird die Herkunft der rezyklierten Materialien, deren Dosierung, die Einhaltung einiger technologischer Eigenschaften und das Erreichen der Parameter, die von den Vorschriften ISO14021:2002 der International Organization for Standardization und von den LEED-Vorschriften des U.S. Green Building Council (USGBC) vorgeschrieben werden. Für weitere Infos siehe: www.bureauveritas.com

Bureau Veritas es la marca que certifica la naturaleza reciclada del material con el que está hecho un producto, sometiendo a control todo el ciclo productivo. Se controla y documenta la proveniencia de los materiales reciclados, su dosificación, que se respeten algunas peculiaridades tecnológicas y que se alcancen los parámetros establecidos por la norma ISO14021:2002 de la International Organization for Standardization y del reglamento LEED del U.S. Green Building Council (USGBC). Para más información: www.bureauveritas.com

Бюро Веритас - это сертифицирующий орган, который по итогам аудита и оценки всего производственного цикла выдает сертификат, подтверждающий соответствие качества переработанного сырья, используемого в изготовлении продукции, заданным стандартам. Аудиторами проводится контроль и документирование происхождения переработанного сырья, его дозирования, соблюдения определенных технологических особенностей и наличия реквизитов, установленных стандартом ISO14021:2002 Международной Организации по Стандартизации и регламентом LEED Американского совета по экологическому строительству (U.S. Green Building Council). Дополнительная информация на сайте: www.bureauveritas.com



GREENGUARD Certification is the very first voluntary North American indoor air quality product certification created specifically for commercial building products, this certification requires that products meet stringent chemical emissions requirements for over 360 VOCs, plus a limit on the total of all chemical emissions combined. Products undergo routine monitoring and annual retesting to ensure continued compliance with the GREENGUARD Certification standard.



GREENGUARD GOLD Certification was developed with the specific health sensitivities of children and other vulnerable health populations in mind and based on key criteria from public health agencies, this certification sets some of the world's most stringent emission limits on over 360 chemicals, a limit on total chemical emissions, and a limit on phthalate emissions. Products undergo routine monitoring and annual retesting to ensure continued compliance with the GREENGUARD Gold standard.

GREENGUARD / GREENGUARD GOLD

Per ulteriori informazioni e approfondimenti / For further details and information / Pour approfondir et obtenir de plus amples informations
Für weitere Informationen / Para obtener más información / Дополнительную информацию и подробности вы найдете на сайте:
www.florim.com



I certificati di prova sono disponibili direttamente sui siti Internet dei vari brand, nella sezione Prove Tecniche dedicata alle diverse collezioni. Per ulteriori informazioni e approfondimenti: www.florim.com

The test certificates are available directly on the websites of the various brands, in the Technical Test section dedicated to the different collections. For further details and information: www.florim.com

Les certificats de test de performance sont disponibles directement sur les sites Internet des différentes marques, dans la section Essais Techniques consacrée aux différentes collections. Pour approfondir et obtenir de plus amples informations: www.florim.com

Die Prüfbescheinigungen sind direkt auf den Internetseiten der entsprechenden Brands im Bereich Technische Prüfungen der verschiedenen Kollektionen verfügbar. Für weitere Informationen: www.florim.com

Los certificados de ensayo están disponibles directamente en los sitios internet de las diferentes marcas, en la sección Ensayos Técnicos dedicada a las diferentes colecciones. Para obtener más información: www.florim.com

С испытательными сертификатами на различные марки можно ознакомиться на сайтах в интернете в разделе Технические испытания, охватывающем различные коллекции. Дополнительную информацию и подробности вы найдете на сайте: www.florim.com

Certificazioni di prodotto / Product certifications / Certificats de test de performance / Prüfbescheinigungen / Certificados de ensayo
СЕРТИФИКАТЫ НА ПРОДУКЦИЮ



Marcatura CE / CE Mark / Marquage CE / CE-Kennzeichnung / Marca CE / МАРКИРОВКА CE

Per ulteriori informazioni, approfondimenti e download delle marcature CE: www.florim.com

For further details and information and to download the CE marks: www.florim.com

Pour obtenir de plus amples informations, approfondir et télécharger les marquages CE: www.florim.com

Für weitere Informationen und Downloads der CE-Kennzeichnungen: www.florim.com

Para obtener más información y descargar las marcas CE: www.florim.com

Получить дополнительную, более подробную информацию, а также скачать маркировку CE можно на сайте: www.florim.com



放射性水平 A 类

Certificazione obbligatoria per l'esportazione in Cina. Per ulteriori informazioni e approfondimenti:

Certification mandatory for export to China. For further details and information:

Certification obligatoire pour l'exportation en Chine.

Pour approfondir et obtenir de plus amples informations:

Für den Export nach China obligatorische Zertifizierung. Für weitere Informationen:

Certificación obligatoria para la exportación a China. Para obtener más información:

Обязательная сертификация для экспорта в Китай.

Дополнительную информацию и подробности вы найдете на сайте: www.florim.com



QB-UPEC

Per informazioni relative ai dati tecnici sulla classificazione QB UPEC nella sola versione in lingua francese vedi il sito www.florim.com

Pour toute information concernant les données techniques sur la classification QB UPEC, nous vous prions de bien vouloir consulter la version française du site www.florim.com



U.S. GREEN BUILDING COUNCIL

Florim ha aderito volontariamente all'U.S. Green Building Council (USGBC), la più importante associazione statunitense di industrie appartenenti al settore edilizio, unite per promuovere edifici costruiti in accordo a precise disposizioni riguardanti la sostenibilità ambientale che sono incluse all'interno della certificazione LEED (Leadership in Energy and Environmental Design), un sistema a punteggio che misura la sostenibilità di un progetto. L'utilizzo di prodotti Florim contribuisce a ottenere punti per l'acquisizione della certificazione LEED.

Florim has voluntarily become a member of the U.S. Green Building Council (USGBC), the most important American association dedicated to environmentally sustainable building design and construction according to precise directives, which must be followed in order to obtain LEED (Leadership in Energy and Environmental Design) certification, a rating system that measures the sustainability of a project. Using Florim products contributes to getting points to achieve LEED certification.

Florim a adhéré volontairement à l'U.S. Green Building Council (USGBC), la plus grande association américaine d'industries appartenant à la filière BTP, unies pour promouvoir la réalisation de constructions conformes aux dispositions précises édictées en matière de durabilité environnementale, incluses dans la certification LEED (Leadership in Energy and Environmental Design), un système d'attribution de notes mesurant la durabilité d'un projet. L'utilisation des produits Florim contribue à l'obtention de points en vue de la certification LEED.

Florim ist freiwillig dem U.S. Green Building Council (USGBC) beigetreten, dem bedeutendsten Verband der Bauindustrien in den Vereinigten Staaten, die sich zur Förderung von Gebäuden vereinigt haben, die gewissen Nachhaltigkeitsvorschriften entsprechend gebaut werden. Diese Bestimmungen sind in der LEED-Zertifizierung (Leadership in Energy and Environmental Design), einem Punktesystem zur Bewertung der Nachhaltigkeit eines Projekts, enthalten. Der Gebrauch von Florim Produkten trägt zur Erlangung von Punkten der LEED-Zertifizierung bei.

Florim ha adherido voluntariamente al U.S. Green Building Council (USGBC), la más importante asociación estadounidense de industrias pertenecientes al sector de la construcción, unidas para promover la construcción de edificios de acuerdo con precisas disposiciones relativas a la sostenibilidad ambiental, que están incluidas en la certificación LEED (Leadership in Energy and Environmental Design), un sistema por puntos que mide la sostenibilidad de un proyecto. El uso de productos Florim contribuye a obtener puntos para adquirir la certificación LEED.

Фирма Флорим добровольно вступила в организацию U.S. Green Building Council (USGBC), самая влиятельная североамериканская ассоциация, объединяющая предприятия, занятые в строительной отрасли, для продвижения строительства зданий, отвечающих четким природоохранным требованиям, которые включены в сертификацию LEED (Leadership in Energy and Environmental Design), систему подсчета баллов, измеряющую природосберегающий аспект проекта. Использование продукции Флорим способствует получению баллов для присвоения сертификата LEED.

La certificazione LEED è una certificazione di edificio non di prodotto. Pertanto i criteri LEED fanno sempre riferimento al sistema edificio e non ai singoli materiali utilizzati nel progetto. La soglia indicata nei crediti si riferisce quindi al parametro cui l'edificio dovrà conformarsi per l'attribuzione del relativo punteggio. Sul sito Florim.com all'interno delle certificazioni di ogni singola collezione, è disponibile la Certification Letters for LEED® Projects.

LEED certification is a building certification and not for a product. Therefore, the LEED criteria always refer to the building system and not to the individual building materials used in the project. The threshold indicated in the credits, therefore refers to the parameter to which the building must comply with for the allocation of the corresponding point score. Certification Letters for LEED® Projects are available on the Florim.com website, in the certifications for each single collection.

La certification LEED (« Leadership in Energy and Environmental Design ») est une certification qui concerne les bâtiments et non pas les produits. Ainsi, les critères LEED font toujours référence au système bâtiment et non pas aux matériaux utilisés dans le projet. Le seuil indiqué dans les crédits se réfère donc au paramètre auquel le bâtiment devra se conformer pour l'attribution des points correspondants. Sur le site Florim.com, parmi les certifications de chaque collection, la Certification Letters for LEED® Projects est disponible.

Bei der LEED-Zertifizierung handelt es sich nicht um ein Produkt- sondern ein Gebäudezertifizierungssystem. Daher beziehen sich die LEED-Kriterien immer auf das Gebäude im Ganzen, nicht auf die einzelnen für das Projekt verwendeten Materialien. Der für die Punkte angegebene Grenzwert bezieht sich daher auf den Wert, den das Gebäude einhalten muss, um die entsprechenden Punkte zu erhalten. Auf der Website Florim.com finden sich in den Zertifizierungen der einzelnen Kollektionen die Certification Letters for LEED® Projects.

La certificación LEED es una certificación para el edificio y no para el producto. Por lo tanto los criterios LEED siempre se refieren al sistema edificio y no a cada uno de los materiales utilizados en el proyecto. El umbral indicado en los créditos se refiere por lo tanto al parámetro al cual el edificio se deberá ajustar para que le sea atribuida la correspondiente puntuación. En el sitio web Florim.com, en la sección de las certificaciones de cada colección, están disponibles las Certification Letters for LEED® Projects.

Сертификация LEED – это сертификация зданий, а не продукта. Таким образом, критерии LEED распространяются на систему здания в целом, а не на отдельные строительные материалы, используемые в реализации проекта. Следовательно, указанное в системе оценки пороговое значение относится к параметру, которому должно соответствовать здание для получения определенного количества баллов. На сайте Florim.com, среди сертификатов, выданных для каждой отдельной коллекции, можно найти сертификационные письма на проекты LEED®.



SGBP 2018-1991

Il Green Building Council di Singapore crea partnership pubblico-privato per promuovere soluzioni di settore innovative attraverso l'intera catena del valore degli edifici e della costruzione. Attraverso i suoi prodotti di bioedilizia e i programmi di etichettatura dei servizi di edilizia ecologica, SGBC stabilisce standard elevati e parametri di riferimento per le soluzioni di bioedilizia sia a livello locale che regionale per aiutare a costruire città più sostenibili per una vita migliore. In qualità di rappresentante di Singapore nel World Green Building Council, SGBC contribuisce attivamente al movimento globale di bioedilizia condividendo competenze e conoscenze durante conferenze ed eventi internazionali.

The Singapore Green Building Council forges public-private partnerships to foster innovative industry solutions across the entire building and construction value chain. Through its green building product and green building services labelling programmes, SGBC sets high standards and benchmarks for green building solutions both locally and regionally to help build more sustainable cities for better living. As Singapore's representative on the World Green Building Council, SGBC actively contributes to the global green building movement by sharing expertise and knowledge during international conferences and events.



ENVIRONMENTAL PRODUCT DECLARATION

L'EPD è una Dichiarazione Ambientale di Prodotto certificata e verificata in modo indipendente, che esprime in modo trasparente e oggettivo le prestazioni ambientali di un prodotto lungo il suo ciclo di vita, in accordo con lo Standard internazionale ISO14025.

L'EPD è basata su specifiche regole che ne definiscono le metodologie di calcolo: le Product Category Rules (PCR), e non prevede soglie prestazioni.

The EPD is a certified and independently verified Environmental Product Declaration that expresses in a transparent and objective manner the environmental performance of a product throughout its life cycle, in accordance with the International Standard ISO14025.

The EPD is based on specific rules that define the calculation methodologies: the Product Category Rules (PCR), and does not provide for performance thresholds.

La DEP est une Déclaration Environnementale de Produit certifiée et vérifiée de façon indépendante, décrivant de manière transparente et objective les performances environnementales d'un produit tout au long de son cycle de vie, conformément à la norme internationale ISO 14025.

La DEP s'appuie sur des règles spécifiques qui définissent ses méthodes de calcul : les Product Category Rules (PCR), et ne prévoit pas de seuils de performance.

EPD ist eine zertifizierte und unabhängig kontrollierte Produkt-Umwelterklärung, die, übereinstimmend mit der internationalen Norm ISO14025, auf transparente und objektive Weise die Umweltleistungen eines Produkts während seines Lebenszyklus bekundet.

EPD basiert auf spezifischen Regeln, die die Berechnungsmethode festlegen: die Product Category Rules (PCR), die keine Leistungsschwellen vorsehen.

La DAP es una declaración ambiental de producto, certificada y verificada de manera independiente, que informa acerca del desempeño ambiental de un producto a lo largo de su ciclo de vida de forma transparente y objetiva, de conformidad con la norma internacional ISO 14025.

La DAP se basa en reglas específicas que definen sus métodos de cálculo, denominadas Reglas de categoría de producto (RCP), y no prevé umbrales de desempeño.

EPD - это экологическая декларация продукции, сертифицированная и проверенная независимой организацией, которая понятно и объективно документирует воздействие продукции на окружающую среду в течение ее жизненного цикла, в соответствии с международным стандартом ISO 14025.

Декларация EPD не предусматривает предельные характеристики и основана на специальных правилах, определяющих методы расчета, которые известны под названием правила по категориям продукции (Product Category Rules, PCR).

- Il ciclo di produzione delle lastre ceramiche Florim è completato da una cottura ad alta temperatura (fino a 1250 °C a seconda del prodotto); a tali temperature si verificano reazioni chimico-fisiche tra il supporto della lastra e lo smalto superficiale (dove presente) che portano alla formazione di una struttura fortemente compatta, dura e resistente.
 - Nelle normali condizioni di utilizzo di lastre ceramiche Florim, qualsiasi fenomeno che riguarda la dispersione di metalli nell'ambiente è assolutamente da escludere; inoltre, anche nelle più estreme condizioni di lavoro, la rimozione di materiale dalla superficie delle lastre come risultato di abrasione è di fatto trascurabile. In ogni caso, qualsiasi tipo di materiale asportato dalle piastrelle è inerte dal punto di vista tossicologico, non ha impatto sull'ambiente e la sua dispersione non comporta alcun effetto.
 - Il risultato di studi specifici ha evidenziato che il livello di radioattività naturale in questi materiali non è fonte di potenziali problemi per le persone che vivono in ambienti pavimentati o rivestiti con piastrelle.
 - Le lastre ceramiche Florim sono completamente inerti al fuoco (ad esclusione del gres porcellanato decorato). Non rischiano quindi di subire danneggiamenti in caso di esposizione a fiamme libere e non contribuiscono all'intensificazione e propagazione del fuoco. Non rilasciano sostanze tossiche, gas o fumi di alcun tipo e, in caso di incendio, apportano una significativa protezione alle strutture sulle quali sono applicate, riducendo fortemente lo stress termico alle quali sono sottoposte.
 - Le lastre ceramiche Florim non costituiscono una base per la proliferazione di batteri e il loro utilizzo è indicato per luoghi in cui le condizioni di sterilità devono essere facilmente mantenute.
 - I detriti provenienti dalla demolizione delle lastre ceramiche sono materiali inerti (non reattivi, chimicamente e fisicamente stabili, resistenti all'esposizione prolungata a condizioni estreme dal punto di vista termico, igrometrico e chimico); tali detriti possono essere collocati nell'ambiente senza rischi particolari e trovare impiego anche nella preparazione di sottofondi, ecc.
 - Istruzioni per l'installazione: "Nelle operazioni di posa si raccomanda il taglio a umido o il metodo ad incisione e spacco. Evitare di utilizzare utensili per il taglio a secco durante l'installazione. Tecniche di posa improprie possono esporre il posatore a polveri dannose".
-
- The Florim ceramic slab production cycle is completed by firing at high temperature (up to 1250°C depending on the product); at these temperatures chemical-physical reactions occur between the slab body and the surface glaze (if applied) that result in the formation of a highly compact, hard and resistant structure.
 - Under normal conditions of use of the Florim ceramic slabs, any phenomenon of metal dispersion into the environment is absolutely excluded; what is more, even in the most extreme operating conditions, material coming off the slab surface as a result of abrasion is negligible. In any event, any type of material removed from the tiles is inert from a toxicological point of view, has no impact on the environment and its dispersion has no effect at all.
 - The results of specific studies have pointed out that the level of natural radioactivity in these materials is not a source of potential risk for persons that live in houses where floor and wall tiles are laid.
 - The Florim ceramic slabs (not applicable to decorated gres porcelain) are 100% fire-inert and there is hence no risk of damage in the event of exposure to naked flames and they do not contribute to fire intensification and propagation. They do not release toxic substances, gases or fumes of any kind and, in case of fire, provide considerable protection to the structures on which they are applied, strongly reducing the thermal stress to which they are subjected.
 - The Florim ceramic slabs do not constitute a base for proliferation of bacteria and they are suitable for use in places where it must be easy to maintain sterile conditions.
 - The debris resulting from ceramic slab demolition is inert (unreactive, chemically and physically stable, resistant to prolonged exposure to extreme conditions from the thermal, hygrometric and chemical point of view) and can be disposed of in the environment without any particular risk, as well as finding use in the preparation of foundations, etc.
 - Installation Instructions: "We recommend wet cutting or the score and snap method during the installation process. Do not dry cut using power tools during the installation process. Improper installation techniques could expose installer to harmful dust".
-
- Le cycle de fabrication des dalles en céramique Florim est complété par une cuisson à température élevée (jusqu'à 1250°C selon le produit). C'est à cette température qu'ont lieu les réactions physico-chimiques entre le tesson de la dalle et l'émail de surface (s'il est appliqué), aboutissant à la formation d'une structure particulièrement compacte, dure et résistante.
 - Dans des conditions normales d'utilisation des dalles en céramique Florim, tout phénomène de dispersion des métaux dans l'environnement est absolument exclu. De plus, même dans des conditions extrêmes de travail, le retrait de matière dû à l'abrasion qui se produit à la surface des dalles est parfaitement négligeable. Le type de matière enlevée est inerte du point de vue toxicologique, il n'a pas d'impact sur l'environnement et sa dispersion n'entraîne aucun effet.
 - Des études spécifiques ont montré que le niveau de radio-activité naturelle dans ces matériaux ne représentait pas une source de problèmes potentiels pour les personnes vivant dans des pièces dont les sols ou les murs sont recouverts de carreaux céramiques.
 - Les dalles céramiques Florim sont totalement inertes au feu (en excluant le grés cérame décoré). Elles ne risquent donc pas de subir de détérioration en cas d'exposition à des flammes nues et ne contribuent ni à l'intensification ni à la propagation de l'incendie. Elles ne dégagent pas de substances toxiques, gaz ou fumées, de quelque type que ce soit, et, en cas d'incendie, elles constituent une protection significative des structures sur lesquelles elles sont appliquées et réduisent considérablement le choc thermique auquel elles sont soumises.
 - Les dalles céramiques Florim ne sont pas une base de prolifération des bactéries et leur utilisation est indiquée dans les locaux où le maintien de conditions de stérilité doit être obtenu simplement.
 - Les débris provenant de la démolition des dalles céramiques sont des matériaux inertes (non réactifs, chimiquement et physiquement stables, résistant à l'exposition prolongée à des conditions extrêmes du point de vue thermique, hygrométrique et chimique). Ces débris peuvent être déposés dans l'environnement sans risques particuliers et ils peuvent aussi être utilisés pour la préparation de sous-couches etc.
 - Instructions d'installation: "Pendant les opérations de pose nous recommandons pour couper le carreau la découpe à l'eau ou la méthode de l'incision sur le carreau. Pendant les opérations de pose ne pas découper à l'aide d'outils électriques. Les techniques d'installation inadéquates pourraient exposer le carreleur à des poussières nuisibles pour la santé".

- Der Produktionsablauf der Florim Keramikplatten wird durch das Brennen bei hoher Temperatur (bis zu 1250 °C je nach Produkt) vervollständigt; bei diesen Temperaturen treten physikochemische Reaktionen zwischen der Unterlegplatte und der (eventuell vorhandenen) oberflächlichen Glasur ein, die zur Bildung einer sehr kompakten, harten und widerstandsfähigen Struktur führen.
- Bei normalen Gebrauchsbedingungen der Florim Keramikplatten ist jegliche Erscheinung hinsichtlich der Feinverteilung von Metallen absolut ausgeschlossen. Auch bei äußerst extremen Arbeitsbedingungen ist der Abrieb der Plattenoberflächen ganz unbedeutend. Jede Art Material, das von den Fliesen abgetragen wird, ist ungiftig und umweltneutral und seine Zerstreuung hat keine Auswirkungen.
- Spezielle Studien haben ergeben, dass der Pegel der natürlichen Radioaktivität dieser Materialien keine Quelle potentieller Gesundheitsstörungen für die Menschen, die in Räumen mit Boden- und Wandbelägen aus Fliesen leben, darstellt.
- Die Florim Keramikplatten sind vollkommen feuerbeständig (ausgenommen das mit Kaltglasur dekorierte Feinsteinzeug). Es besteht also keine Gefahr, dass sie sich, falls sie freien Flammen ausgesetzt werden, beschädigen und sie tragen nicht zur Verstärkung und Ausbreitung des Feuers bei. Sie geben keine giftigen Substanzen, irgendwelche Gase oder Dünste ab und im Falle eines Brandes bieten sie einen erheblichen Schutz der Strukturen, an denen sie angebracht sind, und verringern stark deren Hitzeschock.
- Die Florim Keramikplatten stellen keinen Boden für die Vermehrung von Bakterien dar und ihr Gebrauch ist an allen Stellen angezeigt, wo es erforderlich ist, leicht die Bedingungen der Sterilität aufrechtzuerhalten.
- Der durch den Abbruch der Keramikplatten verursachte Schutt besteht aus trägen (nicht reaktionsfähigen) Materialien, die chemisch und physikalisch stabil sowie widerstandsfähig gegenüber der langen Exposition unter extremen Bedingungen in thermischer, hygrometrischer und chemischer Hinsicht sind. Dieser Schutt kann ohne besondere Risiken im Freien platziert oder auch zur Vorbereitung von Untergründen usw. verwendet werden.
- Installationsanleitung: "Wir empfehlen das Nassschneiden oder schneiden mit Fliesenschneider während des Installationsvorgangs. Während der Installation nicht mit Flex arbeiten. Unsachgemäße Installationstechniken können dem Installateur schädlichen Staub zufügen."

- El ciclo de producción de las losas cerámicas Florim se completa con una cocción a alta temperatura (hasta 1250 °C en función del producto); a dichas temperaturas se verifican reacciones químico-físicas entre el soporte de la losa y el esmalte superficial (si estuviera presente) que llevan a la formación de una estructura fuertemente compacta, dura y resistente.
- En condiciones de uso normales de las losas cerámicas Florim, debe excluirse cualquier fenómeno concerniente a la dispersión de metales en el ambiente; además, incluso en las condiciones de trabajo más extremas, la pérdida de material de la superficie de las losas debido a la abrasión es, de hecho, del todo insignificante. Como quiera que sea, cualquier tipo de material procedente de las losas es inerte desde el punto de vista toxicológico, no tiene ningún impacto en el ambiente y su dispersión no comporta ningún efecto.
- Estudios específicos han demostrado que el nivel de radiactividad natural en estos materiales no es una fuente de potencial peligro para las personas que viven en ambientes pavimentados o revestidos con azulejos.
- Las losas cerámicas Florim son completamente inertes al fuego (excluido el gres porcelánico decorado). Por lo tanto, en caso de exposición a llamas libres no sufren daños y no contribuyen a la intensificación y a la propagación del fuego. Además, no emiten sustancias tóxicas, gases o humos de ningún tipo y, en caso de incendio, aportan una significativa protección a las estructuras en las que están aplicadas y reducen fuertemente el estrés térmico al cual están sometidas.
- Las losas cerámicas Florim no constituyen una base para la proliferación de bacterias, siendo indicadas para aquellos lugares que requieren unas condiciones de esterilidad fáciles de mantener.
- Los residuos procedentes de la demolición de las losas cerámicas son materiales inertes (no reactivos, químicamente y físicamente estables, resistentes a la exposición prolongada a condiciones extremas desde el punto de vista térmico, higrométrico y químico); dichos residuos pueden colocarse en el ambiente sin riesgos especiales y también pueden utilizarse en la preparación de subcapas, etc.
- Instrucciones de instalación: "Se recomienda el corte húmedo o el método de incisión y división durante las operaciones de colocación. Evite usar herramientas de corte en seco durante la instalación. Las técnicas de colocación inadecuadas pueden exponer al instalador a polvo nocivo".

- Цикл производства керамических плит Флорим завершается обжигом при высокой температуре (до 1250°C в зависимости от продукта), при таких температурах происходят физико-химические реакции между основой плиты и поверхностной глазурью (где она присутствует), которые приводят к образованию сверхкомпактной, твердой и прочной структуры.
- При нормальных условиях использования керамических плит Флорим любые явления, связанные с распылением металлов в окружающей среде, абсолютно исключаются; кроме того, даже при самых экстремальных рабочих условиях удаление материала с поверхности плит в результате стирания фактически ничтожны. В любом случае, материал, снятый с поверхности плитки, является абсолютно инертным с точки зрения токсикологии, не оказывает воздействия на окружающую среду, и его распыление не имеет никакого эффекта.
- Результат специальных исследований показал, что уровень естественной радиоактивности в этих материалах не является источником потенциальных проблем для людей, живущих в помещениях, в которых пол и стены покрыты плиткой.
- Керамические плиты Флорим полностью инертны к огню (за исключением декорированного керамогранита). Таким образом, отсутствует риск их повреждения в случае контакта с открытым пламенем, и они не способствуют усилению и распространению огня. Эти плиты не выделяют токсических веществ, газа или дымов любого типа, а в случае пожара значительно защищают структуры, на которые они нанесены, резко сокращая температурный стресс, которому они при этом подвержены.
- Керамические плиты Флорим не представляют собой основы для распространения бактерий, и их применение рекомендовано для помещений, в которых условия стерильности должны поддерживаться без затруднений.
- Отходы, образующиеся при уничтожении керамической плитки, являются инертным материалом (нерактивные, химически и физически стабильны, устойчивы к продолжительному воздействию экстремальных условий с точки зрения температуры, влажности и химической среды), такие отходы могут быть размещены в окружающей среде без особых рисков, а также найти применение в приготовлении подстилающих слоев и т.д.
- Инструкция по укладке: При выполнении операций по укладке рекомендуется выполнять резку материала влажным методом или методом надреза с последующим разломом. Во время укладки материала не пользуйтесь инструментом для резки всухую. В случае использования несоответствующей технологии вредная пыль может попасть в дыхательные пути плиточника.

Su richiesta possono essere forniti logotipi personalizzati, grafiche particolari e motivi decorativi ottenuti con taglio ad acqua. Ad ogni richiesta farà seguito il preventivo e saranno comunicati i termini di consegna.

Upon request we can supply personalized logos, patterns and decorated accents obtained by water jet cuttings. For each request, we shall supply an estimate and confirm the delivery time.

Nous pouvons fournir sur demande des logos, et des motifs obtenus par jets d'eau. Pour chaque demande nous faisons suivre une devis délais de livraison.

Auf Wunsch erhalten Sie Dekormotive; personalisierte Firmenlogos, und Sondergrafik mit Wasserstrahlen. Jede Anfrage bekommt einen Kostenvoranschlag sowie, falls eine Bestellung erteilt wird, die vorhandenen Lieferzeiten.

A solicitud, se pueden facilitar logotipos personalizados, dibujos gráficos particulares y motivos decorativos cortados con chorro de agua. Al recibir el pedido, comunicaremos a nuestros clientes el presupuesto junto a los plazos de entrega.

По заказу поставляются индивидуальные логотипы, специальная графика и декоративные мотивы, получаемые резкой струей воды под давлением. По каждому заказу будет составляться смета и будут указываться сроки поставки.



CONDIZIONI GENERALI DI VENDITA

GENERAL CONDITIONS OF SALE
CONDITIONS GÉNÉRALES DE VENTE
ALLGEMEINE GESCHÄFTSBEDINGUNGEN
CONDICIONES GENERALES DE VENTA
ОБЩИЕ УСЛОВИЯ ПРОДАЖИ

CONDIZIONI GENERALI DI VENDITA

1 NORMATIVA CONTRATTUALE

Le presenti condizioni generali, salvo modificazioni o deroghe concordate per iscritto, disciplinano tutti i contratti di vendita fra Florim Ceramiche S.p.A. SB e l'Acquirente senza che sia necessario un espresso richiamo a esse. Le variazioni delle condizioni generali di vendita, le offerte, gli accordi o gli abbuoni accordati dai nostri agenti o altri intermediari, non sono validi se non accettate per iscritto dalla nostra sede.

2 OGGETTO DELLA FORNITURA

La fornitura comprende solamente i materiali, le prestazioni ed i quantitativi specificati nella nostra conferma d'ordine. Il testo della conferma d'ordine Florim Ceramiche S.p.A. SB prevarrà in ogni caso sul testo difforme della eventuale offerta o della ordinazione.

3 CONFERMA D'ORDINE

Qualora nella conferma d'ordine Florim Ceramiche S.p.A. SB esistano differenze nei singoli elementi che la compongono rispetto alle intese od alle ordinazioni, l'Acquirente che non abbia contestato per iscritto entro 7gg dalla ricezione della nostra conferma s'intende che l'abbia accettata così come è stata redatta. Il cliente si impegna a comunicare a Florim Ceramiche S.p.A. SB l'eventuale variazione del luogo di destinazione della merce, se diverso da quello citato nella conferma d'ordine, entro e non oltre il giorno previsto per il ritiro presso Florim Ceramiche S.p.A. SB, mediante invio, tramite posta e-mail, dei dati identificativi del destinatario delle merci e del luogo presso il quale dovrà essere effettuata la consegna. In mancanza di tale comunicazione la destinazione originariamente indicata si intende tacitamente confermata.

4 PREZZI

I prezzi indicati sui listini Florim Ceramiche S.p.A. SB non sono impegnativi: di conseguenza ci riserviamo il diritto di modificarli prima dell'accettazione dell'ordine. I prezzi pattuiti per ogni singola vendita si intendono al netto, per contanti per consegna franco stabilimento, salvo diversa pattuizione scritta. Se fra la data di ordinazione (anche dopo la conferma d'ordine) e quella di consegna si verificassero aumenti nei costi delle materie prime, della manodopera, dei combustibili, nelle spese di produzione, di trasporto ecc., e in caso di variazione rilevante dei tassi di cambio tra divisa di fatturazione e divisa interna, Florim Ceramiche S.p.A. SB potrà aumentare il prezzo convenuto dandone comunicazione scritta all'Acquirente anche a mezzo posta elettronica. Tuttavia, qualora detto prezzo superi del 20% quello convenuto al momento dell'ordinazione, l'Acquirente potrà recedere dal contratto notificandoci per raccomandata tale sua volontà entro il termine perentorio di 10 gg dal ricevimento dell'avviso dell'aumento di prezzo. In difetto, il nuovo prezzo s'intenderà accettato.

5 CONSEGNE

La vendita, salvo diversa pattuizione scritta, è sempre franco stabilimento di Florim Ceramiche S.p.A. SB. La merce viaggia a rischio e pericolo dell'Acquirente ed ogni nostra responsabilità cessa con la consegna al vettore, nei confronti del quale l'Acquirente, effettuate le opportune verifiche, dovrà sporgere eventuali reclami. Le spedizioni, via mare o via terra, concernenti forniture sull'estero, vengono effettuate in base alle condizioni scelte di volta in volta, riportate negli "Incoterms" approvati dalla Camera di Commercio Internazionale.

6 TERMINI DI CONSEGNA

I termini di consegna hanno carattere indicativo: eventuali ritardi nelle consegne, interruzioni, sospensioni totali o parziali delle forniture non daranno diritto ad indennizzi o risarcimento danni se non diversamente concordato per iscritto.

7 CAMPIONI

I dati figuranti nei documenti illustrativi di Florim Ceramiche S.p.A. SB, così come le caratteristiche dei campioni e i modelli da quest'ultimo inviati all'Acquirente, hanno carattere di indicazioni approssimative. Questi dati non hanno valore impegnativo se non nella misura in cui siano stati espressamente menzionati come tali nell'offerta o nell'accettazione scritta di Florim Ceramiche S.p.A. SB.

8 PAGAMENTI

Le fatture di Florim Ceramiche S.p.A. SB possono essere emesse il giorno della fornitura, a cadenza quindicinale o mensile e devono essere pagate al netto alla scadenza pattuita. Ogni e qualsiasi obbligazione di pagamento tra le parti contraenti deve essere adempiuta presso la sede della Florim Ceramiche S.p.A. SB. Eventuali pagamenti fatti ad agenti, rappresentanti o ausiliari di commercio di Florim Ceramiche S.p.A. SB non si intendono effettuati finché le relative somme non pervengano a Florim Ceramiche S.p.A. SB. Il pagamento dovrà essere effettuato, salvo diverso accordo scritto, contestualmente alla consegna, presso l'istituto bancario indicato di Florim Ceramiche S.p.A. SB. Qualsiasi ritardo o irregolarità nel pagamento dà a Florim Ceramiche S.p.A. SB il diritto di sospendere le forniture o di risolvere i contratti in corso, anche se non relativi ai pagamenti in questione, nonché il diritto al risarcimento degli eventuali danni. Florim Ceramiche S.p.A. SB ha comunque diritto – a decorrere dalla scadenza del pagamento, senza necessità di messa in mora – agli interessi moratori nella misura prevista dal d.lgs. 09/10/2002 n. 231. In caso d' inadempimento, anche solo parziale, gli interessi moratori sull'importo non pagato decorrono dal giorno della consegna anche se il termine di pagamento era stato convenuto a data successiva. Nessuna contestazione o controversia inerente alla qualità della merce, a vizi o difetti, o a qualsiasi altro aspetto del contratto, sarà efficace e potrà essere presa in considerazione, e così pure nessuna azione potrà essere iniziata se non dopo l'aver avuto integrale pagamento del prezzo (clausola solve et repute). Non è ammessa compensazione con eventuali crediti, comunque insorti, nei confronti di Florim Ceramiche S.p.A. SB.

9 GARANZIE E RECLAMI

La qualità del materiale ceramico è definita sulla base delle vigenti normative internazionali applicabili alla corrispondente classe di prodotto. Florim Ceramiche S.p.A. SB garantisce la sola merce fornita in prima scelta. Reclami relativi a merce in scelta differente dalla prima (scelta B, commerciale, seconda, terza, secondaria, stock, etc.) non saranno presi in considerazione, né viene data implicitamente od esplicitamente alcun tipo di garanzia su tali materiali. È fatto obbligo all'Acquirente di verificare la merce in termini di qualità e quantità entro breve tempo dal ricevimento in caso di reclamo (viaggi, perizie, ecc.). L'obbligo di Florim Ceramiche S.p.A. SB è, in ogni caso, limitato alla sostituzione dei soli pezzi difettosi o alla riparazione, con esplicita esclusione di ulteriori diversi indennizzi quali, a titolo indicativo ma non limitativo, per costi di rimozione e sistemazione di mobili, attrezzature, macchinari ecc., mancati guadagni per interruzione o sospensione di attività, disagi, danni indiretti ecc.. La presenza di piastrelle difettose non inficia la qualità dell'intera fornitura né comporta l'obbligo della integrale sostituzione. I limiti temporali della durata della garanzia sono quelli stabiliti dal codice civile italiano.

10 RISERVATO DOMINIO

La vendita della merce viene effettuata con la clausola del riservato dominio; pertanto, nel caso in cui il pagamento, per accordi contrattuali, debba essere effettuato tutto o in parte dopo la consegna, i prodotti consegnati restano di proprietà Florim Ceramiche S.p.A. SB fino all'integrale pagamento del prezzo.

11 CESSIONE DEL CONTRATTO

L'Acquirente non può cedere la sua posizione nel contratto od in singoli rapporti obbligatori da questo derivanti senza l'accettazione scritta di Florim Ceramiche S.p.A. SB: anche in tal caso l'Acquirente rimane comunque solidalmente responsabile col cessionario per le obbligazioni cedute.

12 PROPRIETA' INDUSTRIALE E DISTRIBUZIONE SELETTIVA - LIMITI ALLA RIVENDITA

Florim Ceramiche S.p.A. SB è titolare e legittimo detentore di esclusive relative ai marchi, a disegni e brevetti di invenzione. Al fine di garantire al meglio il rispetto dei diritti esclusivi di Florim Ceramiche S.p.A. SB, nonché le aspettative dei consumatori finali in ordine alle caratteristiche qualitative attese, Florim Ceramiche S.p.A. SB gestisce le forniture dei propri prodotti mediante un sistema di distribuzione selettiva. Le forniture ricevute da Florim Ceramiche S.p.A. SB e dai propri punti vendita selettivi autorizzati sono destinate all'installazione presso l'utente finale e non è consentita altra forma di rivendita a ulteriori intermediari commerciali diversi dagli utenti finali, salvo previa autorizzazione scritta da parte di Florim Ceramiche S.p.A. SB. La rivendita della merce in violazione di tale divieto deve considerarsi pertanto non consentita ed equiparata ad uso illecito dei diritti di proprietà industriale e intellettuale di Florim Ceramiche S.p.A. SB, con diritto di Florim Ceramiche S.p.A. SB di chiederne il sequestro presso qualunque detentore. Florim Ceramiche S.p.A. SB si riserva il diritto di procedere giudizialmente nei confronti di chiunque sia coinvolto in rivendite non autorizzate.

13 LEGGE DEL CONTRATTO - FORO COMPETENTE

Il contratto è disciplinato dalla legge italiana, competendo gli Usi di settore della Provincia di Modena. Per qualsiasi controversia comunque derivante dal contratto di fornitura, tanto da parte di Florim Ceramiche S.p.A. SB come da parte dell'Acquirente, è esclusivamente competente il Tribunale di Modena. E comunque in facoltà di Florim Ceramiche S.p.A. SB adire forti concorrenti o alternativi.

14 SICUREZZA DELLA CATENA LOGISTICA

Florim Ceramiche S.p.A. SB al fine di garantire la sicurezza della catena logistica internazionale richiede ai propri CLIENTI il rispetto di requisiti standard per garantire la sicurezza delle merci nei rapporti contrattuali e per garantire la loro conformità alla normativa AEO - Operatore Economico Autorizzato - Dogane, in tutta la Comunità Europea. I CLIENTI di Florim Ceramiche S.p.A. SB si impegnano a garantire che le merci prese in consegna o consegnate siano spedite o trasportate, immagazzinate, preparate e caricate in locali sicuri e in zone di carico e di spedizione sicure, protette contro manomissioni non autorizzate, utilizzando solo personale interno autorizzato ed opportunamente istruito.

Tutti gli articoli di questo listino sono venduti esclusivamente a scatole complete.

IL PRESENTE LISTINO ANNULLA E SOSTITUISCE I PRECEDENTI

GENERAL CONDITIONS OF SALE

1 CONTRACTUAL REGULATIONS

These general conditions, subject to modifications or waivers agreed in writing, govern all sales contracts between Florim Ceramiche S.p.A. SB and the Purchaser without the need for an express reference to them. Variations in the general conditions of sale, offers, credits or allowances agreed by our agents or other intermediaries, are not valid unless accepted in writing by our head office.

2 SUBJECT OF THE SUPPLY

The supply includes only the materials, services and quantities specified in our order confirmation. The text of the Florim Ceramiche S.p.A. SB order confirmation shall prevail in any case over any differing text of the offer or order.

3 ORDER CONFIRMATION

If, in the Florim Ceramiche S.p.A. SB order confirmation, there are differences in the individual elements comprising it, compared with the agreements or the orders, the Purchaser is understood to have accepted our confirmation as it was drawn up, unless an objection to it is made in writing within 7 days of receipt of it. The customer undertakes to notify Florim Ceramiche S.p.A. SB of the place of destination of the goods, if different from the address quoted on the order confirmation. In the case of any variation in the place of destination, the identification data of the destination address for the goods and the place where delivery is to be made must be sent by post or email, before the day laid down for collection at Florim Ceramiche S.p.A. SB's premises. If no notification is received, the destination originally shown shall be understood as tacitly confirmed.

4 PRICES

The prices shown in the Florim Ceramiche S.p.A. SB price-lists are not binding; we therefore reserve the right to modify them before acceptance of the order. The prices agreed upon for each individual sale are understood as net, for cash and for delivery ex-works, subject to any different written stipulation. If there should be increases in costs of raw materials, labour, fuel, production or transport costs, etc. and in the event of a significant change in the exchange rates between the billing currency and the local currency, between the order date (even after the order confirmation) and the delivery date, Florim Ceramiche S.p.A. SB may increase the agreed price, giving written notification to the Purchaser also by email. However, if this price should exceed the price agreed at the time of order by 20%, the Purchaser may withdraw from the contract by notifying us by registered letter of his desire to do so within the deadline of 10 days from receipt of the notice of price increase. If he fails to do so, the price shall be understood as accepted.

5 SHIPMENTS

The sale is always ex-works at the Florim Ceramiche S.p.A. SB premises, unless otherwise agreed in writing. The goods travel at the Purchaser's risk and our liability ends with delivery to the carrier, to whom the Purchaser after performing suitable checks must make any claims that may arise. Shipments by sea or land concerning supplies carried out abroad are performed according to conditions chosen on a time-by-time basis, shown in the "Incoterms" approved by the International Chamber of Commerce.

6 DELIVERY TIMES

Delivery times are by way of indication only; any delays in delivery and interruptions and total or partial suspensions of supplies shall not give rise to an entitlement to refunds or claims for compensation unless otherwise agreed in writing.

7 SAMPLES

The data shown in the Florim Ceramiche S.p.A. SB illustrative documents, as well as the characteristics of samples and models sent by Florim Ceramiche S.p.A. SB to the Purchaser, is of an approximately indicative nature. This data has no binding value except to the extent to which they were expressly mentioned as such in Florim Ceramiche S.p.A. SB's offer or written acceptance.

8 PAYMENTS

Florim Ceramiche S.p.A. SB's invoices can be issued on the day of supply, fortnightly or monthly and must be paid net on the agreed expiry date. Each and every obligation for payment between the contracting parties must be performed at Florim Ceramiche S.p.A. SB's head office. Any payments made to agents, sales representatives or assistants of Florim Ceramiche S.p.A. SB are not considered to have been carried out until the relative sums have reached Florim Ceramiche S.p.A. SB. Payment must be carried out, subject to any other written agreement, at the same time as the delivery; to the bank indicated by Florim Ceramiche S.p.A. SB. Any delay or irregularity in payment gives Florim Ceramiche S.p.A. SB the right to suspend supplies or to terminate current contracts, even if they do not relate to the payments in question, as well as the right to claim any damages. Florim Ceramiche S.p.A. SB is in any case entitled – starting from the payment expiry date, and without the need for notice of default – to the interest on arrears to the extent provided for by Italian Legislative Decree No. 231 of 09/10/2002. In the case of non-fulfilment, even only partial, the interest on arrears for the unpaid amount shall start from the day of delivery even if the payment term was agreed on as a later date. No objection or dispute referring to the quality of the goods or to flaws or defects or to any other aspect of the contract shall be valid and can be taken into consideration; in addition, no action may be started up until after payment has been made of the entire amount of the price (solve et repute clause). Compensation to Florim Ceramiche S.p.A. SB, with any credits, however they may have arisen, is not permitted.

9 GUARANTEES AND COMPLAINTS

The quality of the ceramic material is defined on the basis of the prevailing international regulations applicable to the corresponding product class. Florim Ceramiche S.p.A. SB guarantees only goods supplied as prime quality. Complaints relating to goods other than of prime quality ("B" quality, commercial, second, third, secondary, stock, etc.) shall not be taken into consideration, nor will any kind of guarantee be given, either implicitly or explicitly, on these materials. The Purchaser is obliged to check the goods in terms of quality and quantity within a short time after receipt and, in the case of a complaint, to give notification of this in writing no later than 8 (eight) days from receipt of the goods; failure to do so will incur the forfeiture of all rights. Material deemed to be defective must be held at Florim Ceramiche S.p.A. SB's disposal for the checks that it will consider suitable to carry out; any further action (return, repair or other) must be authorized in advance by us in writing. Complaints and requests for intervention under guarantee after the material has been laid shall not be taken into account if the defect reported is evident (e.g. chips, defects of size, differences in colour shade, etc.) it is made clear that the prime quality may contain defective tiles up to a limit of 5% and that the colour shades of the material supplied may differ from the sample displayed, since ceramic is intrinsically variable in appearance. Complaints attributed to latent flaws or defects must be formalized in writing within 8 (eight) days from their discovery and, in any case, within one year from delivery; failure to do so will incur the forfeiture of all rights under the guarantee and to compensation. As well as the invoice details, the notification must contain a precise description of the defect and an estimate of costs for repair or modification of the product; failure to notify this data will cause the complaint to be deemed invalid. If the complaint should prove to be unfounded the Purchaser must reimburse Florim Ceramiche S.p.A. SB for all the expenses incurred for assessment (travelling expenses, surveys, etc.). Florim Ceramiche S.p.A. SB's obligation is, in any case, limited to replacing the defective pieces only or to repairing them, with the express exclusion of other, further indemnities such as, by way of a non-limiting example, for costs of removing and re-installing furniture, equipment, machinery, etc., or loss of earnings for interruption or suspension of business, inconvenience, consequential damages, etc. The presence of defective tiles does not invalidate the quality of the entire supply, nor does it incur the obligation for its entire replacement. The time limits for the duration of the guarantee are as established by the Italian Civil Code.

10 RETENTION OF TITLE

Sale of the goods is carried out with the retention of title clause; therefore if payment, by contractual agreements, must be carried out wholly or in part after delivery, the products delivered remain the property of Florim Ceramiche S.p.A. SB until the entire price has been paid.

11 TRANSFER OF CONTRACT

The Purchaser may not transfer his position in the contract or in individual binding agreements deriving from this without Florim Ceramiche S.p.A. SB's written acceptance: also in this case the Purchaser anyway remains jointly liable with the transferee for the obligations transferred.

12 INDUSTRIAL PROPERTY AND SELECTIVE DISTRIBUTION - LIMITS ON RESALE

Florim Ceramiche S.p.A. SB is the owner and legal holder of the exclusive rights to brand names, designs and patents. In order to guarantee full respect for Florim Ceramiche S.p.A. SB's exclusive rights, as well as the end consumers' expectations with regard to expected quality characteristics, Florim Ceramiche S.p.A. SB manages the supplies of its products by means of a selective distribution system. Supplies received from Florim Ceramiche S.p.A. SB and from its authorized selective sales outlets are designed for installation at the end user's premises and no other form of resale to further sales agents other than the end users is permitted, unless with Florim Ceramiche S.p.A. SB's prior written authorization. Goods that are re-sold in breach of this provision must therefore be considered as not permitted and treated as an unlawful use of Florim Ceramiche S.p.A. SB's industrial and intellectual property rights, with Florim Ceramiche S.p.A. SB's right to ask for them to be seized at the premises of any holder. Florim Ceramiche S.p.A. SB reserves the right to take legal proceedings against anyone who is involved in unauthorized re-selling.

13 LAW GOVERNING THE CONTRACT - PLACE OF JURISDICTION

The contract is governed by Italian law, including the customs of the sector in Modena Province. For any dispute that may in any case derive from the supply contract, either on the part of Florim Ceramiche S.p.A. SB or on the part of the Purchaser, the Modena Court has exclusive competence. Florim Ceramiche S.p.A. SB nevertheless has the right to resort to different or competing judicial authorities.

14. SUPPLY CHAIN SECURITY

Florim Ceramiche S.p.A. SB, in order to grant the security of the international supply chain, kindly asks its CUSTOMERS to comply with the security requirements laid down by AEO - Authorised Economic Operator - CUSTOMS - to safeguard the goods in the European Community during the activities of the forward and reverse flows. Florim Ceramiche S.p.A. SB CUSTOMERS undertake to meet the security and safety conditions during the operations of receiving, delivery, distribution, transport and storage, ensuring that the goods are taken into delivery, stocked, transported, prepared and loaded in safe places and in safe loading and shipping areas, well protected against intrusion and manipulation, with the only employ of reliable, authorized and duly trained own personnel

All items on this price list are exclusively sold in complete boxes.

THIS PRICE LIST CANCELS AND REPLACES ANY PREVIOUS ONES

CONDITIONS GÉNÉRALES DE VENTE

1 NORME CONTRACTUELLE

Sauf modifications ou dérogations convenues par écrit, les présentes conditions générales s'appliquent à tous les contrats de vente entre Florim et l'Acquéreur sans qu'il soit nécessaire d'y faire une référence expresse. Les variations des conditions générales de vente, les offres, crédits ou réductions accordés par nos agents ou d'autres intermédiaires ne sont valables que s'ils ont été acceptés par écrit par notre siège.

2 OBJET DE LA FOURNITURE

La fourniture correspond uniquement aux matériaux, prestations et quantités spécifiés dans notre confirmation de commande. Le texte de la confirmation de commande de Florim prévaut dans tous les cas par rapport au texte non conforme de la commande ou de l'offre éventuelle.

3 CONFIRMATION DE COMMANDE

En cas de divergences des éléments de la confirmation de commande de Florim par rapport aux accords ou aux commandes, l'Acquéreur pourra formuler une réclamation écrite dans les 7 jours suivant la réception de notre confirmation. Passé ce délai, la commande sera considérée comme ayant été acceptée telle qu'elle a été rédigée. Le client s'engage à communiquer à Florim Ceramiche S.p.A. SB, l'éventuelle variation du lieu de destination de la marchandise, si différente de celle prévue dans la confirmation de la commande, au plus tard le jour prévu du retrait chez Florim Ceramiche S.p.A. SB, par l'envoi, par poste, ou e-mail, des données d'identification du destinataire des marchandises et du lieu où la livraison devra être effectuée. En cas de manquement de communication la destination indiquée à l'origine sera tacitement confirmée.

4 PRIX

Les prix indiqués sur les catalogues Florim Ceramiche S.p.A. SB ne sont pas contraignants; nous nous réservons par conséquent le droit de les modifier préalablement à l'acceptation de la commande. Les prix conenus pour chaque vente s'entendent hors taxes, payés au comptant pour une livraison franco usine, sauf accord contraire stipulé par écrit. Si des hausses du coût des matières premières, de la main-d'œuvre, des combustibles, des frais de production et de transport, etc. et en cas d'une importante variation des taux de change entre la devise de facturation et la devise inter apparaissent entre la date de commande (même après la confirmation de commande) et la date de livraison, Florim Ceramiche S.p.A. SB pourra augmenter le prix convenu en informant l'Acquéreur par écrit, y compris par courrier électronique. Cependant, si ledit prix dépasse de 20% celui convenu lors de la commande, l'Acquéreur pourra résilier le contrat en nous faisant part de sa volonté par lettre recommandée dans un délai préemptoire de 10 jours à compter de la réception de l'avis d'augmentation du prix. Dans le cas contraire, le nouveau prix sera considéré comme ayant été accepté.

5 LIVRAISONS

La vente, sauf accord différent indiqué par écrit, s'entend toujours franco usine Florim Ceramiche S.p.A. SB. La marchandise voyage aux risques et périls de l'Acquéreur. Toutes nos responsabilités prennent fin avec la remise au transporteur, auquel l'Acquéreur, après les contrôles de rigueur, devra s'adresser pour d'éventuelles réclamations. Les expéditions de fournitures à l'étranger par voie terrestre ou maritime sont effectuées selon les conditions choisies d'une fois sur l'autre, conformément aux Incoterms approuvés par la Chambre de commerce internationale.

6 DÉLAIS DE LIVRAISON

En dehors de livraisons spéciales données à titre indicatif: les éventuels retards de livraison, les interruptions, les suspensions totales ou partielles de fourniture n'ouvriront pas droit à une indemnisation ou à des dommages-intérêts, sauf accord contraire stipulé par écrit.

7 ÉCHANTILLONS

Les informations reportées sur les documents d'illustration de Florim Ceramiche S.p.A. SB, de même que les caractéristiques des échantillons et modèles envoyés par Florim Ceramiche S.p.A. SB à l'Acquéreur, sont données à titre purement indicatif. Ces données n'ont aucune valeur contraignante, à moins que cela ait été indiqué expressément dans l'offre ou dans l'acceptation écrite de Florim Ceramiche S.p.A. SB.

8 PAIEMENTS

Les factures de Florim Ceramiche S.p.A. SB, peuvent être émises le jour de la fourniture, à cadence bimensuelle ou mensuelle doivent être payées conformément à l'échéance prévue. Toute obligation de paiement entre les parties contractantes doit être exécutée auprès du siège de Florim Ceramiche S.p.A. SB. Les paiements éventuels faits à des agents, représentants ou auxiliaires de commerce de Florim Ceramiche S.p.A. SB ne seront considérés comme effectifs qu'à compter de la réception par Florim Ceramiche S.p.A. SB des sommes dues. Sauf accord contraire stipulé par écrit, le paiement devra être effectué au moment de la livraison auprès de l'institut bancaire indiqué par Florim Ceramiche S.p.A. SB. Tout retard ou toute irrégularité de paiement donnera à Florim Ceramiche S.p.A. SB le droit de suspendre les fournitures ou de résilier les contrats en cours, y compris ceux qui ne sont pas en lien avec les paiements en question, et de demander le remboursement des dommages éventuellement subis. Florim Ceramiche S.p.A. SB peut quoi qu'il en soit prétendre – à compter de l'arrivée à échéance du paiement, et sans nécessité de mise en demeure – à des intérêts moratoires conformément à la loi n° 231 du 09/10/2002. En cas de manquement même partiel, les intérêts moratoires sur le montant restant dû courent à compter du jour de la livraison, même si le délai de paiement convenu est fixé à une date ultérieure. Les réclamations relatives à des marchandises autres que celles de premier choix (B, commercial, 2e et 3e choix, correspondant, stock, etc.) ne seront pas prises en considération. Il ne sera donné aucun titre de garantie sur ces matériaux, ni implicitement ni explicitement. Obligation est faite à l'Acquéreur de contrôler la qualité et la quantité de la marchandise rapidement après la livraison et, en cas de réclamation, d'en donner communication par écrit dans les 8 (huit) jours suivant la réception sous peine de déchéance de ses droits. Les matériaux considérés comme défectueux devront être laissés à la disposition de Florim Ceramiche S.p.A. SB pour les contrôles jugés opportuns; toute action ultérieure (restitution, réparation ou autre) devra avoir été préalablement autorisée par écrit par nos soins. Les réclamations et demandes d'intervention en garantie postérieures à la pose ne seront pas prises en considération si le défaut constaté est manifeste (ex. pièces bréchées, défauts dimensionnels, différences de teinte, etc.). Il est précisé que le premier choix peut présenter des carreaux défectueux dans une limite de 5% et que la teinte du matériau fourni peut différer de l'échantillon exposé, l'aspect de la céramique étant intrinsèquement variable. Les réclamations pour des défauts ou des vices cachés devront être adressées par écrit dans les 8 (huit) jours suivant leur découverte, et dans tous les cas dans l'année suivant la livraison, sous peine d'une déchéance de tout droit à la garantie et au remboursement. La réclamation devra mentionner, outre les références de facturation, une description précise du vice et un devis des coûts de réparation ou de modification du produit; en l'absence de ces informations, la réclamation sera considérée comme nulle et non avenue. Si la réclamation se révèle infondée, l'Acquéreur devra rembourser à Florim Ceramiche S.p.A. SB tous les dépens engagés dans le cadre des contrôles (déplacements, expertises, etc.) effectués. Les obligations de Florim Ceramiche S.p.A. SB se limitent qu'il en soit au remplacement des pièces défectueuses ou à leur réparation, à l'exclusion expresse de toute indemnisation ultérieure comme, à titre indicatif mais sans limitation aucune, pour des coûts de déplacement et de remise en place de mobilier, de matériel, de machines, etc., de manques à gagner du fait d'une interruption ou d'une suspension d'activité, de perturbations, de dommages indirects, etc. La présence de carreaux défectueux n'invalide pas la qualité de l'ensemble de la fourniture et n'entraîne aucune obligation de remplacement intégral. Les limites temporelles de la durée de garantie sont celles définies par le code civil italien.

9 GARANTIES ET RÉCLAMATIONS

La qualité des matériaux céramiques est définie sur la base des normes internationales en vigueur qui s'appliquent à la classe de produit correspondant. La garantie de Florim Ceramiche S.p.A. SB ne porte que sur la marchandise de premier choix fournie. Les réclamations relatives à des marchandises autres que celles de premier choix (B, commercial, 2e et 3e choix, correspondant, stock, etc.) ne seront pas prises en considération. Il ne sera donné aucun titre de garantie sur ces matériaux, ni implicitement ni explicitement. Obligation est faite à l'Acquéreur de contrôler la qualité et la quantité de la marchandise rapidement après la livraison et, en cas de réclamation, d'en donner communication par écrit dans les 8 (huit) jours suivant la réception sous peine de déchéance de ses droits. Les matériaux considérés comme défectueux devront être laissés à la disposition de Florim Ceramiche S.p.A. SB pour les contrôles jugés opportuns; toute action ultérieure (restitution, réparation ou autre) devra avoir été préalablement autorisée par écrit par nos soins. Les réclamations et demandes d'intervention en garantie postérieures à la pose ne seront pas prises en considération si le défaut constaté est manifeste (ex. pièces bréchées, défauts dimensionnels, différences de teinte, etc.). Il est précisé que le premier choix peut présenter des carreaux défectueux dans une limite de 5% et que la teinte du matériau fourni peut différer de l'échantillon exposé, l'aspect de la céramique étant intrinsèquement variable. Les réclamations pour des défauts ou des vices cachés devront être adressées par écrit dans les 8 (huit) jours suivant leur découverte, et dans tous les cas dans l'année suivant la livraison, sous peine d'une déchéance de tout droit à la garantie et au remboursement. La réclamation devra mentionner, outre les références de facturation, une description précise du vice et un devis des coûts de réparation ou de modification du produit; en l'absence de ces informations, la réclamation sera considérée comme nulle et non avenue. Si la réclamation se révèle infondée, l'Acquéreur devra rembourser à Florim Ceramiche S.p.A. SB tous les dépens engagés dans le cadre des contrôles (déplacements, expertises, etc.) effectués. Les obligations de Florim Ceramiche S.p.A. SB se limitent qu'il en soit au remplacement des pièces défectueuses ou à leur réparation, à l'exclusion expresse de toute indemnisation ultérieure comme, à titre indicatif mais sans limitation aucune, pour des coûts de déplacement et de remise en place de mobilier, de matériel, de machines, etc., de manques à gagner du fait d'une interruption ou d'une suspension d'activité, de perturbations, de dommages indirects, etc. La présence de carreaux défectueux n'invalide pas la qualité de l'ensemble de la fourniture et n'entraîne aucune obligation de remplacement intégral. Les limites temporelles de la durée de garantie sont celles définies par le code civil italien.

10 RÉSERVE DE PROPRIÉTÉ

La vente de la marchandise s'effectue avec la clause de réserve de propriété. Par conséquent, si le paiement, du fait d'accords contractuels, est effectué en tout ou partie après la livraison, les produits livrés resteront la propriété de Florim Ceramiche S.p.A. SB jusqu'au paiement intégral du prix.

11 CESSIION DU CONTRAT

L'Acquéreur ne peut pas céder ses droits et obligations ni chacune des relations obligatoires nés du présent contrat sans l'accord écrit de Florim Ceramiche S.p.A. SB; même dans ce cas, l'Acquéreur restera solidaire du cessionnaire vis-à-vis des obligations cédées.

12 PROPRIÉTÉ INDUSTRIELLE ET DISTRIBUTION SÉLECTIVE - LIMITES À LA REVENTE

Florim Ceramiche S.p.A. SB est le titulaire et propriétaire légitime des exclusivités relatives aux marques, dessins et brevets d'invention. Pour garantir au mieux le respect des droits exclusifs de Florim Ceramiche S.p.A. SB et les empêcher d'être consommés de manière abusive, Florim Ceramiche S.p.A. SB a géré la fourniture des produits par l'intermédiaire d'un système de distribution sélective. Les fournitures acquises auprès de Florim Ceramiche S.p.A. SB et de ses points de vente sélectifs agréés sont destinées à une installation auprès de l'utilisateur final; aucune autre forme de revente à des intermédiaires commerciaux autres que les utilisateurs finals n'est autorisée, sauf autorisation préalable de Florim Ceramiche S.p.A. SB stipulée par écrit. Toute revente de marchandise en violation de ce principe doit donc être considérée comme interdite et assimilée à un usage illicite des droits de propriété industrielle et intellectuelle de Florim Ceramiche S.p.A. SB, donnant droit à Florim Ceramiche S.p.A. SB de demander la saisie de ladite marchandise auprès de son détenteur. Florim Ceramiche S.p.A. SB se réserve le droit de poursuivre en justice quiconque serait impliqué dans des reventes non autorisées.

13 LOI APPLICABLE ET JURIDICTION COMPÉTENTE

Le contrat est régi par la loi italienne, y compris les Usages de branche de la Province de Modène. Le tribunal de Modène est exclusivement compétent pour tout litige relatif au contrat de fourniture entre Florim Ceramiche S.p.A. SB et l'Acquéreur. Florim Ceramiche S.p.A. SB garde néanmoins la faculté de saisir des juridictions concurrentes ou alternatifs.

14 SÛRETÉ DANS LA CHAÎNE LOGISTIQUE

FLORIM CERAMICHE S.P.A. SB, afin d'assurer la sûreté de la logistique internationale, demande à ses CLIENTS le respect des standards des rapports contractuels pour assurer la sûreté des biens et leur conformité aux normes de la OEA (Operateur Economique Agréé – Douanes) dans tous les pays de l'Union Européenne. Les CLIENTS de Florim Ceramiche S.p.A. SB s'engagent à veiller à ce que la marchandise prise en charge ou livrée soit expédiée ou transportée, stockée, préparée et chargée dans des dépôts sûres et sur des endroits de chargement et d'expédition sûres, bien protégée contre possibles manipulations pas autorisées, et n'utilisant que du personnel autorisée et possiblement bien qualifié.

L'ensemble des articles de ce catalogue sont vendus exclusivement par paquets entiers.

LE PRÉSENT CATALOGUE ANNULE ET REMPLACE LES PRÉCÉDENTS

ALLGEMEINE GESCHÄFTSBEDINGUNGEN

1 VERTRAGSVORSCHRIFTEN

Diese Allgemeinen Geschäftsbedingungen gelten, vorbehaltlich schriftlich vereinbarter Änderungen oder Abweichungen, für alle Verkaufverträge zwischen Florim Ceramiche S.p.A. SB und dem Käufer ohne ausdrückliche Bezugnahme auf sie. Die Änderungen der allgemeinen Geschäftsbedingungen, die Angebote, die von unseren Handelsagenten oder anderen Vermittlern gewährten Gutschriften oder Nachlässe haben nur Gültigkeit, sofern sie von unserem Sitz schriftlich angenommen wurden.

2 GEGENSTAND DER LIEFERUNG

Die Lieferung umfasst nur die Materialien, Leistungen und Mengen, die in unserer Auftragsbestätigung angegeben sind. Der Text der Auftragsbestätigung von Florim Ceramiche S.p.A. SB hat auf jeden Fall Vorrang gegenüber dem Text, der von dem eventuellen Angebot oder der Bestellung abweichen sollte.

3 AUFTRAGSBESTÄTIGUNG

Falls in der Auftragsbestätigung von Florim Ceramiche S.p.A. SB Unterschiede der darin aufgelisteten einzelnen Elemente gegenüber den Vereinbarungen oder Bestellungen bestehen, gilt die Bestätigung in ihrer abgefassten Form als verbindlich, sofern der Käufer sie nicht binnen 7 Tagen nach Erhalt unserer Bestätigung schriftlich beanstandet hat.

4 PREISE

Die auf den Florim Ceramiche S.p.A. SB -Preislisten angeführten Preise sind unverbindlich; Demzufolge behalten wir uns das Recht vor, sie vor der Auftragsannahme abzuändern. Sofern keine anderen schriftlichen Vereinbarungen vorliegen, verstehen sich die für jeden Einzelverkauf vereinbarten Preise netto, gegen bar, Lieferung ab Werk. Sollten zwischen dem Bestelldatum (auch nach der Auftragsbestätigung) und dem Lieferdatum ein Kostenanstieg der Rohstoffe, Löhne, Brennstoffe, Herstellung, des Transports usw. auftreten, oder im Falle einer wesentlichen Änderung der Wechselkurse zwischen der Rechnungswährung und der lokalen Währung, kann Florim Ceramiche S.p.A. SB den vereinbarten Preis erhöhen, indem er dies dem Käufer schriftlich, auch mittels E-Mail, mitteilt. Sollte besagter Preis jedoch den bei der Bestellung vereinbarten Preis um 20% übersteigen, hat der Käufer die Möglichkeit, vom Vertrag zurückzutreten, indem er uns binnen der bindenden Frist von 10 Tagen nach Erhalt der Mitteilung bez. des Preisanstiegs seinen Willen per Einschreiben meldet. In Ermangelung dessen gilt der neue Preis als angenommen.

5 LIEFERUNGEN

Der Verkauf, sofern nicht schriftlich anders vereinbart, ist immer ab Florim Ceramiche S.p.A. SB-Werk. Der Warentransport erfolgt auf Risiko und Gefahr des Käufers. Unsere Haftung endet mit der Übergabe an den Frachtführer, an den der Käufer nach angemessener Überprüfung eventuelle Beanstandungen zu richten hat. Auslandslieferungen auf dem See- oder Landweg werden auf der Grundlage von Fall zu Fall gewählten Bedingungen vorgenommen, die in den von der Internationalen Handelskammer gebilligten "Incoterms" aufgeführt sind.

6 LIEFERBEDINGUNGEN

Die Lieferbedingungen sind hinweisend: Eventuelle Lieferverzögerungen, Unterbrechungen, komplette oder partielle Einstellungen der Lieferungen berechtigen weder zu einer Entschädigung noch zu einem Schadensersatz, sofern keine anderen schriftlichen Vereinbarungen vorliegen.

7 MUSTER

Die auf den veranschaulichenden Dokumenten von Florim Ceramiche S.p.A. SB abgebildeten Angaben sowie die Eigenschaften der vom Letztgenannten dem Käufer zugesandten Muster und Modelle sind als ungefähre Angaben zu verstehen und behält sich nicht um verbindliche Angaben, sofern sie nicht ausdrücklich als derartig im Angebot oder in der schriftlichen Annahme von Florim Ceramiche S.p.A. SB erwähnt wurden.

8 ZAHLUNGEN

Die Rechnungen von Florim Ceramiche S.p.A. SB können am Tag der Lieferung ausgestellt werden, 14-tägig oder monatlich und sind netto innerhalb der vereinbarten Frist zu bezahlen. Jegliche Zahlungsverpflichtung zwischen den Vertragspartnern ist am Florim Ceramiche S.p.A. SB -Sitz zu erfüllen, eventuell an Handelsagenten, Vertreter oder Geschäftshelfer von Florim Ceramiche S.p.A. SB geleistete Zahlungen verstehen sich so lange als nicht vorgenommen, bis die bezüglichen Summen bei Florim Ceramiche S.p.A. SB eingehen. Die Bezahlung hat, vorbehaltlich anderer schriftlicher Vereinbarungen, unmittelbar nach der Lieferung beim Bankinstitut zu erfolgen, das von Florim Ceramiche S.p.A. SB angegeben wurde. Jegliche Zahlungsverzögerungen und -unregelmäßigkeiten geben Florim Ceramiche S.p.A. SB das Recht, die Lieferungen einzustellen oder die laufenden Verträge aufzulösen, auch wenn sie sich nicht auf die zutreffenden Zahlungen beziehen, sowie das Recht auf den Ersatz etwaiger Schäden. Florim Ceramiche S.p.A. SB hat auf jeden Fall Anspruch auf die Verzugszinsen – ab der Verzugsfrist und ohne die Notwendigkeit einer Inverzugsetzung – in der laut Gesetzesverordnung Nr. 231 vom 09.10.2002 vorgesehenen Höhe. Im Falle einer auch nur teilweisen Nichterfüllung laufen die Verzugszinsen für den nicht bezahlten Betrag ab dem Tag der Lieferung, auch wenn als Zahlungsfrist ein späteres Datum vereinbart wurde. Keine Beanstandung oder Streitigkeit bezüglich der Warenqualität, Mängel oder Defekte, oder jedes anderen Vertragsaspekts ist wirksam und kann in Betracht gezogen werden, und gleichermaßen kann keine Klage eingeleitet werden, sofern keine vollständige Bezahlung des Preises erfolgte (Klausel solve et repete). Die Verrechnung mit eventuell entstandenen Forderungen gegen Florim Ceramiche S.p.A. SB ist unzulässig.

9 GARANTIE UND BEANSTANDUNGEN

Die Qualität des Keramikmaterials wird auf der Grundlage der geltenden internationalen Rechtsvorschriften festgelegt, die auf die jeweilige Produktklasse Anwendung finden. Florim Ceramiche S.p.A. SB garantiert nur die als erste Wahl gelieferte Ware. Beanstandung über die nicht zur ersten Klasse gehörenden Waren (B-Wahl, kommerzielle, zweite, dritte, zweitrangige Wahl, Lagerbestand, usw.) bleiben unberücksichtigt, wobei auf diese Materialien keine Art von Garantie, weder implizit noch explizit, erteilt wird. Der Käufer ist verpflichtet, die Ware binnen kurzer Zeit ab Erhalt der Lieferung und Qualität zu prüfen und bei einer Beanstandung dies schriftlich binnen spätestens 8 (acht) Tagen ab Warenerhalt mitzuteilen, da andernfalls jeglicher Anspruch verwirkt. Die als fehlerhaft betrachtete Ware ist Florim Ceramiche S.p.A. SB für seine als angemessen betrachteten Überprüfungen verfügbar zu halten; jeder weitere Vorgang (Rückersatzung, Reparatur oder sonstiges) bedarf unserer vorherigen schriftlichen Genehmigung. Beanstandungen und Beantragungen von Garantieeingriffen nach erfolgter Verlegung werden nicht in Betracht gezogen, sofern sich der beanstandete Defekt als offensichtlich erweisen sollte (zum Beispiel Schlagstellen, Maßunterschiede, Tonabweichungen, usw.). Es wird präzisiert, dass die erste Wahl bis zu 5% fehlerhafte Fliesen enthalten und die Färbung und die Farbgebung des gelieferten Materials vom ausgestellten Muster abweichen darf, da Keramik von Natur aus unterschiedlich aussehen kann. Auf verborgene Fehler oder Mängel bezogene Beanstandungen sind schriftlich binnen 8 (acht) Tagen ab ihrer Feststellung und auf jeden Fall binnen einem Jahr ab Lieferung zu formalisieren, da andernfalls die Verwirkung jeglichen Anspruchs auf Garantie und Entschädigung droht. Die Mitteilung muss neben den Rechnungsdaten eine genaue Beschreibung des Mangels und einen Kostenvoranschlag der Reparatur oder Änderung des Produkts enthalten; in Ermangelung dieser Angaben wird die Beanstandung als nichtig betrachtet. Sollte sich die Beanstandung als unbegründet erweisen, muss der Käufer Florim Ceramiche S.p.A. SB alle für die Überprüfung aufgetragenen Kosten (Reisen, Sachverständigen, usw.) vergüten. Die Pflicht von Florim Ceramiche S.p.A. SB beschränkt sich auf jeden Fall allein auf den Ersatz nur der fehlerhaften Teile oder auf die Reparatur, mit ausdrücklichem Ausschluss anderweitiger Entschädigungen wie beispielsweise - aber nicht ausschließlich - für Kosten zur Beseitigung und Wiederherrichtung von Möbeln, Ausrüstungen, Maschinen, usw., eingangene Gewinne wegen Tätigkeitsunterbrechung oder -einstellung, Unannehmlichkeiten, Folgeschäden, usw. Das Vorhandensein fehlerhafter Fliesen setzt weder die Güte der Gesamtlieferung herab noch ist damit die Pflicht des Gesamtsatzers verbunden. Die zeitlichen Beschränkungen der Garantiedauer sind laut dem italienischen Bürgerlichen Gesetzbuch festgelegt.

10 EIGENTUMSVORBEHALT

Der Warenverkauf erfolgt mit der Klausel des Eigentumsvorbehalts; deshalb bleiben die gelieferten Produkte, sofern deren Bezahlung laut Vertragsvereinbarungen gänzlich oder teilweise nach der Lieferung zu erfolgen hat, bis zur vollkommenen Bezahlung des Preises Eigentum von Florim Ceramiche S.p.A. SB.

11 VERTRAGSABTRETUNG

Der Käufer darf seine Stellung im Vertrag oder in einzelnen, aus diesem herrührenden obligatorischen Verhältnissen ohne schriftliche Einwilligung von Florim Ceramiche S.p.A. SB nicht abtreten; Auch in diesem Fall haftet der Käufer weiterhin mit dem Übernehmer solidarisch für die abgetretenen Verpflichtungen.

12 GERWERBLICHES EIGENTUM UND SELEKTIVER VERTRIEB BESCHRÄNKUNGEN BEIM WEITERVERKAUF

Florim Ceramiche S.p.A. SB ist Inhaber und rechtmäßiger Besitzer von Alleinrechten bezüglich Marken, Zeichnungen und Erfinderpapenten. Um die Beachtung der Alleinrechte von Florim Ceramiche S.p.A. SB und die Ansprüche der Endkunden im Hinblick auf die erwarteten Güteeigenschaften auf ein Höchstmaß gewährleisten zu können, liefert Florim Ceramiche S.p.A. SB seine Produkte im Rahmen eines selektiven Vertriebsystems. Die von Florim Ceramiche S.p.A. SB und seinen dazu befugten selektiven Verkaufsstellen gelieferten Produkte sind für die Verlegung beim Endbenutzer bestimmt. Eine andere Form des Weiterverkaufs an weitere Handelsvermittler, die nicht den Endbenutzern entsprechen, ist ohne vorherige schriftliche Einwilligung von Florim Ceramiche S.p.A. SB unzulässig. Die Ware, dessen Weiterverkauf trotz dieses Verbots erfolgte, ist somit als unzulässig zu betrachten und einem unerlaubten Gebrauch der gewerblichen und geistigen Eigentumsrechte von Florim Ceramiche S.p.A. SB gleichzusetzen, wobei Florim Ceramiche S.p.A. SB berechtigt ist, die Beschlagnahme bei jedem Besitzer zu beantragen. Florim Ceramiche S.p.A. SB behält sich das Recht vor, gegen all diejenigen gerichtlich vorzugehen, die an einem unbefugten Weiterverkauf beteiligt sind.

13 VERTRAGSGESETZ - ZUSTÄNDIGES GERICHT

Der Vertrag ist durch das italienische Gesetz, einschließlich der Branchengewohnheiten der Provinz Modena, geregelt. Für jegliche aus dem Liefervertrag herrührende Streitigkeit sowohl seitens Florim Ceramiche S.p.A. SB als auch des Käufers ist allein das Gericht Modena zuständig. Es ist jedoch in der Fakultät von Florim Ceramiche S.p.A. SB, konkurrierende oder alternative Foren anzurufen.

14 SICHERHEIT DES LOGISTISCHEN ABLAUFES

Um die Sicherheit des internationalen Logistikablaufs zu gewährleisten, verlangt Florim Ceramiche S.p.A. SB von seinen KUNDEN, dass sie sich an die Standardanforderungen halten, um die Sicherheit von Waren in vertraglichen Beziehungen zu gewährleisten und um die Einhaltung mit dem AEO - Authorized Economic Operator - Zollwesen, in der gesamten Europäischen Gemeinschaft sicherzustellen. Die Florim Ceramiche S.p.A. SB-KUNDEN verpflichten sich, zu gewährleisten, dass die übernommenen oder gelieferten Waren in sicherem Gelände und in sicheren Lade- und Versandbereichen versandt, transportiert, gelagert oder verladen, und vor unbefugter Manipulation geschützt werden, wobei nur autorisiertes und entsprechend ausgebildetes Personal eingesetzt werden darf.

Alle Artikel dieser Preisliste werden nur in ganzen Kartons verkauft.

DIE VORLIEGENDE PREISLISTE ANNULLIERT UND ERSETZT DIE VORHERIGEN PREISLISTEN.



CONDICIONES GENERALES DE VENTA

1 NORMATIVA CONTRACTUAL

Salvo modificaciones o derogaciones acordadas por escrito, las presentes condiciones generales disciplinan todos los contratos de venta entre Florim Ceramiche S.p.A. SB y el Comprador sin necesidad de una referencia expresa a ellos. Las variaciones de las condiciones generales de venta, ofertas, bonificaciones o descuentos, acordados por nuestros agentes o por otros intermediarios, solo son válidas previa aceptación escrita de nuestra empresa.

2 OBJETO DEL SUMINISTRO

El suministro comprende solamente los materiales, prestaciones y cantidades especificados en nuestra confirmación de pedido. El texto de la confirmación de pedido de Florim Ceramiche S.p.A. SB prevalecerá siempre sobre el texto de cualquier oferta o pedido.

3 CONFIRMACIÓN DE PEDIDO

Si la confirmación de pedido de Florim Ceramiche S.p.A. SB difiere de los acuerdos o pedidos en cuanto a los elementos que la componen, el Comprador podrá enviar la correspondiente reclamación por escrito en el plazo de 7 días a partir de la recepción de nuestra confirmación; en caso contrario, esta se considerará aceptada tal como ha sido redactada. Si el lugar de entrega de la mercancía es diferente del indicado en la confirmación de pedido, el cliente se compromete a comunicarlo a Florim Ceramiche S.p.A. SB antes del día previsto para el retiro o la sede de esta última. Dicha comunicación se debe realizar por correo, telefax o correo electrónico, y debe incluir los datos identificativos del destinatario de los bienes y del lugar en el que se debe realizar la entrega. En defecto de esta comunicación, el destino indicado originalmente se considera tácitamente confirmado.

4 PRECIOS

Los precios indicados en las listas Florim Ceramiche S.p.A. SB no son vinculantes; en consecuencia, nos reservamos el derecho a modificarlos antes de la aceptación del pedido. Los precios acordados para cada venta son netos, con pago en efectivo y entrega franco fábrica, salvo acuerdo escrito en contrario. Si entre la fecha del pedido (incluso después de la confirmación de pedido) y la fecha de entrega se verificaran aumentos en los costes de las materias primas, mano de obra, combustibles, gastos de producción, transporte, etc. y en caso de variaciones importantes en los tipos de cambio entre la divisa de facturación y la divisa interna, Florim Ceramiche S.p.A. SB podrá aumentar el precio acordado, comunicándolo por escrito al Comprador (también por telefax o correo electrónico). Si dicho precio supera en un 20 % el acordado en el momento del pedido, el Comprador podrá rescindir el contrato, comunicando su decisión por correo certificado en el plazo perentorio de 10 días a partir de la recepción de la notificación de aumento de precio. En su defecto, el nuevo precio se considerará aceptado.

5 ENTREGAS

La venta, salvo acuerdo escrito en sentido contrario, siempre es franco fábrica Florim Ceramiche S.p.A. SB. La mercancía viaja a cargo y riesgo del Comprador. Toda responsabilidad nuestra cesa en el momento de la entrega al transportista, ante el cual, una vez realizados los controles necesarios, el Comprador deberá plantear sus eventuales reclamaciones. Los envíos al exterior, por vía marítima o terrestre, se realizan según las condiciones establecidas en cada caso, indicadas en los "Incoterms" aprobados por la Cámara de Comercio Internacional.

6 PLAZOS DE ENTREGA

Los plazos de entrega tienen carácter indicativo; eventuales retrasos de las entregas, interrupciones y suspensiones totales o parciales de los suministros no darán derecho a indemnizaciones o resarcimientos de daños, salvo acuerdo escrito en contrario.

7 MUESTRAS

Los datos indicados en los documentos ilustrativos de Florim Ceramiche S.p.A. SB, así como las características de las muestras y modelos enviados por este último al Comprador, tienen carácter indicativo. Estos datos no tienen valor vinculante, excepto en la medida en que hayan sido expresamente mencionados como tales en la oferta o en la aceptación escrita de Florim Ceramiche S.p.A. SB.

8 PAGOS

Las facturas de Florim Ceramiche S.p.A. SB pueden ser emitidas el día de suministro, con cadencia quincenal o mensual y su importe neto debe ser pagado en el plazo acordado. Todas las obligaciones de pago entre las partes contratantes se deben cumplir en la sede de Florim Ceramiche S.p.A. SB. Eventuales pagos efectuados a agentes, representantes o auxiliares de comercio de Florim Ceramiche S.p.A. SB no se considerarán realizados hasta el momento en que las sumas correspondientes sean acreditadas a Florim Ceramiche S.p.A. SB. Salvo acuerdo escrito en contrario, el pago se deberá realizar en el momento de la entrega, en el banco indicado por Florim Ceramiche S.p.A. SB. Cualquier retraso o irregularidad en el pago da a Florim Ceramiche S.p.A. SB derecho a suspender los suministros o a resolver los contratos en curso, incluso si no corresponden a los pagos incumplidos, así como al resarcimiento de los eventuales daños. En todo caso, a partir del vencimiento del pago y sin necesidad de declaración de mora, Florim Ceramiche S.p.A. SB tiene derecho a percibir los intereses de mora en la medida prevista por el decreto legislativo N.º 231 del 09/10/2002. En caso de incumplimiento, incluso parcial, los intereses de mora sobre el importe no pagado se calculan a partir del día de la entrega, incluso si el plazo de pago había sido acordado en una fecha posterior. Ninguna reclamación o controversia inherente a la calidad de la mercancía, imperfecciones, defectos o cualquier otro aspecto del contrato será eficaz ni podrá ser tomada en consideración, y ninguna acción podrá ser iniciada, hasta el pago integral del precio (cláusula solve et repete). No se admiten compensaciones con eventuales créditos de cualquier naturaleza a favor Florim Ceramiche S.p.A. SB.

9 GARANTÍAS Y RECLAMACIONES

La calidad del material cerámico se define sobre la base de las normas internacionales aplicables a la clase de producto correspondiente. Florim Ceramiche S.p.A. SB garantiza solo la mercancía de primera calidad. Reclamaciones relativas a mercancía de otras calidades (calidad B, comercial, segunda, tercera, secundaria, existencias, etc.) no serán tomadas en consideración, ni se dará ningún tipo de garantía —implícita o explícita— sobre dicho material. El Comprador tiene la obligación de verificar la calidad y cantidad de la mercancía en breve plazo después de su recepción y, en caso de reclamación, comunicarla por escrito en el plazo de 8 (ocho) días a partir de la recepción, bajo pena de caducidad de cualquier derecho. El material considerado defectuoso deberá ser puesto a disposición de Florim Ceramiche S.p.A. SB para los controles que considere necesarios; cualquier otra acción (restitución, reparación, etc.) deberá ser autorizada previamente por Florim Ceramiche S.p.A. SB en forma escrita. Las reclamaciones y solicitudes de intervención en garantía después de la colocación no serán consideradas en el caso de que el defecto reclamado resulte manifiesto (por ejemplo: desportilladuras, defectos dimensionales, diferencias de tono, etc.). Se señala que la primera calidad puede contener hasta un 5 % de baldosas defectuosas y que el tono del material suministrado puede diferir de la muestra expuesta, dado que la cerámica es intrínsecamente variable en su aspecto. Las reclamaciones por defectos o imperfecciones ocultos deberán ser formalizados por escrito en el plazo de 9 (nueve) días a partir de su descubrimiento y, en todo caso, en el plazo de un año a partir de la entrega, bajo pena de caducidad de cualquier derecho a garantía y resarcimiento. Además de los datos de facturación, la comunicación deberá contener una precisa descripción del defecto y un presupuesto de los costes de reparación o modificación del producto; en ausencia de estos datos, la reclamación se considerará nula. Si la reclamación resulta infundada, el Comprador deberá resarcir a Florim Ceramiche S.p.A. SB todos los gastos realizados para la verificación (viajes, peritajes, etc.). En todo caso, la obligación de Florim Ceramiche S.p.A. SB se limita a la sustitución de las piezas defectuosas o a la reparación, quedando expresamente excluidas otras indemnizaciones, como - a título indicativo, no limitativo - costes de desplazamiento y recolocación de mobiliario, equipo, maquinaria, etc., lucro cesante debido a la interrupción o suspensión de actividades, molestias, daños indirectos, etc. La presencia de baldosas defectuosas no afecta la calidad del suministro en su conjunto, ni comporta la obligación de su sustitución integral. La duración de la garantía es la establecida por el código civil italiano.

10 RESERVA DE DOMINIO

La venta de la mercancía se realiza con cláusula de reserva de dominio; por lo tanto, si los acuerdos contractuales prevén que el pago del precio se realice - total o parcialmente - después de la entrega, los productos entregados seguirán siendo propiedad de Florim Ceramiche S.p.A. SB hasta el pago integral del precio.

11 CESIÓN DEL CONTRATO

El Comprador no puede ceder su posición en el contrato ni en relaciones obligatorias eventualmente derivadas del mismo, sin la aceptación escrita de Florim Ceramiche S.p.A. SB. En tal caso, el Comprador seguirá siendo responsable solidariamente con el cesionario de las obligaciones cedidas.

12 PROPIEDAD INDUSTRIAL Y DISTRIBUCIÓN SELECTIVA - LÍMITES DE REVENTA

Florim Ceramiche S.p.A. SB es titular y legítimo poseedor de la exclusividad de las marcas, dibujos y patentes de invención. Con el objetivo de garantizar adecuadamente el respeto de los derechos exclusivos de Florim Ceramiche S.p.A. SB, así como las expectativas de los consumidores finales en cuanto a las características cualitativas previstas, Florim Ceramiche S.p.A. SB controla la distribución de sus productos mediante un sistema de distribución selectiva. Los suministros enviados por Florim Ceramiche S.p.A. SB y por los puntos de venta autorizados están destinados a la satisfacción por parte del usuario final de una necesidad específica o a otros intermediarios comerciales diferentes de los usuarios finales, salvo previa autorización escrita de Florim Ceramiche S.p.A. SB. Por lo tanto, la reventa de mercancía que viole esta prohibición se debe considerar no permitida y equiparada a un uso ilícito de los derechos de propiedad industrial e intelectual de Florim Ceramiche S.p.A. SB, con derecho de esta última a solicitar la incautación de la mercancía a cualquier poseedor. Florim Ceramiche S.p.A. SB se reserva el derecho a proceder judicialmente contra todo aquel que esté involucrado en reventas no autorizadas.

13 LEY DEL CONTRATO - TRIBUNAL COMPETENTE

El contrato está disciplinado por la ley italiana, incluidos los Usos del Sector de la Provincia de Módena. Para cualquier controversia derivada del contrato de suministro, tanto por parte de Florim Ceramiche S.p.A. SB como por parte del Comprador, tiene competencia exclusiva el Tribunal de Módena. No obstante, es facultad de Florim Ceramiche S.p.A. SB recurrir a foro competidores o diferentes.

14 SEGURIDAD DE LA CADENA LOGÍSTICA

Florim Ceramiche S.p.A. SB, con la finalidad de garantizar la seguridad de la cadena logística internacional, les ruega a sus propios CLIENTES el respeto de unos requisitos estándar para garantizar la seguridad de las mercancías objeto de relaciones contractuales y para garantizar su conformidad con la normativa AEO - Operador Económico Autorizado - Aduanas, en toda la Comunidad Europea. Los CLIENTES de Florim Ceramiche S.p.A. SB se comprometen a garantizar que las mercancías recogidas en consignas o consignadas sean expedidas o transportadas, almacenadas, preparadas o cargadas en locales seguros y en zonas de carga y expedición seguras, protegidas contra manumisiones no autorizadas, utilizando solo personal interno autorizado y oportunamente instruido.

Todos los artículos del presente listín se venden exclusivamente en cajas completas.

EL PRESENTE LISTÍN ANULA Y SUSTITUYE LOS LISTINES ANTERIORES.

ОБЩИЕ УСЛОВИЯ ПРОДАЖИ

1 Контрактные отношения

При отсутствии согласованных в письменном виде изменений или отклонений настоящие общие условия остаются в силе при продаже, заключении или изменении контракта. Florim Ceramiche S.p.A. SB с Покупателем без необходимости прямой ссылки на них. Изменения общих условий продажи, предложения, кредиты или скидки, выданные нашими агентами или другими посредниками, недействительны, если они не были приняты в письменной форме нашими центральным офисом.

2 ПРЕДМЕТ ПОСТАВКИ

Поставка включает в себя лишь только материалы, услуги и количества, которые указаны в нашем подтверждении заказа. Текст подтверждения заказа Florim Ceramiche S.p.A. SB будет в любом случае преобладающим по отношению к другому тексту предложения или заказа.

3 ПОДТВЕРЖДЕНИЕ ЗАКАЗА

Даже если некоторые отдельные позиции в подтверждении заказа Florim Ceramiche S.p.A. SB отличаются от договоренностей или заказов, а Покупатель не возражал в письменной форме в течение 7 дней с получения нашего подтверждения, то считается, что он принял наше подтверждение заказа в отравленной ему редакции. В срок не позднее дня, назначенного для вывоза товара со склада Florim Ceramiche S.p.A. SB, клиент обязуется уведомить компанию Florim Ceramiche S.p.A. SB Ceramiche S.p.A. о возможном изменении места назначения товара, если оно отличается от адреса, указанного в подтверждении заказа. Для этого клиент должен сообщить по почте, факсу или электронной почте наименование грузополучателя и адрес доставки груза. При отсутствии такого сообщения первоначально указанное место назначения считается подтвержденным по умолчанию.

4 ЦЕНЫ

Цены, указанные в прайс-листе Florim Ceramiche S.p.A. SB, не являются обывающими, поэтому, мы оставляем за собой право на их изменение перед принятием заказа. При отсутствии иных письменных договоренностей согласованные для каждой отдельной сделки цены подразумеваются как цена-нетто, за наличный расчет и на условиях поставки франко-завод. Если с момента заказа (даже после подтверждения заказа) до момента поставки произойдет изменение цен, клиент обязан уведомить нас в письменной форме. Цены, указанные в прайс-листе, являются окончательными и трансфертными за вычетом и т.д., и в случае значительного изменения обменных курсов между валютой выставления счета и внутренней валютой, Florim Ceramiche S.p.A. SB имеет право увеличить согласованную цену, отправив письменное уведомление Покупателю даже по факсу или электронной почте. Тем не менее, если новая цена превышает согласованную в заказе более, чем на 20%, то Покупатель имеет право на расторжение договора, сообщив нам о своем желании расторгнуть контракт в письменной форме в 10-дневный срок с момента получения уведомления о повышении цены. При отсутствии согласия о расторжении новая цена считается принятой.

5 ПОСТАВКА

Продажа, если иное не согласовано в письменной форме, осуществляется всегда на условиях франко поставки Florim Ceramiche S.p.A. SB. Товар перевозится на страх и риск Покупателя. Любая ответственность с нашей стороны прекращается в момент передачи товара грузоперевозчику, которому Покупатель должен предъявлять возможные претензии после выполнения надлежащей проверки. Зарубежные перевозки морским или сухопутным путем будут осуществляться на условиях, выбранных в каждом конкретном случае, предусмотренных правилами Инкотермс, утвержденными Международной торговой палатой.

6 СРОКИ ПОСТАВКИ

Сроки поставки являются ориентировочными: при отсутствии иных письменных договоренностей возможная задержка отгрузки, приостановка, полное или частичное прекращение поставок не дает право на компенсацию или возмещение убытков.

7 ОБРАЗЦЫ

Данные, приведенные в рекламных документах компании Florim Ceramiche S.p.A. SB, а также характеристики образцов, представленные компанией Покупателю, имеют ориентировочный характер. Эти данные не носят обязательного характера, если они не были специально указаны как обывающие в предложении или в письменном подтверждении компании Florim Ceramiche S.p.A. SB.

8 ОПЛАТА

Иноязычные Florim Ceramiche S.p.A. SB могут быть выпущены в день осуществления поставки, раз в две недели или ежемесячно, и их сумма-нетто будет вложена в оплату. Все платежи должны быть осуществлены в срок. Все и любые платежные обязательства между договаривающимися сторонами должны выполняться по адресу Florim Ceramiche S.p.A. SB. Возможная оплата агентам, представителям или торговым помощникам Florim Ceramiche S.p.A. SB не считается выполненной до тех пор, пока соответствующие суммы не будут получены компанией Florim Ceramiche S.p.A. SB. При отсутствии иных письменных договоренностей оплата должна осуществляться в момент поставки товара в указанном Florim Ceramiche S.p.A. SB банке. Любая задержка или отклонение от норм при оплате дает Florim Ceramiche S.p.A. SB право на приостановку поставок или расторжение выполняющихся контрактов, даже если они не относятся к данной оплате, кроме того, это дает также компании право на требование возмещения ущерба. В любом случае с момента истечения срока оплаты и без необходимости направления официального предупреждения Florim Ceramiche S.p.A. SB имеет право на проценты по задолженности, начисленные в такой мере, которая предусмотрена постановлением № 231 от 09/10/2002, и которое касается только частного невыполнения обязательств проценты по неполной сумме будут начисляться с момента поставки, даже если срок оплаты был назначен на более позднюю дату. Никакая рекламация или спор о качестве товара, недостатках или дефектах или о любом другом аспекте контракта не будет иметь силу и не будет рассматриваться, равно как не может быть возбуждено никакое дело, без предварительной полной оплаты цены (условие обязательной оплаты solve et retere). Не допускается компенсация с возможно причитающимися по какой-либо причине кредитами от Florim Ceramiche S.p.A. SB.

9 ГАРАНТИЯ И РЕКЛАМАЦИЯ

Качество керамического материала определяется на основе действующих международных правил, относящихся к соответствующему сорту продукции. Florim Ceramiche S.p.A. SB гарантирует лишь только поставленный товар первого сорта. Реализация товара, сорт которого отличается от первого (сорт "B", коммерческий, второй, третий, вторичный, складские запасы и т.д.), не рассматривается и не принимается, кроме того, на такие материалы не дается никакая подразумевающаяся или явно выраженная гарантия. Покупатель обязан проверить качество и количество товара сразу после его получения и при возникновении претензий заявить о них в письменном сообщении не позднее 8 (восьми) дней с момента получения товара, в противном случае любое право отменяется. Материал, который считается дефективным, необходимо оставить в распоряжении компании Florim Ceramiche S.p.A. SB для выполнения контроля, который она сочтет необходимым; любое другое действие (возврат, ремонт или иное) должно быть предварительно разрешено нашей компанией в письменном виде. Претензии или требования оказания гарантийного обслуживания после укладки товара к рассмотрению не принимаются, если заявленный дефект является очевидным (например, поврежденные изделия, наличие размеров отклонений, разницы тона и т.д.). Уточним, что товар первого сорта может содержать дефектную плитку вплоть до 5%, и что тон поставленного материала может отличаться от выставленного образца, так как керамическая продукция может обладать изменчивым внешним видом. Претензии, связанные со скрытыми дефектами или пороками, должны быть предъявлены в письменном сообщении в течение 8 (восьми) дней с их обнаружения, и в любом случае не позднее одного года с момента поставки, иначе теряется право на гарантию и возмещение. Помимо данных об иноязыче необходимо указать точное описание дефекта, включая перечень признаков, за удаление и новое размещение мебели, оборудования, станков и т.д., за упущенную прибыль в связи с приостановкой или прекращением деятельности, за неудобство, косвенные убытки и т.д. Присутствие дефектной плитки не ставит под сомнение качество всей поставки, а также не влечет за собой обязательство ее полной замены. Предельные сроки действия гарантии предусмотрены Итальянским гражданским кодексом.

10 ОГРАНИЧЕННОЕ ПРАВО СОБСТВЕННОСТИ

Товар продается на условиях ограниченного права собственности; поэтому, если на основе контрактных договоренностей оплата будет осуществлена полностью или частично после поставки, то товар остается в собственности компании Florim Ceramiche S.p.A. SB до полной оплаты цены.

11 УСТУПКА Контракта

Покупатель не имеет права уступить контракт или отдельные вытекающие из него обязанности без письменного на то разрешения компании Florim Ceramiche S.p.A. SB; даже в этом случае Покупатель несет солидарную ответственность с правопреемником за уступленные обязанности.

12 ПРОМЫШЛЕННАЯ СОБСТВЕННОСТЬ И СЕЛЕКТИВНАЯ ДИСТРИБУЦИЯ – ОГРАНИЧЕНИЯ НА ПЕРЕПРОДАЖУ

Florim Ceramiche S.p.A. SB является владельцем и законным держателем исключительных прав на торговые марки, дизайн и патенты на изобретение. Для наилучшей охраны эксклюзивных прав Florim Ceramiche S.p.A. SB, а также ожиданий конечных потребителей в качестве, Florim Ceramiche S.p.A. SB осуществляет поставку своей продукции при помощи системы селективной дистрибуции. Поставки, выполненные компанией Florim Ceramiche S.p.A. SB и ее селективно уполномоченными торговыми точками, предназначены для укладки и обслуживания конечными потребителями. Явно предельно ограниченного разрешения Florim Ceramiche S.p.A. SB запрещается любая другая форма перепродажи или распространения продукции, которая не является конечными потребителями. Продажа товара с нарушением данного условия должна считаться неразрешенной и приравниваться к незаконному использованию прав промышленной и интеллектуальной собственности Florim Ceramiche S.p.A. SB, что представляет компании Florim Ceramiche S.p.A. SB право потребовать наложения ареста на товар у какого-либо обладателя. Компания Florim Ceramiche S.p.A. SB оставляет за собой право подавать иск на всех, кто вовлечен в неразрешенную перепродажу ее продукции.

13 РЕГУЛИРУЮЩИЙ ЗАКОН - КОМПЕТЕНТНЫЙ СУД

Настоящий контракт регулируется итальянским законом, в том числе и отраслевыми обычаями, действующими в Италии. Местом разрешения споров, как в образном, так и в реальном, является контракт на поставку возбужденных как Florim Ceramiche S.p.A. SB, так и Покупателем, единственным компетентным судом является суд г. Модена. Тем не менее, Florim Ceramiche S.p.A. SB имеет право обращаться к другим судебным властям.

14 БЕЗОПАСНОСТЬ ЦЕПИ ПОСТАВОК

Для обеспечения безопасности международной цепи поставок Florim Ceramiche S.p.A. SB требует от своих КЛИЕНТОВ соблюдения стандартных требований в контрактных отношениях для обеспечения безопасности грузов и их соответствия таможенным правилам для УЭО, упомянутых экономических операторов, на всей территории Евросоюза. КЛИЕНТЫ Florim Ceramiche S.p.A. SB должны гарантировать, что полученные или передаваемые товары отгружаются или перевозятся, складируются, проходят подготовительные и погрузочно-разгрузочные операции безопасных помощников или безопасных погрузочных или складских площадках защищенных от несанкционированного вмешательства, с привлечением только уполномоченного, собственного персонала, прошедшего необходимую подготовку.

Все изделия, включенные в данный прайс-лист, продаются только целыми упаковками.

НАСТОЯЩИЙ ПРАЙС-ЛИСТ АННИУЛИРУЕТ И ЗАМЕНЯЕТ ВСЕ ПРЕДЫДУЩИЕ.

Quanto contenuto nel catalogo è indicativo e non esaustivo riguardo alle grafiche, decori e ai colori riportati.

Contents of this catalog is indicative and not exhaustive with regard to graphics, decors and colors shown.

Le contenu du catalogue est indicatif et non exhaustive en ce qui concerne graphiques, décors et couleurs indiquées.

Die Beschreibungen im Katalog sind indikativ und nicht allumfassend in Bezug auf Grafiken, Dekore und Farben.

El contenido de este catálogo es indicativo y no exhaustivo con respecto a gráficas, decoros y colores ilustrados.

Информация, содержащаяся в каталоге - ориентировочна а не исчерпывающая по поводу процитированных график, декоративных элементов и цветов.



Florim Ceramiche S.p.A. SB

Via Canaletto, 24 /41042 Fiorano Modenese (MO) / T. +39 0536 840111 / F. +39 0536 844750 / florim.com