



# ***Pan***

***Spotlight Series***





## FEATURES

### Mechanical

Body: Aluminium  
 Finish: Electrostatic powder painted  
 Installation: Ceiling recessed  
 Diffuser: Transparent safety glass  
 Optics: Aluminium reflector

### Electrical

Driver: LED driver inside the body  
 Light source: COB LED  
 Frequency: 220-240V 50/60 Hz  
 Lifetime: 50.000 hours  
 Pfc: 0.90  
 Operating Temperature: -20 / +50

### Options

RAL selection  
 CRI>90  
 Microprismatic diffuser /  
 UGR<19  
 DALI  
 0-10V / 1-10V  
 Casambi  
 Emergency kit /  
 CBS connection  
 GST connector

### Optical

Beam angle: 15-30-45-60 degrees  
 options  
 UGR: <21  
 CRI>80  
 McAdams Step<3

## Specifications

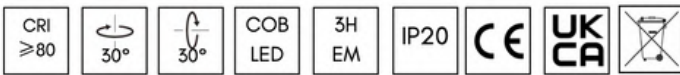

## Photometric Data

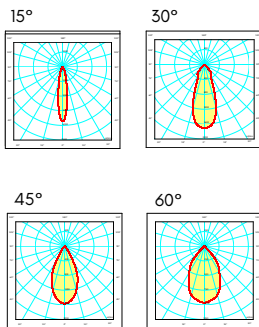

## CCT Values

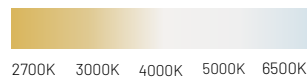

## Technical Drawing

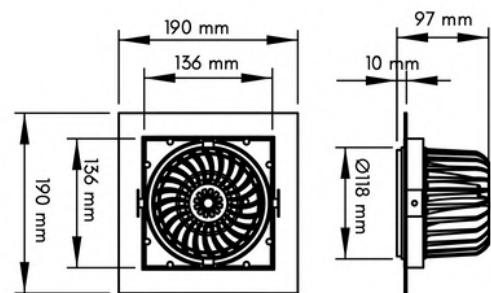

Art. No.	Watt	Lumen	CCT	Dimensions (WxLxH) mm.	Cut-out (mm.)	Weight (kg.)
ISS-401-030-827	30W	3000	2700K	190x190x97	170x170	1,4 kg.
ISS-401-030-830	30W	3150	3000K	190x190x97	170x170	1,4 kg.
ISS-401-030-840	30W	3300	4000K	190x190x97	170x170	1,4 kg.
ISS-401-030-865	30W	3420	6500K	190x190x97	170x170	1,4 kg.
ISS-401-035-827	35W	3530	2700K	190x190x97	170x170	1,4 kg.
ISS-401-035-830	35W	3700	3000K	190x190x97	170x170	1,4 kg.
ISS-401-035-840	35W	3900	4000K	190x190x97	170x170	1,4 kg.
ISS-401-035-865	35W	4090	6500K	190x190x97	170x170	1,4 kg.



# PAN II

SKU: ISS-402 Categories: [Interior](#), [Spotlights](#)



## FEATURES

### Mechanical

Body: Aluminium  
Finish: Electrostatic powder painted  
Installation: Ceiling recessed  
Diffuser: Transparent safety glass  
Optics: Aluminium reflector

### Electrical

Driver: LED driver inside the body  
Light source: COB LED  
Frequency: 220-240V 50/60 Hz  
Lifetime: 50.000 hours  
Pfc: >0.90  
Operating Temperature: -20 / +50

### Options

RAL selection  
CRI>90  
CRI>97  
DALI  
0-10V / 1-10V  
Casambi  
Emergency kit /  
CBS connection  
GST connector

### Optical

Beam angle: 15-30-45-60 degrees options  
UGR: <21  
CRI>80  
McAdams Step<3

## Specifications

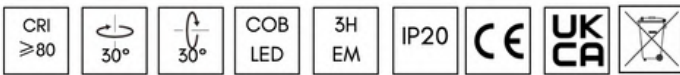

## Photometric Data

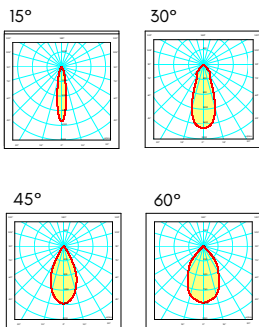

## CCT Values

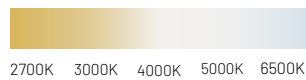

## Technical Drawing

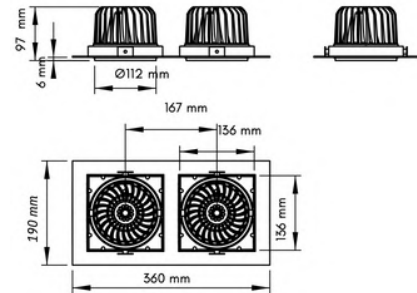

Art. No.	Watt	Lumen	CCT	Dimensions (WxLxH) mm.	Cut-out (mm.)	Weight (kg.)
ISS-402-060-827	2x30W	6000	2700K	190x360x97	170x330	2,7 kg.
ISS-402-060-830	2x30W	6300	3000K	190x360x97	170x330	2,7 kg.
ISS-402-060-840	2x30W	6600	4000K	190x360x97	170x330	2,7 kg.
ISS-402-060-865	2x30W	6840	6500K	190x360x97	170x330	2,7 kg.
ISS-402-070-827	2x35W	7060	2700K	190x360x97	170x330	2,7 kg.
ISS-402-070-830	2x35W	7400	3000K	190x360x97	170x330	2,7 kg.
ISS-402-070-840	2x35W	7800	4000K	190x360x97	170x330	2,7 kg.
ISS-402-070-865	2x35W	8180	6500K	190x360x97	170x330	2,7 kg.

# PAN III

SKU: ISS-403 Categories: [Interior](#), [Spotlights](#)



## FEATURES

### Mechanical

Body: Aluminium  
Finish: Electrostatic powder painted  
Installation: Ceiling recessed  
Diffuser: Transparent safety glass  
Optics: Aluminium reflector

### Electrical

Driver: LED driver inside the body  
Light source: COB LED  
Frequency: 220-240V 50/60 Hz  
Lifetime: 50.000 hours  
P<sub>f</sub>: 0.90  
Operating Temperature: -20 / +50

### Options

RAL selection  
CRI>90  
CRI>97  
DALI  
0-10V / 1-10V  
Casambi  
Emergency kit /  
CBS connection  
GST connector

### Optical

Beam angle: 15-30-45-60 degrees  
options  
UGR: <21  
CRI>80  
McAdams Step<3

## Specifications

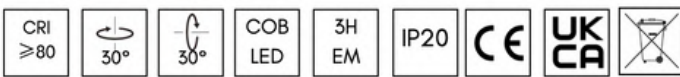

## Photometric Data

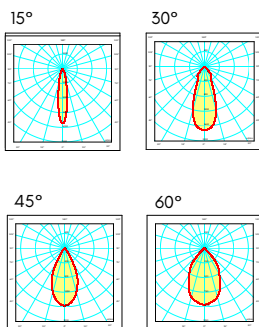

## CCT Values



## Technical Drawing

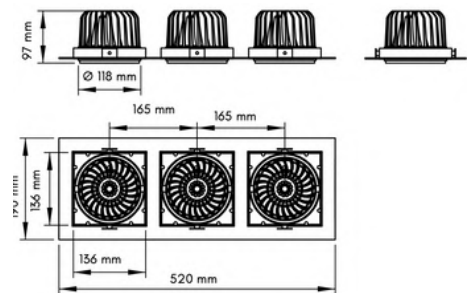

Art. No.	Watt	Lumen	CCT	Dimensions (WxLxH) mm.	Cut-out (mm.)	Weight (kg.)
ISS-403-090-827	3x30W	9000	2700K	190x520x97	170x490	4,0 kg.
ISS-403-090-830	3x30W	9450	3000K	190x520x97	170x490	4,0 kg.
ISS-403-090-840	3x30W	9900	4000K	190x520x97	170x490	4,0 kg.
ISS-403-090-865	3x30W	10260	6500K	190x520x97	170x490	4,0 kg.
ISS-403-115-827	3x35W	10590	2700K	190x520x97	170x490	4,0 kg.
ISS-403-115-830	3x35W	11100	3000K	190x520x97	170x490	4,0 kg.
ISS-403-115-840	3x35W	11700	4000K	190x520x97	170x490	4,0 kg.
ISS-403-115-865	3x35W	12270	6500K	190x520x97	170x490	4,0 kg.



# Teos

Spotlight Series





## FEATURES

### Mechanical

Body: Aluminium  
 Finish: Electrostatic powder painted  
 Installation: Ceiling recessed mounted  
 Diffuser: Transparent safety glass  
 Optics: Aluminum reflector

### Electrical

Driver: LED driver with external connection  
 Light source: COB LED  
 Frequency: 220-240V 50/60 Hz  
 Lifetime: 50.000 hours  
 P<sub>f</sub>>0,90  
 Operating Temperature: -20 / +50

### Options

RAL selection  
 CRI>90  
 CRI>97  
 DALI  
 0-10V / 1-10V  
 Casambi  
 Emergency kit /  
 CBS connection  
 GST connector

### Optical

Beam angle: 15-30-45 degrees  
 UGR: <21  
 CRI>80  
 McAdams Step<3

## Specifications

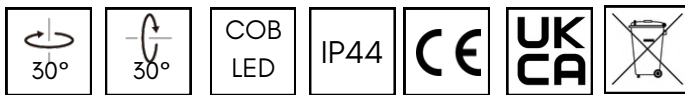

## Photometric Data

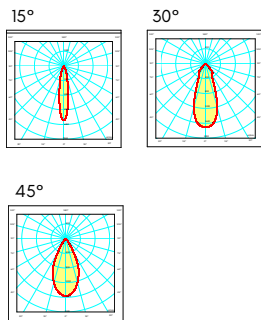

## CCT Values

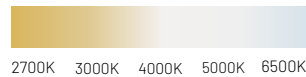

## Technical Drawing

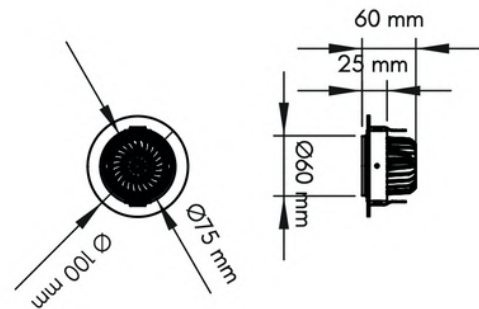

Art. No.	Watt	Lumen	CCT	Dimensions (QxH) mm.	Cut-out (mm.)	Weight (kg.)
ISS-444-008-827	8W	780	2700K	100x60	100	0,4 kg.
ISS-444-008-830	8W	820	3000K	100x60	100	0,4 kg.
ISS-444-008-840	8W	900	4000K	100x60	100	0,4 kg.
ISS-444-008-865	8W	945	6500K	100x60	100	0,4 kg.
ISS-444-010-827	10W	960	2700K	100x60	100	0,4 kg.
ISS-444-010-830	10W	1010	3000K	100x60	100	0,4 kg.
ISS-444-010-840	10W	1100	4000K	100x60	100	0,4 kg.
ISS-444-010-865	10W	1220	6500K	100x60	100	0,4 kg.

# TEOS II

SKU: ISS-420 Categories: [Interior](#), [Spotlights](#)



## FEATURES

### Mechanical

Body: Aluminium  
Finish: Electrostatic powder painted  
Installation: Ceiling recessed mounted  
Diffuser: Transparent safety glass  
Optics: Aluminum reflector

### Electrical

Driver: LED driver with external connection  
Light source: COB LED  
Frequency: 220-240V 50/60 Hz  
Lifetime: 50.000 hours  
P<sub>f</sub>>0,90  
Operating Temperature: -20 / +50

### Options

RAL selection  
CRI>90  
CRI>97  
DALI  
0-10V / 1-10V  
Casambi  
Emergency kit /  
CBS connection  
GST connector

### Optical

Beam angle: 15-30-45 degrees  
UGR: <21  
CRI>80  
McAdams Step<3

## Specifications

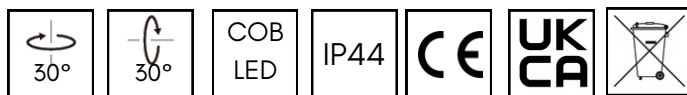

## Photometric Data

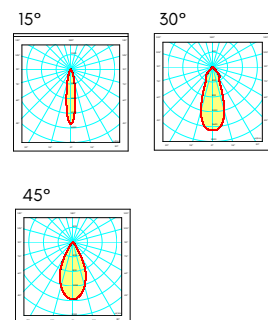

## CCT Values

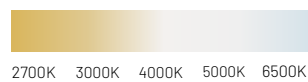

## Technical Drawing

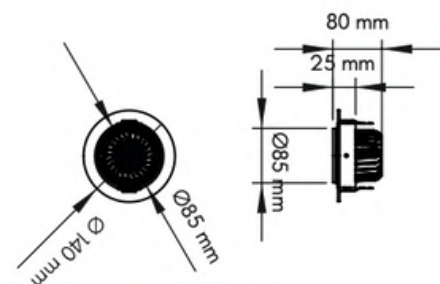

Art. No.	Watt	Lumen	CCT	Dimensions (QxH) mm.	Cut-out (mm.)	Weight (kg.)
ISS-445-015-827	15W	1520	2700K	140x80	120	0,4 kg.
ISS-445-015-830	15W	1590	3000K	140x80	120	0,4 kg.
ISS-445-015-840	15W	1680	4000K	140x80	120	0,4 kg.
ISS-445-015-865	15W	1775	6500K	140x80	120	0,4 kg.
ISS-445-020-827	20W	2000	2700K	140x80	120	0,4 kg.
ISS-445-020-830	20W	2120	3000K	140x80	120	0,4 kg.
ISS-445-020-840	20W	2200	4000K	140x80	120	0,4 kg.
ISS-445-020-865	20W	2260	6500K	140x80	120	0,4 kg.



# TEOS III

SKU: ISS-421 Categories: [Interior](#), [Spotlights](#)



## FEATURES

### Mechanical

Body: Aluminium  
Finish: Electrostatic powder painted  
Installation: Ceiling recessed mounted  
Diffuser: Transparent safety glass  
Optics: Aluminum reflector

### Electrical

Driver: LED driver with external connection  
Light source: COB LED  
Frequency: 220-240V 50/60 Hz  
Lifetime: 50.000 hours  
P<sub>f</sub>>0.90  
Operating Temperature: -20 / +50

### Options

RAL selection  
CRI>90  
CRI>97  
DALI  
0-10V / 1-10V  
Casambi  
Emergency kit /  
CBS connection  
GST connector

### Optical

Beam angle: 15-30-45-60 degrees  
UGR: <21  
CRI>80  
McAdams Step<3

## Specifications

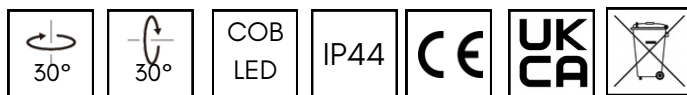

## Photometric Data

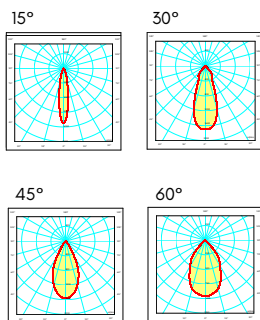

## CCT Values



## Technical Drawing

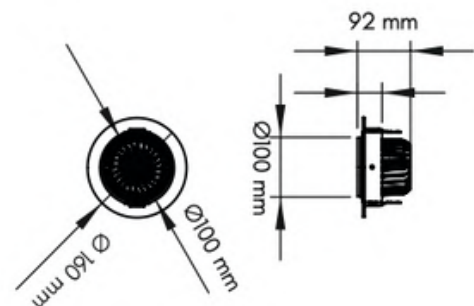

Art. No.	Watt	Lumen	CCT	Dimensions (QxH) mm.	Cut-out (mm.)	Weight (kg.)
ISS-446-020-827	20W	2000	2700K	160x92	145	0,9 kg.
ISS-446-020-830	20W	2120	3000K	160x92	145	0,9 kg.
ISS-446-020-840	20W	2200	4000K	160x92	145	0,9 kg.
ISS-446-020-865	20W	2260	6500K	160x92	145	0,9 kg.
ISS-446-030-827	30W	3010	2700K	160x92	145	0,9 kg.
ISS-446-030-830	30W	3150	3000K	160x92	145	0,9 kg.
ISS-446-030-840	30W	3300	4000K	160x92	145	0,9 kg.
ISS-446-030-865	30W	3430	6500K	160x92	145	0,9 kg.

# TEOS IV

SKU: ISS-422 Categories: [Interior](#), [Spotlights](#)



## FEATURES

### Mechanical

Body: Aluminium  
Finish: Electrostatic powder painted  
Installation: Ceiling recessed mounted  
Diffuser: Transparent safety glass  
Optics: Aluminum reflector

### Electrical

Driver: LED driver with external connection  
Light source: COB LED  
Frequency: 220-240V 50/60 Hz  
Lifetime: 50.000 hours  
P<sub>f</sub>>0.90  
Operating Temperature: -20 / +50

### Options

RAL selection  
CRI>90  
CRI>97  
DALI  
0-10V / 1-10V  
Casambi  
Emergency kit /  
CBS connection  
GST connector

### Optical

Beam angle: 15-30-45-60 degrees  
UGR: <21  
CRI>80  
McAdams Step<3

## Specifications

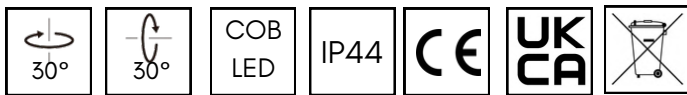

## Photometric Data

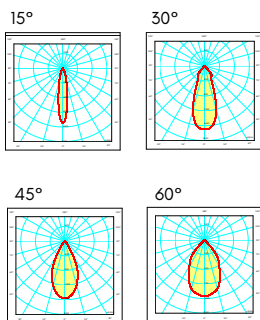

## CCT Values

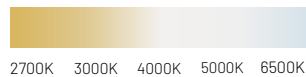

## Technical Drawing

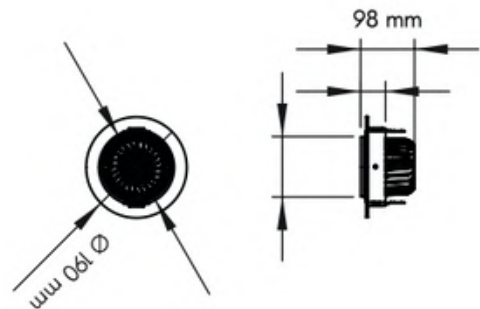

Art. No.	Watt	Lumen	CCT	Dimensions (QxH) mm.	Cut-out (mm.)	Weight (kg.)
ISS-447-030-827	30W	3010	2700K	160x92	145	0,9 kg.
ISS-447-030-830	30W	3150	3000K	160x92	145	0,9 kg.
ISS-447-030-840	30W	3300	4000K	160x92	145	0,9 kg.
ISS-447-030-865	30W	3430	6500K	160x92	145	0,9 kg.
ISS-447-035-827	35W	3530	2700K	160x92	145	0,9 kg.
ISS-447-035-830	35W	3700	3000K	160x92	145	0,9 kg.
ISS-447-035-840	35W	3900	4000K	160x92	145	0,9 kg.
ISS-4447-035-865	35W	4090	6500K	160x92	145	0,9 kg.







# Myra

## Spotlight Series



# MYRA I

SKU: ISS-416 Categories: [Interior](#), [Spotlights](#)



## FEATURES

### Mechanical

Body: Aluminium  
 Finish: Electrostatic powder painted  
 Installation: Ceiling srecessed mounted  
 Diffuser: Transparent safety glass  
 Optics: Aluminium reflector

### Electrical

Driver: LED driver with external connections  
 Light source: COB LED  
 Frequency: 220-240V 50/60 Hz  
 Lifetime: 50.000 hours  
 P<sub>f</sub>>0.90  
 Operating Temperature: -20 / +50

### Options

RAL selection  
 CRI>90  
 CRI>97  
 DALI  
 0-10V / 1-10V  
 Casambi  
 Emergency kit /  
 CBS connection  
 GST connector  
 Honeycomb louvre

### Optical

Beam angle: 15-30-45 degrees  
 UGR: <21  
 CRI>90  
 McAdams Step<3

## Specifications

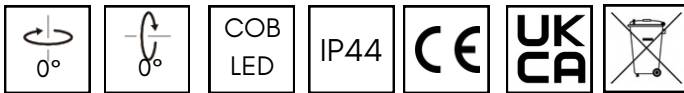

## Photometric Data

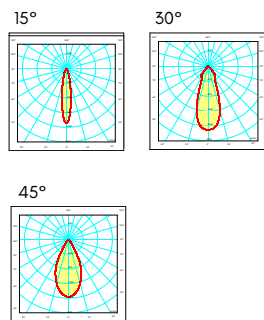

## CCT Values



## Technical Drawing

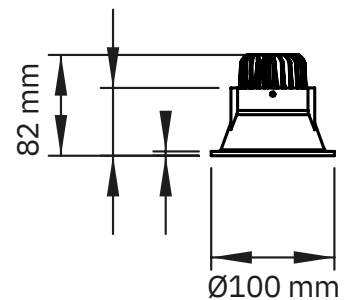

Art. No.	Watt	Lumen	CCT	Dimensions (QxH) mm.	Cut-out (mm.)	Weight (kg.)
ISS-416-008-827	8W	780	2700K	100x82	90	0,4 kg.
ISS-416-008-830	8W	820	3000K	100x82	90	0,4 kg.
ISS-416-008-840	8W	900	4000K	100x82	90	0,4 kg.
ISS-416-008-865	8W	945	6500K	100x82	90	0,4 kg.
ISS-416-010-827	10W	960	2700K	100x82	90	0,4 kg.
ISS-416-010-830	10W	1010	3000K	100x82	90	0,4 kg.
ISS-416-010-840	10W	1100	4000K	100x82	90	0,4 kg.
ISS-416-010-865	10W	1220	6500K	100x82	90	0,4 kg.



# MYRA II

SKU: ISS-417 Categories: Interior, Spotlights



## FEATURES

### Mechanical

Body: Aluminium  
 Finish: Electrostatic powder painted  
 Installation: Ceiling recessed mounted  
 Diffuser: Transparent safety glass  
 Optics: Aluminium reflector

### Electrical

Driver: LED driver with external connections  
 Light source: COB LED  
 Frequency: 220-240V 50/60 Hz  
 Lifetime: 50.000 hours  
 P<sub>f</sub>>0.90  
 Operating Temperature: -20 / +50

### Options

RAL selection  
 CRI>90  
 CRI>97  
 DALI  
 0-10V / 1-10V  
 Casambi  
 Emergency kit /  
 CBS connection  
 GST connector  
 Honeycomb louvre

### Optical

Beam angle: 15-30-45-60 degrees  
 UGR: <21  
 CRI>90  
 McAdams Step<3

## Specifications

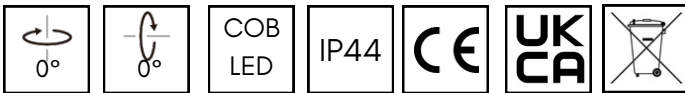

## Photometric Data

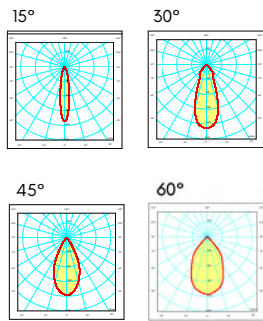

## CCT Values



## Technical Drawing

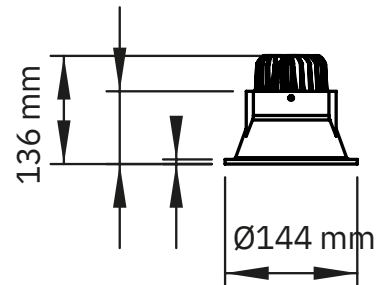

Art. No.	Watt	Lumen	CCT	Dimensions (QxH) mm.	Cut-out (mm.)	Weight (kg.)
ISS-417-020-827	20W	2080	2700K	144x136	135	0,9 kg.
ISS-417-020-830	20W	2210	3000K	144x136	135	0,9 kg.
ISS-417-020-840	20W	2300	4000K	144x136	135	0,9 kg.
ISS-417-020-865	20W	2440	6500K	144x136	135	0,9 kg.
ISS-417-030-827	30W	3000	2700K	144x136	135	0,9 kg.
ISS-417-030-830	30W	3150	3000K	144x136	135	0,9 kg.
ISS-417-030-840	30W	3280	4000K	144x136	135	0,9 kg.
ISS-417-030-865	30W	3400	6500K	144x136	135	0,9 kg.

# MYRA III

SKU: ISS-418 Categories: Interior, Spotlights



## FEATURES

### Mechanical

Body: Aluminium  
Finish: Electrostatic powder painted  
Installation: Ceiling recessed mounted  
Diffuser: Transparent safety glass  
Optics: Aluminium reflector

### Electrical

Driver: LED driver with external connections  
Light source: COB LED  
Frequency: 220-240V 50/60 Hz  
Lifetime: 50.000 hours  
Pfc: 0.90  
Operating Temperature: -20 / +50

### Options

RAL selection  
CRI>90  
CRI>97  
DALI  
0-10V / 1-10V  
Casambi  
Emergency kit / CBS connection  
GST connector  
Honeycomb louvre

### Optical

Beam angle: 15-30-45-60 degrees  
UGR: <21  
CRI>90  
McAdams Step<3

## Specifications

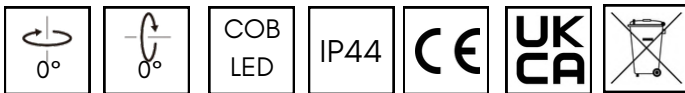

## Photometric Data

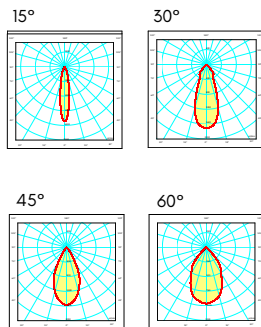

## CCT Values



## Technical Drawing

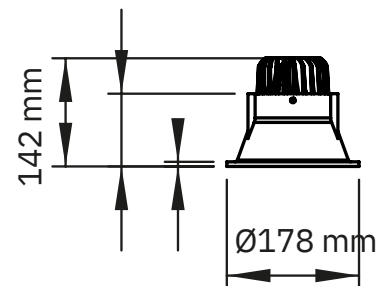

Art. No.	Watt	Lumen	CCT	Dimensions (QxH) mm.	Cut-out (mm.)	Weight (kg.)
ISS-418-030-827	30W	3000	2700K	178x142	170	1,2 kg.
ISS-418-030-830	30W	3150	3000K	178x142	170	1,2 kg.
ISS-418-030-840	30W	3280	4000K	178x142	170	1,2 kg.
ISS-418-030-865	30W	3400	6500K	178x142	170	1,2 kg.
ISS-418-040-827	40W	4080	2700K	178x142	170	1,2 kg.
ISS-418-040-830	40W	4200	3000K	178x142	170	1,2 kg.
ISS-418-040-840	40W	4370	4000K	178x142	170	1,2 kg.
ISS-418-040-865	40W	4500	6500K	178x142	170	1,2 kg.

# MYRA-T I

SKU: ISS-454 Categories: [Interior](#), [Trimless Series](#)



## FEATURES

### Mechanical

Body: Aluminium  
 Finish: Electrostatic powder painted  
 Installation: Trimless recessed mounted  
 Diffuser: Transparent safety glass  
 Optics: Aluminium reflector

### Electrical

Driver: LED driver with external connection  
 Light source: COB LED  
 Frequency: 220-240V 50/60 Hz  
 Lifetime: 50.000 hours  
 P<sub>f</sub>: 0.90  
 Operating Temperature: -20 / +50

### Options

RAL selection  
 CRI>90  
 CRI>97  
 DALI  
 0-10V / 1-10V  
 Casambi  
 Emergency kit /  
 CBS connection  
 GST connector

### Optical

Beam angle: 15-30-45 degrees  
 UGR: <21  
 CRI>80  
 McAdams Step<3

## Specifications



## Photometric Data

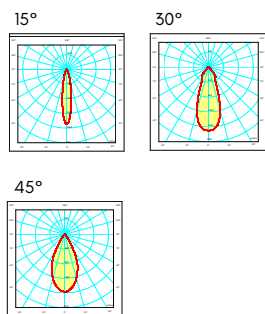

## CCT Values



## Technical Drawing

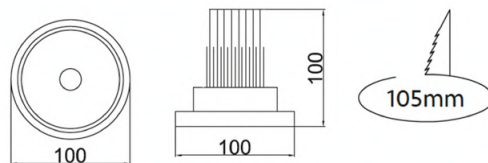

Art. No.	Watt	Lumen	CCT	Dimensions (QxH) mm.	Cut-out (mm.)	Weight (kg.)
ISS-454-008-827	8W	850	2700K	100x100	105	0,4 kg.
ISS-454-008-830	8W	1000	3000K	100x100	105	0,4 kg.
ISS-454-008-840	8W	1130	4000K	100x100	105	0,4 kg.
ISS-454-008-865	8W	1280	6500K	100x100	105	0,4 kg.

# MYRA-T II

SKU: ISS-455 Categories: [Interior](#), [Trimless Series](#)



## FEATURES

### Mechanical

Body: Aluminium  
Finish: Electrostatic powder painted  
Installation: Trimless recessed mounted  
Diffuser: Transparent safety glass  
Optics: Aluminium reflector

### Electrical

Driver: LED driver with external connection  
Light source: COB LED  
Frequency: 220-240V 50/60 Hz  
Lifetime: 50.000 hours  
Pf>0.90  
Operating Temperature: -20 / +50

### Options

RAL selection  
CRI>90  
CRI>97  
DALI  
0-10V / 1-10V  
Casambi  
Emergency kit /  
CBS connection  
GST connector

### Optical

Beam angle: 15-30-45 degrees  
UGR: <21  
CRI>80  
McAdams Step<3

## Specifications



## Photometric Data

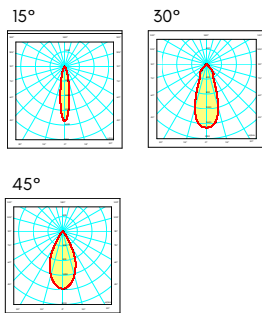

## CCT Values



## Technical Drawing

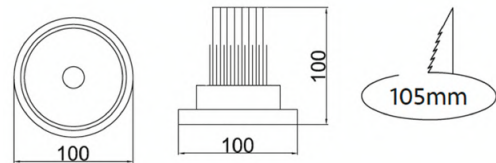

Art. No.	Watt	Lumen	CCT	Dimensions (QxH) mm.	Cut-out (mm.)	Weight (kg.)
ISS-455-208-827	2x8W	1700	2700K	100x100	105	0,4 kg.
ISS-455-208-830	2x8W	2000	3000K	100x100	105	0,4 kg.
ISS-455-208-840	2x8W	2260	4000K	100x100	105	0,4 kg.
ISS-455-208-865	2x8W	2560	6500K	100x100	105	0,4 kg.

# MYRA-TA

SKU: ISS-456 Categories: [Interior](#), [Trimless Series](#)



## FEATURES

### Mechanical

Body: Aluminium  
 Finish: Electrostatic powder painted  
 Installation: Trimless recessed mounted  
 Optics: Aluminium reflector

### Electrical

Driver: LED driver with external connection  
 Light source: COB LED  
 Frequency: 220-240V 50/60 Hz  
 Lifetime: 50.000 hours  
 Pf>0,90  
 Operating Temperature: -20 / +50

### Options

RAL selection  
 CRI>90  
 CRI>97  
 DALI  
 0-10V / 1-10V  
 Casambi  
 Emergency kit /  
 CBS connection  
 GST connector

### Optical

Beam angle: 15-30-45 degrees  
 Light Effect: Asymmetrical  
 UGR: <21  
 CRI>80  
 McAdams Step<3

## Specifications



## Photometric Data

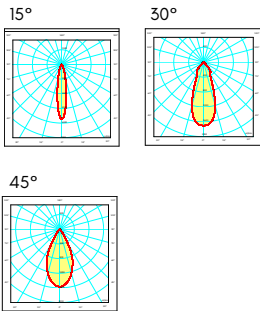

## CCT Values

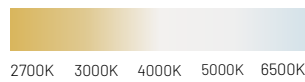

## Technical Drawing

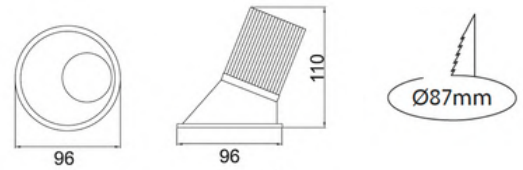

Art. No.	Watt	Lumen	CCT	Dimensions (QxH) mm.	Cut-out (mm.)	Weight (kg.)
ISS-456-008-827	8W	720	2700K	96x100	87	0,4 kg.
ISS-456-008-830	8W	815	3000K	96x100	87	0,4 kg.
ISS-456-008-840	8W	900	4000K	96x100	87	0,4 kg.
ISS-456-008-865	8W	1050	6500K	96x100	87	0,4 kg.



# MYRA-TB

SKU: ISS-457 Categories: [Interior](#), [Trimless Series](#)



## FEATURES

### Mechanical

Body: Aluminium  
 Finish: Electrostatic powder painted  
 Installation: Trimless recessed mounted  
 Diffuser: Transparent safety glass  
 Optics: Aluminium reflector  
 Louvre: Dark or gold louvre options

### Electrical

Driver: LED driver with external connection  
 Light source: COB LED  
 Frequency: 220-240V 50/60 Hz  
 Lifetime: 50.000 hours  
 P<sub>f</sub>>0.90  
 Operating Temperature: -20 / +50

### Options

RAL selection  
 CRI>90  
 CRI>97  
 DALI  
 0-10V / 1-10V  
 Casambi  
 Emergency kit /  
 CBS connection  
 GST connector

### Optical

Beam angle: 15-30-45 degrees  
 UGR: <19  
 CRI>80  
 McAdams Step<3

## Specifications



## Photometric Data

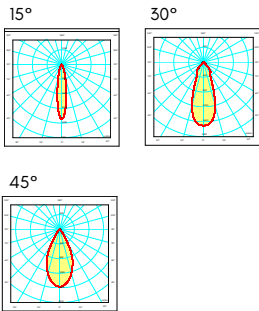

## CCT Values



## Technical Drawing

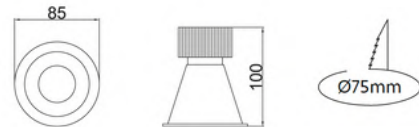

Art. No.	Watt	Lumen	CCT	Dimensions (QxH) mm.	Cut-out (mm.)	Weight (kg.)
ISS-457-008-827	8W	850	2700K	85x100	75	0,4 kg.
ISS-457-008-830	8W	1000	3000K	85x100	75	0,4 kg.
ISS-457-008-840	8W	1130	4000K	85x100	75	0,4 kg.
ISS-457-008-865	8W	1280	6500K	85x100	75	0,4 kg.



# Troy

Spotlight Series



# TROY I

SKU: IDS-504 Categories: [Downlights](#), [Interior](#)

**NERA**  
LIGHT



## FEATURES

### Mechanical

Body: Aluminium  
Finish: Electrostatic powder painted  
Installation: Ceiling recessed  
Diffuser: Transparent safety glass  
Optics: Aluminium reflector

### Electrical

Driver: LED driver with external connection  
Light source: COB LED  
Frequency: 220-240V 50/60 Hz  
Lifetime: 50.000 hours  
P<sub>f</sub>>0.90  
Operating Temperature: -20 / +50

### Options

RAL selection  
CRI>90  
CRI>97  
DALI  
0-10V / 1-10V  
Casambi  
Emergency kit / CBS connection  
GST connector

### Optical

Beam angle: 15-30 degrees options  
UGR: <21  
CRI>80  
McAdams Step<3

## Specifications

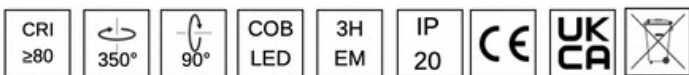

## Photometric Data

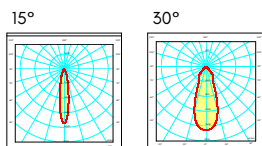

## CCT Values



## Technical Drawing

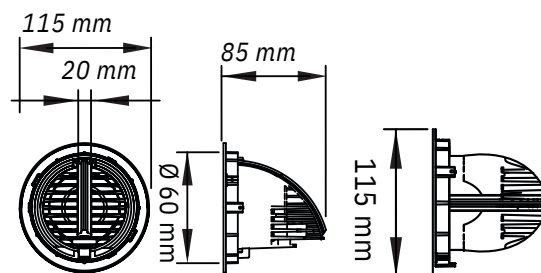

Art. No.	Watt	Lumen	CCT	Dimensions (WxLxH) mm.	Cut-out (mm.)	Weight (kg.)
ISS-415-010-827	10W	1050	2700K	115x115x85	100	0,4 kg.
ISS-415-010-830	10W	1130	3000K	115x115x85	100	0,4 kg.
ISS-415-010-840	10W	1200	4000K	115x115x85	100	0,4 kg.
ISS-415-010-865	10W	1250	6500K	115x115x85	100	0,4 kg.

# TROY II

SKU: ISS-414 Categories: [Interior](#), [Spotlights](#)



## FEATURES

### Mechanical

Body: Aluminium  
Finish: Electrostatic powder painted  
Installation: Ceiling recessed  
Diffuser: Transparent safety glass  
Optics: Aluminium reflector

### Electrical

Driver: LED driver with external connection  
Light source: COB LED  
Frequency: 220-240V 50/60 Hz  
Lifetime: 50.000 hours  
P<sub>f</sub>>0.90  
Operating Temperature: -20 / +50

### Options

RAL selection  
CRI>90  
CRI>97  
DALI  
0-10V / 1-10V  
Casambi  
Emergency kit /  
CBS connection  
GST connector

### Optical

Beam angle: 15-30-45-60 degrees options  
UGR: <21  
CRI>80  
McAdams Step<3

## Specifications



## Photometric Data

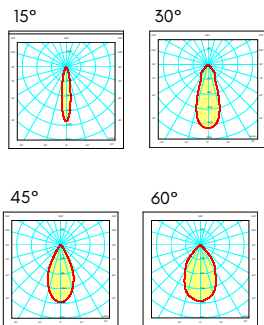

## CCT Values

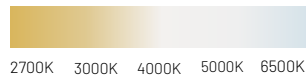

## Technical Drawing

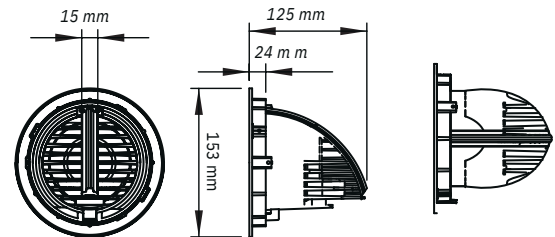

Art. No.	Watt	Lumen	CCT	Dimensions (WxLxH) mm.	Cut-out (mm.)	Weight (kg.)
ISS-415-020-827	20W	2100	2700K	153x153x125	145	0,9 kg.
ISS-415-020-830	20W	2260	3000K	153x153x125	145	0,9 kg.
ISS-415-020-840	20W	2400	4000K	153x153x125	145	0,9 kg.
ISS-415-020-865	20W	2500	6500K	153x153x125	145	0,9 kg.
ISS-415-030-827	30W	3000	2700K	153x153x125	145	0,9 kg.
ISS-415-030-830	30W	3150	3000K	153x153x125	145	0,9 kg.
ISS-415-030-840	30W	3300	4000K	153x153x125	145	0,9 kg.
ISS-415-030-865	30W	3420	6500K	153x153x125	145	0,9 kg.

# TROY III

SKU: ISS-413 Categories: [Interior](#), [Spotlights](#)



## FEATURES

### Mechanical

Body: Aluminium  
Finish: Electrostatic powder painted  
Installation: Ceiling recessed  
Diffuser: Transparent safety glass  
Optics: Aluminium reflector

### Electrical

Driver: LED driver with external connection  
Light source: COB LED  
Frequency: 220-240V 50/60 Hz  
Lifetime: 50.000 hours  
P<sub>f</sub>>0.90  
Operating Temperature: -20 / +50

### Options

RAL selection  
CRI>90  
CRI>97  
DALI  
0-10V / 1-10V  
Casambi  
Emergency kit / CBS connection  
GST connector

### Optical

Beam angle: 15-30-45-60 degrees options  
UGR: <21  
CRI>80  
McAdams Step<3

## Specifications



## Photometric Data

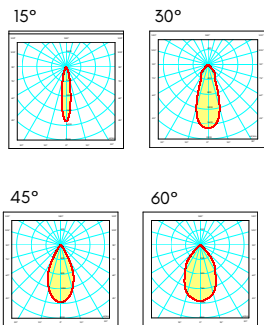

## CCT Values

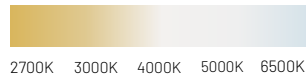

## Technical Drawing

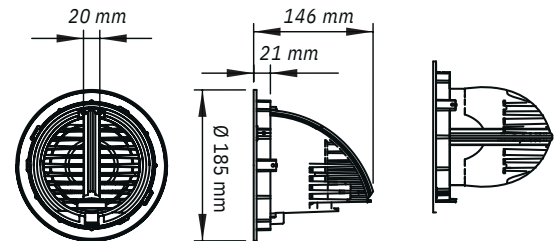

Art. No.	Watt	Lumen	CCT	Dimensions (WxLxH) mm.	Cut-out (mm.)	Weight (kg.)
ISS-413-020-827	20W	2100	2700K	185x185x146	170	1,33 kg.
ISS-413-020-830	20W	2260	3000K	185x185x146	170	1,33 kg.
ISS-413-020-840	20W	2400	4000K	185x185x146	170	1,33 kg.
ISS-413-020-865	20W	2500	6500K	185x185x146	170	1,33 kg.
ISS-413-030-827	30W	3000	2700K	185x185x146	170	1,33 kg.
ISS-413-030-830	30W	3150	3000K	185x185x146	170	1,33 kg.
ISS-413-030-840	30W	3300	4000K	185x185x146	170	1,33 kg.
ISS-413-030-865	30W	3420	6500K	185x185x146	170	1,33 kg.





# Cymes

## Spotlight Series



# CYMES-L I

SKU: ISS-426 Categories: [Interior](#), [Spotlights](#)



## FEATURES

### Mechanical

Body: Aluminium  
Finish: Electrostatic powder painted  
Installation: Ceiling recessed  
Diffuser: Transparent safety glass  
Optics: Aluminium reflector

### Electrical

Driver: LED driver with external connection  
Light source: COB LED  
Frequency: 220-240V 50/60 Hz  
Lifetime: 50.000 hours  
P<sub>f</sub>>0.90  
Operating Temperature: -20 / +50

### Options

RAL selection  
CRI>90  
CRI>97  
DALI  
0-10V / 1-10V  
Casambi  
Emergency kit / CBS connection  
GST connector

### Optical

Beam angle: 15-30-45-60 degrees options  
UGR: <21  
CRI>80  
McAdams Step<3

## Specifications

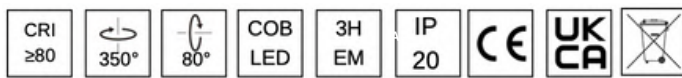

## Photometric Data

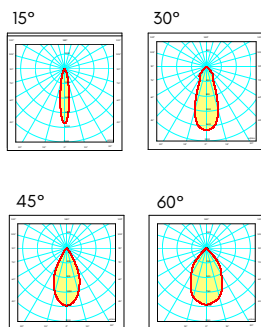

## CCT Values

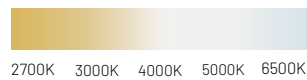

## Technical Drawing

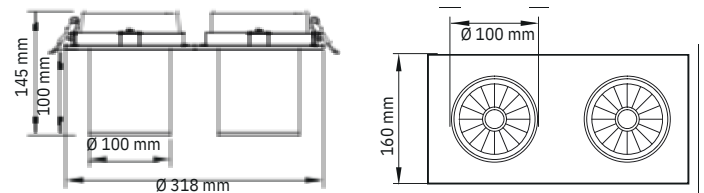

Art. No.	Watt	Lumen	CCT	Dimensions (WxLxH) mm.	Cut-out (mm.)	Weight (kg.)
ISS-426-030-827	30W	3300	2700K	160x160x145	145X145	1,1 kg.
ISS-426-030-830	30W	3430	3000K	160x160x145	145X145	1,1 kg.
ISS-426-030-840	30W	3600	4000K	160x160x145	145X145	1,1 kg.
ISS-426-030-865	30W	3750	6500K	160x160x145	145X145	1,1 kg.

# CYMES-L I

SKU: ISS-426 Categories: [Interior](#), [Spotlights](#)



## FEATURES

### Mechanical

Body: Aluminium  
Finish: Electrostatic powder painted  
Installation: Ceiling recessed  
Diffuser: Transparent safety glass  
Optics: Aluminium reflector

### Electrical

Driver: LED driver with external connection  
Light source: COB LED  
Frequency: 220-240V 50/60 Hz  
Lifetime: 50.000 hours  
P<sub>f</sub>>0.90  
Operating Temperature: -20 / +50

### Options

RAL selection  
CRI>90  
CRI>97  
DALI  
0-10V / 1-10V  
Casambi  
Emergency kit / CBS connection  
GST connector

### Optical

Beam angle: 15-30-45-60 degrees options  
UGR: <21  
CRI>80  
McAdams Step<3

## Specifications

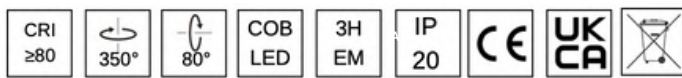

## Photometric Data

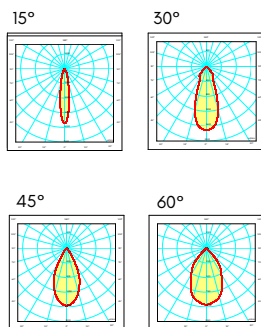

## CCT Values

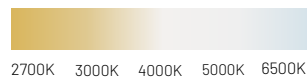

## Technical Drawing

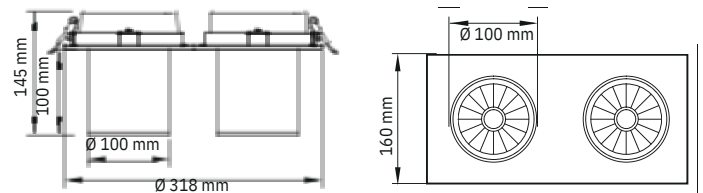

Art. No.	Watt	Lumen	CCT	Dimensions (WxLxH) mm.	Cut-out (mm.)	Weight (kg.)
ISS-426-030-827	30W	3300	2700K	160x160x145	145X145	1,1 kg.
ISS-426-030-830	30W	3430	3000K	160x160x145	145X145	1,1 kg.
ISS-426-030-840	30W	3600	4000K	160x160x145	145X145	1,1 kg.
ISS-426-030-865	30W	3750	6500K	160x160x145	145X145	1,1 kg.

# CYMES-M I

SKU: ISS-428 Categories: [Interior](#), [Spotlights](#)



## FEATURES

### Mechanical

Body: Aluminium  
Finish: Electrostatic powder painted  
Installation: Ceiling recessed  
Diffuser: Transparent safety glass  
Optics: Aluminium reflector

### Electrical

Driver: LED driver with external connection  
Light source: COB LED  
Frequency: 220-240V 50/60 Hz  
Lifetime: 50.000 hours  
Pf>0.90  
Operating Temperature: -20 / +50

### Options

RAL selection  
CRI>90  
CRI>97  
DALI  
0-10V / 1-10V  
Casambi  
Emergency kit /  
CBS connection  
GST connector

### Optical

Beam angle: 15-30-45 degrees options  
UGR: <21  
CRI>80  
McAdams Step<3

## Specifications

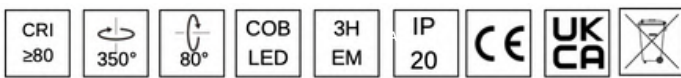

## Photometric Data

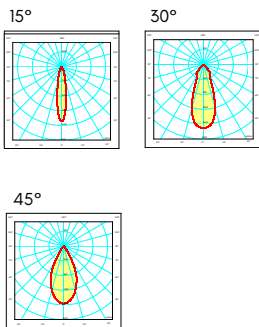

## CCT Values

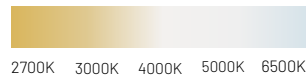

## Technical Drawing

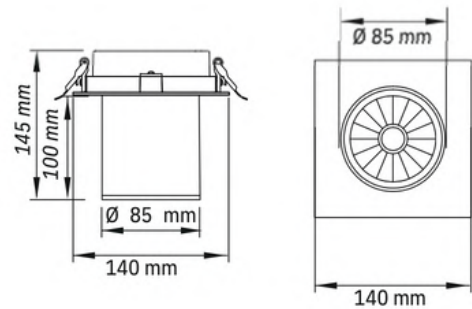

Art. No.	Watt	Lumen	CCT	Dimensions (WxLxH) mm.	Cut-out (mm.)	Weight (kg.)
ISS-428-015-827	15W	1620	2700K	140x140x145	120x120	0,9 kg.
ISS-428-015-830	15W	1700	3000K	140x140x145	120x120	0,9 kg.
ISS-428-015-840	15W	1775	4000K	140x140x145	120x120	0,9 kg.
ISS-428-015-865	15W	1860	6500K	140x140x145	120x120	0,9 kg.
ISS-428-020-827	20W	2200	2700K	140x140x145	120x120	0,9 kg.
ISS-428-020-830	20W	2350	3000K	140x140x145	120x120	0,9 kg.
ISS-428-020-840	20W	2430	4000K	140x140x145	120x120	0,9 kg.
ISS-428-020-865	20W	2500	6500K	140x140x145	120x120	0,9 kg.

# CYMES-M II

SKU: ISS-429 Categories: [Interior](#), [Spotlights](#)



## FEATURES

### Mechanical

Body: Aluminium  
Finish: Electrostatic powder painted  
Installation: Ceiling recessed  
Diffuser: Transparent safety glass  
Optics: Aluminium reflector

### Electrical

Driver: LED driver with external connection  
Light source: COB LED  
Frequency: 220-240V 50/60 Hz  
Lifetime: 50.000 hours  
P<sub>f</sub>>0.90  
Operating Temperature: -20 / +50

### Options

RAL selection  
CRI>90  
CRI>97  
DALI  
0-10V / 1-10V  
Casambi  
Emergency kit /  
CBS connection  
GST connector

### Optical

Beam angle: 15-30-45 degrees options  
UGR: <21  
CRI>80  
McAdams Step<3

## Specifications

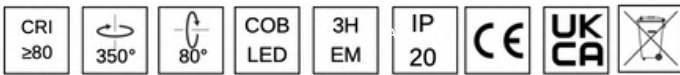

## Photometric Data

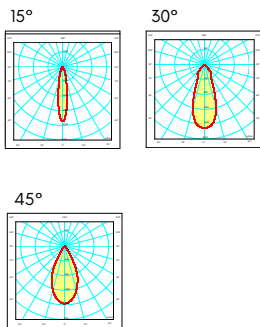

## CCT Values

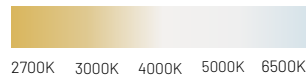

## Technical Drawing

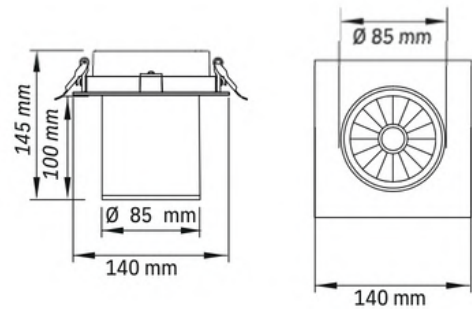

Art. No.	Watt	Lumen	CCT	Dimensions (WxLxH) mm.	Cut-out (mm.)	Weight (kg.)
ISS-429-030-827	2x15W	3240	2700K	140x280x145	120x265	1,9 kg.
ISS-429-030-830	2x15W	3400	3000K	140x280x145	120x265	1,9 kg.
ISS-429-030-840	2x15W	3550	4000K	140x280x145	120x265	1,9 kg.
ISS-429-030-865	2x15W	3720	6500K	140x280x145	120x265	1,9 kg.
ISS-429-040-827	2x20W	4400	2700K	140x280x145	120x265	1,9 kg.
ISS-429-040-830	2x20W	4700	3000K	140x280x145	120x265	1,9 kg.
ISS-429-040-840	20W	4860	4000K	140x280x145	120x265	1,9 kg.
ISS-429-040-865	2x20W	5000	6500K	140x280x145	120x265	1,9 kg.



# CYMES-S-I

SKU: ISS-430 Categories: [Interior](#), [Spotlights](#)



## FEATURES

### Mechanical

Body: Aluminium  
Finish: Electrostatic powder painted  
Installation: Ceiling recessed  
Diffuser: Transparent safety glass  
Optics: Aluminium reflector

### Electrical

Driver: LED driver with external connection  
Light source: COB LED  
Frequency: 220-240V 50/60 Hz  
Lifetime: 50.000 hours  
P<sub>f</sub>>0.90  
Operating Temperature: -20 / +50

### Options

RAL selection  
CRI>90  
CRI>97  
DALI  
0-10V / 1-10V  
Casambi  
Emergency kit /  
CBS connection  
GST connector

### Optical

Beam angle: 15-30-45 degrees  
options  
UGR: <21  
CRI>80  
McAdams Step<3

## Specifications

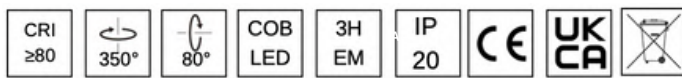

## Photometric Data

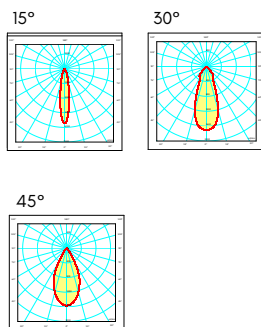

## CCT Values

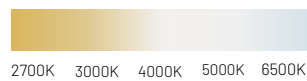

## Technical Drawing

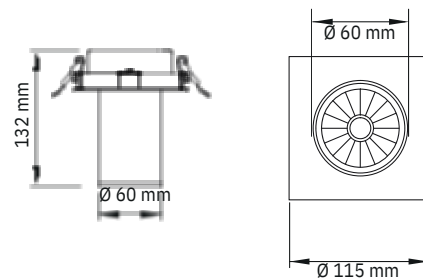

Art. No.	Watt	Lumen	CCT	Dimensions (WxLxH) mm.	Cut-out (mm.)	Weight (kg.)
ISS-430-010-827	10W	1130	2700K	115x115x132	100x100	0,5 kg.
ISS-430-010-830	10W	1190	3000K	115x115x132	100x100	0,5 kg.
ISS-430-010-840	10W	1250	4000K	115x115x132	100x100	0,5 kg.
ISS-430-010-865	10W	1300	6500K	115x115x132	100x100	0,5 kg.

# CYMES-S-II

SKU: ISS-431 Categories: [Interior](#), [Spotlights](#)



## FEATURES

### Mechanical

Body: Aluminium  
Finish: Electrostatic powder painted  
Installation: Ceiling recessed  
Diffuser: Transparent safety glass  
Optics: Aluminium reflector

### Electrical

Driver: LED driver with external connection  
Light source: COB LED  
Frequency: 220-240V 50/60 Hz  
Lifetime: 50.000 hours  
P<sub>f</sub>>0.90  
Operating Temperature: -20 / +50

### Options

RAL selection  
CRI>90  
CRI>97  
DALI  
0-10V / 1-10V  
Casambi  
Emergency kit /  
CBS connection  
GST connector

### Optical

Beam angle: 15-30-45 degrees options  
UGR: <21  
CRI>80  
McAdams Step<3

## Specifications

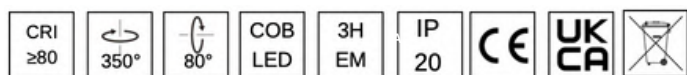

## Photometric Data

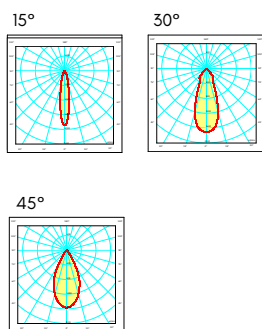

## CCT Values



## Technical Drawing

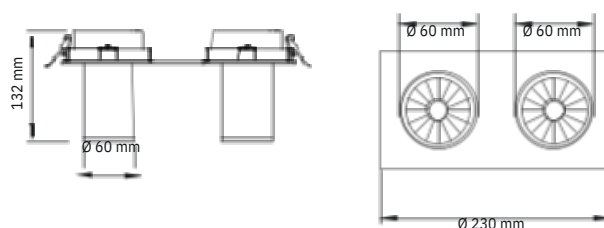

Art. No.	Watt	Lumen	CCT	Dimensions (WxLxH) mm.	Cut-out (mm.)	Weight (kg.)
ISS-431-020-827	2x10W	2260	2700K	115x230x132	100x215	0,9 kg.
ISS-431-020-830	2x10W	2380	3000K	115x230x132	100x215	0,9 kg.
ISS-431-020-840	2x10W	2500	4000K	115x230x132	100x215	0,9 kg.
ISS-431-020-865	2x10W	2600	6500K	115x230x132	100x215	0,9 kg.



# Eros

Spotlight Series





## FEATURES

### Mechanical

Body: Aluminium  
 Finish: Electrostatic powder painted  
 Installation: Ceiling surface mounted  
 Diffuser: Transparent safety glass  
 Optics: Aluminium reflector

### Options

RAL selection  
 CRI>90  
 CRI>97  
 DALI  
 Suspension accessory

### Electrical

Driver: LED driver integrated to housing  
 Light source: COB LED  
 Frequency: 220-240V 50/60 Hz  
 Lifetime: 50.000 hours  
 P<sub>f</sub>>0.90  
 Operating Temperature: -20 / +50

### Optical

Beam angle: 15-30 degree options  
 UGR: <21  
 CRI>90  
 McAdams Step<3

## Specifications

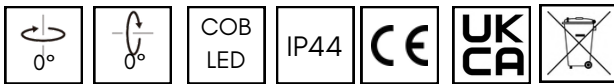

## Light Beam

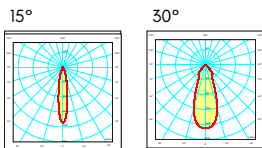

## CCT Values



## Technical Drawing

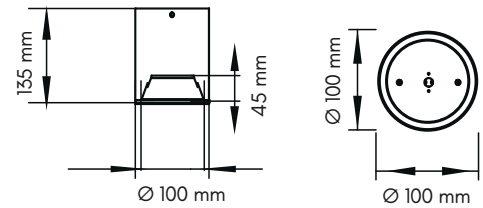

Art. No.	Watt	Lumen	CCT	Dimensions (QxH) mm.	Cut-out (mm.)	Weight (kg.)
ISS-442-010-827	10W	1010	2700K	100x135	N/A	0,6 kg.
ISS-442-010-830	10W	1100	3000K	100x135	N/A	0,6 kg.
ISS-442-010-840	10W	1240	4000K	100x135	N/A	0,6 kg.
ISS-442-010-865	10W	1300	6500K	100x135	N/A	0,6 kg.



## FEATURES

### Mechanical

Body: Aluminium  
 Finish: Electrostatic powder painted  
 Installation: Ceiling surface mounted  
 Diffuser: Transparent safety glass  
 Optics: Aluminium reflector

### Options

RAL selection  
 CRI>90  
 CRI>97  
 DALI  
 Suspension accessory

### Electrical

Driver: LED driver integrated to housing  
 Light source: COB LED  
 Frequency: 220-240V 50/60 Hz  
 Lifetime: 50.000 hours  
 P<sub>f</sub>>0.90  
 Operating Temperature: -20 / +50

### Optical

Beam angle: 15-30 degree options  
 UGR: <21  
 CRI>90  
 McAdams Step<3

## Specifications

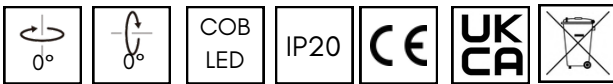

## Light Beam

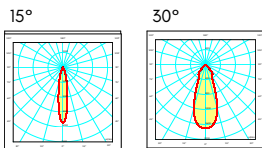

## CCT Values



## Technical Drawing

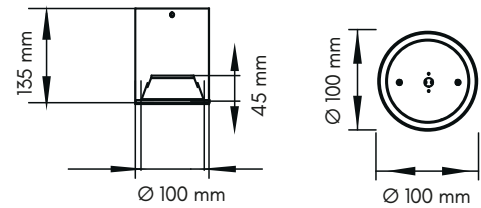

Art. No.	Watt	Lumen	CCT	Dimensions (QxH) mm.	Cut-out (mm.)	Weight (kg.)
ISS-442-007-827	7W	665	2700K	100x135	N/A	0,6 kg.
ISS-442-007-830	7W	710	3000K	100x135	N/A	0,6 kg.
ISS-442-007-840	7W	780	4000K	100x135	N/A	0,6 kg.
ISS-442-007-865	7W	910	6500K	100x135	N/A	0,6 kg.





## FEATURES

### Mechanical

Body: Aluminium  
 Finish: Electrostatic powder painted  
 Installation: Ceiling surface mounted  
 Diffuser: Transparent safety glass  
 Optics: Aluminium reflector

### Options

RAL selection  
 CRI>90  
 CRI>97  
 Suspension accessory

### Electrical

Driver: LED driver integrated to housing  
 Light source: COB LED  
 Frequency: 220-240V 50/60 Hz  
 Lifetime: 50.000 hours  
 Pfc>0.90  
 Operating Temperature: -20 / +50

### Optical

Beam angle: 30 degree  
 UGR: <21  
 CRI>90  
 McAdams Step<3

## Specifications

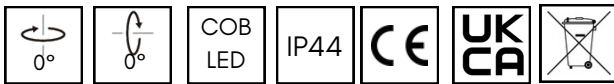

## Light Beam

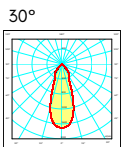

## CCT Values



## Technical Drawing

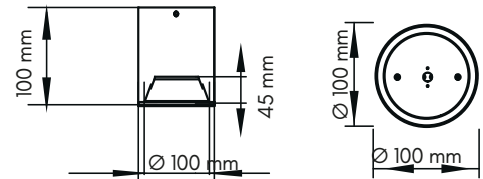

Art. No.	Watt	Lumen	CCT	Dimensions (QxH) mm.	Cut-out (mm.)	Weight (kg.)
ISS-443-006-827	7W	560	2700K	100x100	N/A	0,5 kg.
ISS-443-006-830	7W	610	3000K	100x100	N/A	0,5 kg.
ISS-443-006-840	7W	680	4000K	100x100	N/A	0,5 kg.
ISS-443-006-865	7W	720	6500K	100x100	N/A	0,5 kg.



## FEATURES

### Mechanical

Body: Aluminium  
 Finish: Electrostatic powder painted  
 Installation: Ceiling surface mounted  
 Diffuser: Transparent safety glass  
 Optics: Aluminium reflector

### Options

RAL selection  
 CRI>90  
 CRI>97  
 DALI  
 Suspension accessory

### Electrical

Driver: LED driver integrated to housing  
 Light source: COB LED  
 Frequency: 220-240V 50/60 Hz  
 Lifetime: 50.000 hours  
 P<sub>f</sub>>0.90  
 Operating Temperature: -20 / +50

### Optical

Beam angle: 15-30 degree options  
 UGR: <21  
 CRI>90  
 McAdams Step<3

## Specifications

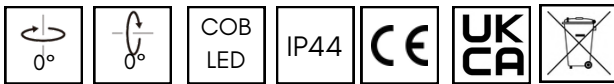

## Light Beam

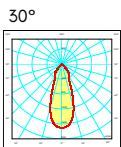

## CCT Values



## Technical Drawing

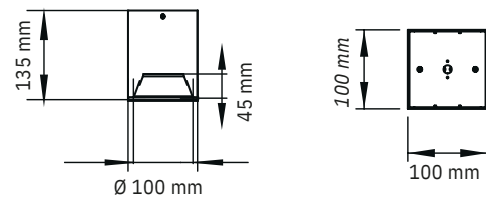

Art. No.	Watt	Lumen	CCT	Dimensions (QxH) mm.	Cut-out (mm.)	Weight (kg.)
ISS-444-010-827	10W	1010	2700K	100x135	N/A	0,6 kg.
ISS-444-010-830	10W	1100	3000K	100x135	N/A	0,6 kg.
ISS-444-010-840	10W	1240	4000K	100x135	N/A	0,6 kg.
ISS-444-010-865	10W	1300	6500K	100x135	N/A	0,6 kg.



# Echo

Spotlight Series





## FEATURES

### Mechanical

Body: Aluminium  
 Finish: Electrostatic powder painted  
 Installation: Ceiling surface mounted  
 Diffuser: Transparent safety glass  
 Optics: Aluminium reflector

### Options

RAL selection  
 CRI>90  
 CRI>97  
 DALI  
 Suspension accessory

### Electrical

Driver: LED driver inside housing  
 Light source: COB LED  
 Frequency: 220-240V 50/60 Hz  
 Lifetime: 50.000 hours  
 Pfc>0.90  
 Operating Temperature: -20 / +50

### Optical

Beam angle: 15-30-45 degree options  
 UGR: <21  
 CRI>90  
 McAdams Step<3

## Specifications

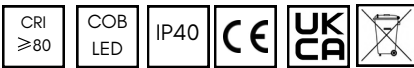

## Light Beam

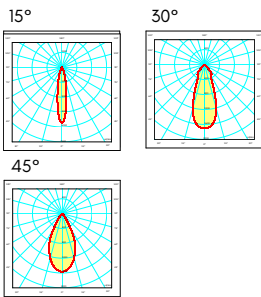

## CCT Values



## Technical Drawing

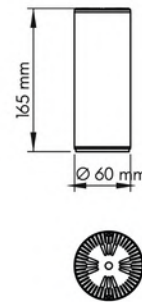

Art. No.	Watt	Lumen	CCT	Dimensions (QxH) mm.	Cut-out (mm.)	Weight (kg.)
ISS-435-010-827	10W	1010	3000K	60x165	N/A	0,5 kg.
ISS-435-010-830	10W	1120	4000K	60x165	N/A	0,5 kg.
ISS-435-010-840	10W	1200	4000K	60x165	N/A	0,5 kg.
ISS-435-010-865	10W	1250	6500K	60x165	N/A	0,5 kg.



## FEATURES

### Mechanical

Body: Aluminium  
 Finish: Electrostatic powder painted  
 Installation: Ceiling surface mounted  
 Diffuser: Transparent safety glass  
 Optics: Aluminium reflector

### Options

RAL selection  
 CRI>90  
 CRI>97  
 DALI  
 Suspension accessory

### Electrical

Driver: LED driver inside housing  
 Light source: COB LED  
 Frequency: 220-240V 50/60 Hz  
 Lifetime: 50.000 hours  
 Pfc>0.90  
 Operating Temperature: -20 / +50

### Optical

Beam angle: 15-30-45 degree options  
 UGR: <21  
 CRI>90  
 McAdams Step<3

## Specifications

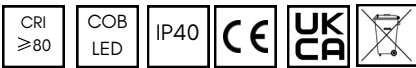

## Light Beam

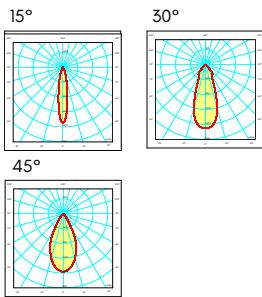

## CCT Values



## Technical Drawing

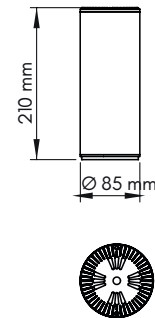

Art. No.	Watt	Lumen	CCT	Dimensions (QxH) mm.	Cut-out (mm.)	Weight (kg.)
ISS-434-015-827	15W	1500	2700K	85x210	N/A	0,7 kg.
ISS-434-015-830	15W	1570	3000K	85x210	N/A	0,7 kg.
ISS-434-015-840	15W	1620	4000K	85x210	N/A	0,7 kg.
ISS-434-015-865	15W	1660	6500K	85x210	N/A	0,7 kg.
ISS-434-020-827	20W	1985	2700K	85x210	N/A	0,7 kg.
ISS-434-020-830	20W	2030	3000K	85x210	N/A	0,7 kg.
ISS-434-020-840	20W	2100	4000K	85x210	N/A	0,7 kg.
ISS-434-020-865	20W	2170	6500K	85x210	N/A	0,7 kg.





## FEATURES

### Mechanical

Body: Aluminium  
 Finish: Electrostatic powder painted  
 Installation: Ceiling surface mounted  
 Diffuser: Transparent safety glass  
 Optics: Aluminium reflector

### Options

RAL selection  
 CRI>90  
 CRI>97  
 DALI  
 Suspension accessory

### Electrical

Driver: LED driver inside housing  
 Light source: COB LED  
 Frequency: 220-240V 50/60 Hz  
 Lifetime: 50.000 hours  
 Pfc>0.90  
 Operating Temperature: -20 / +50

### Optical

Beam angle: 15-30-45-60 degree options  
 UGR: <21  
 CRI>90  
 McAdams Step<3

## Specifications

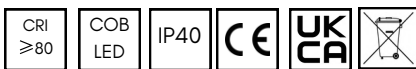

## Light Beam

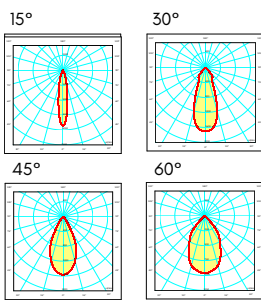

## CCT Values



## Technical Drawing

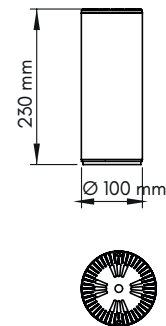

Art. No.	Watt	Lumen	CCT	Dimensions (QxH) mm.	Cut-out (mm.)	Weight (kg.)
ISS-433-020-827	20W	1985	2700K	100x230	N/A	1,0 kg.
ISS-433-020-830	20W	2030	3000K	100x230	N/A	1,0 kg.
ISS-433-020-840	20W	2100	4000K	100x230	N/A	1,0 kg.
ISS-433-020-865	20W	2170	6500K	100x230	N/A	1,0 kg.
ISS-433-030-827	30W	3010	2700K	100x230	N/A	1,0 kg.
ISS-433-030-830	30W	3150	3000K	100x230	N/A	1,0 kg.
ISS-433-030-840	30W	3300	4000K	100x230	N/A	1,0 kg.
ISS-433-030-865	30W	3430	6500K	100x230	N/A	1,0 kg.



## FEATURES

### Mechanical

Body: Aluminium  
 Finish: Electrostatic powder painted  
 Installation: Ceiling surface mounted  
 Diffuser: Transparent safety glass  
 Optics: Aluminium reflector

### Options

RAL selection  
 CRI>90  
 CRI>97  
 DALI  
 Suspension accessory

### Electrical

Driver: LED driver inside housing  
 Light source: COB LED  
 Frequency: 220-240V 50/60 Hz  
 Lifetime: 50.000 hours  
 Pfc>0.90  
 Operating Temperature: -20 / +50

### Optical

Beam angle: 15-30-45-60 degree options  
 UGR: <21  
 CRI>90  
 McAdams Step<3

## Specifications

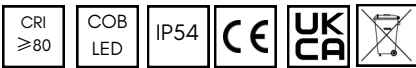

## Light Beam

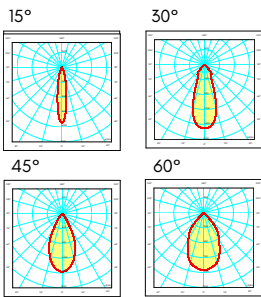

## CCT Values



## Technical Drawing

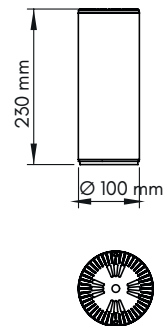

Art. No.	Watt	Lumen	CCT	Dimensions (QxH) mm.	Cut-out (mm.)	Weight (kg.)
ISS-432-030-827	30W	3010	2700K	118x230	N/A	1,1 kg.
ISS-432-030-830	30W	3150	3000K	118x230	N/A	1,1 kg.
ISS-432-030-840	30W	3300	4000K	118x230	N/A	1,1 kg.
ISS-432-030-865	30W	3430	6500K	118x230	N/A	1,1 kg.
ISS-432-035-827	35W	3530	2700K	118x230	N/A	1,1 kg.
ISS-432-035-830	35W	3700	3000K	118x230	N/A	1,1 kg.
ISS-432-035-840	35W	3900	4000K	118x230	N/A	1,1 kg.
ISS-432-035-865	35W	4090	6500K	118x230	N/A	1,1 kg.