

price list

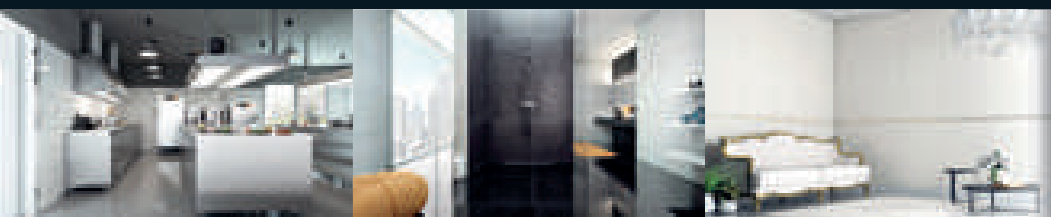

catalogue

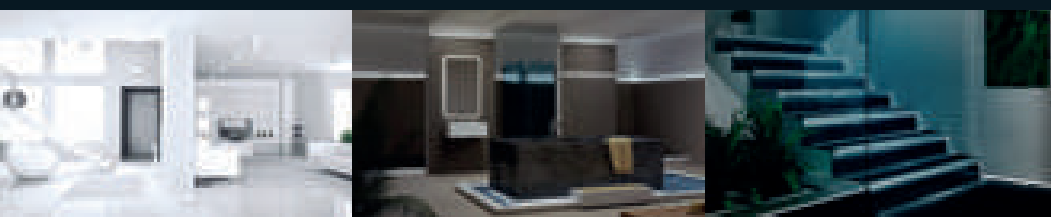

prices



2022_02

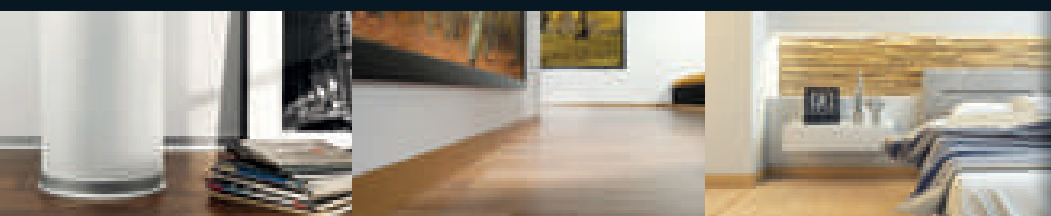

price list

catalogue

prices

2022_02

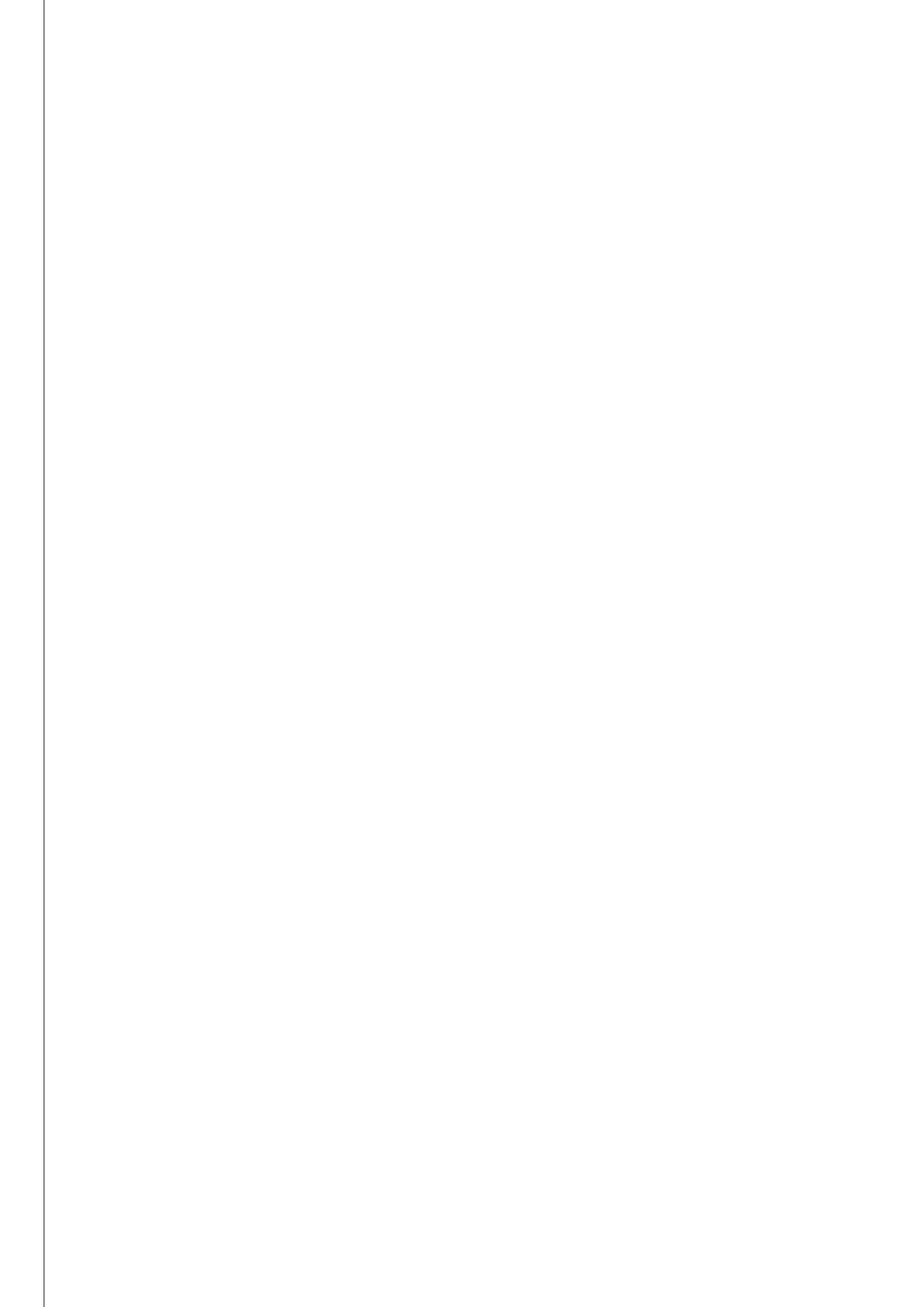

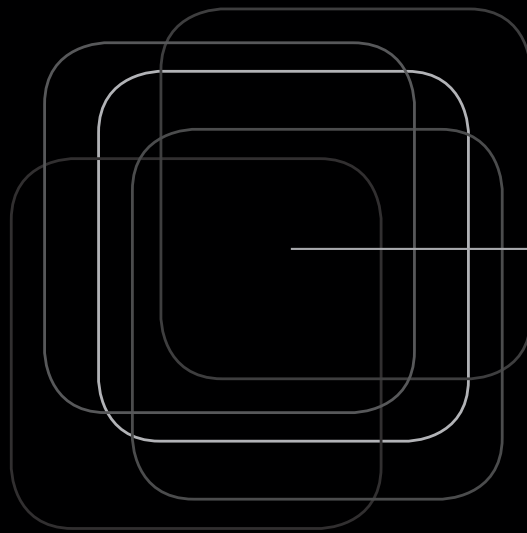



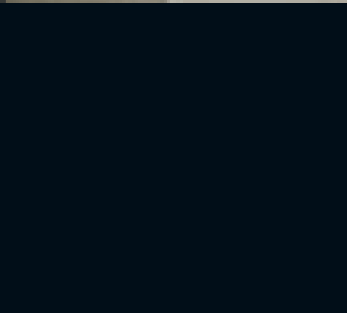
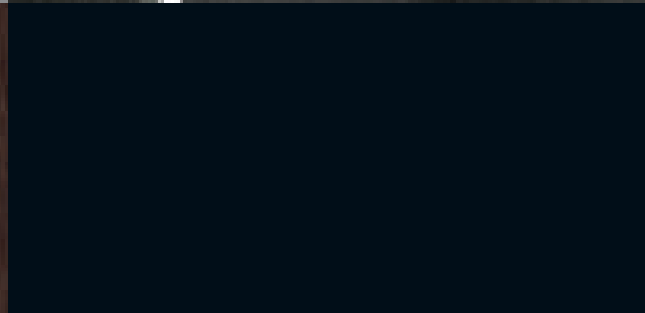
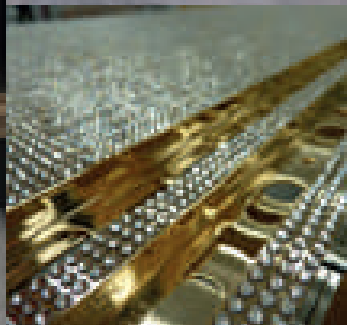
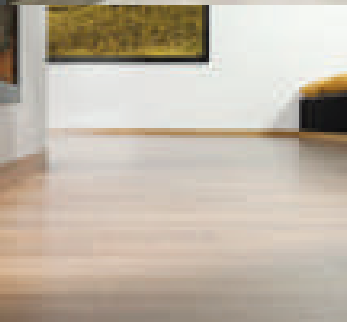
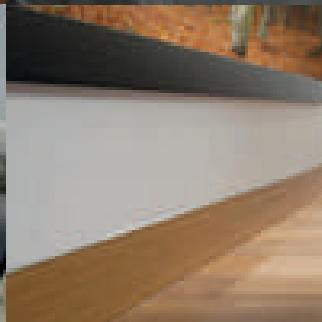
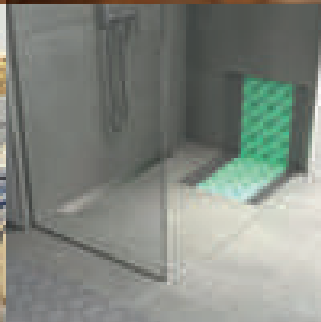
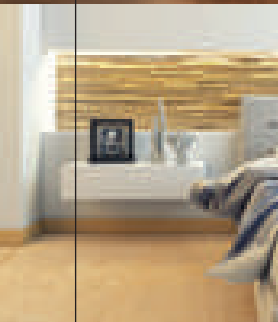
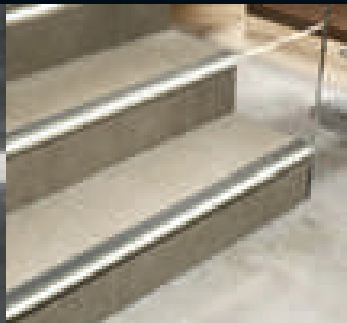
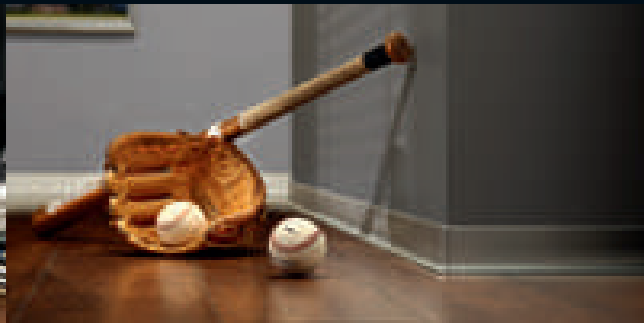





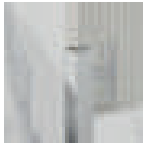



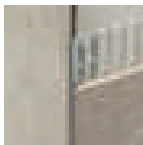

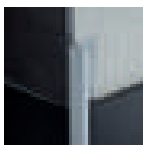



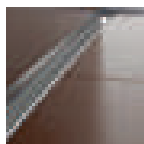

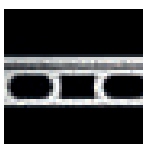
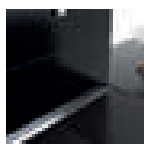

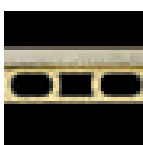

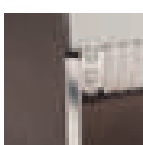

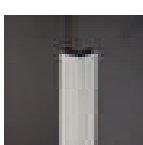

Design is our best profile.





Index

| | | | | | | | | | |
|---|---|---|---|---|---|---|---|---|--------------------------------|
| external corners profiles |  | CERFIX® PROANGLE Q page 18 |  | CERFIX® PROTOP page 47 |  | PROROUND B page 62 | | | |
| |  | CERFIX® PROANGLE page 26 | | | | | | | |
| |  | CERFIX® PROTRIM IP page 31 | listellos and decorative profiles |  | CERFIX® PROLIST page 50 | linear drains and bathroom systems |  | PP DRAIN AQUA page 68 | |
| |  | CERFIX® PROTRIM page 32 | |  | METAL LINE AF - M DESIGN page 51 | |  | THIN DRAIN page 73 | |
| |  | CERFIX® PROTRIM N page 35 | |  | CERFIX® PROLIST-X DESIGN page 51 | |  | SLIM DRAIN page 75 | |
| |  | CERFIX® PROANGLE F page 40 | |  | CERFIX® PRODECOR - C DESIGN page 52 | |  | SMART DRAIN page 77 | |
| |  | CERFIX® PROANGLE AX - M DESIGN page 41 | |  | CERFIX® PROSTYLE - C DESIGN page 52 | |  | Q DRAIN page 79 | |
| |  | CERFIX® PRONIVEL M page 41 | | | | |  | GLASS PROFILE page 82 | |
| |  | PROCORNER M page 42 | | internal corners profiles |  | | CERFIX® PROROUND M page 56 |  | WPSTOP page 90 |
| |  | PROCORNER P page 44 | | |  | | CERFIX® PROROUND P page 59 |  | SANIBORD page 92 |
|  | PVC LINE 8610- 8611 page 45 |  | | | CERFIX® PROROUND M GIC/ page 60 | | | | |
|  | CERFIX® PROBORD page 46 |  | | | CERFIX® PROINT page 60-61 | | profiles for floors of same height |  | CERFIX® PROANGLE page 96 |
| | | | | | | | | | |



CERFIX®
PROANGLE B
page 97



CERFIX®
PROANGLE
FLEX
page 98



CERFIX®
PRODECOR DJ
page 99



CERFIX®
PRODECOR DJ
FLEX
page 99

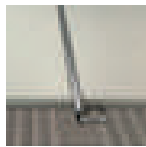

CERFIX®
PRODECOR
page 99



CERFIX®
PROSTYLE
page 100



PROJOINT U
page 101



PROJOINT
page 101



PROJOINT T
page 102



PROJOINT R
page 104



PROJOINT M
page 104



PROCLASSIC R
page 105



PROCLASSIC F
page 108

profiles for
floors of
different
height

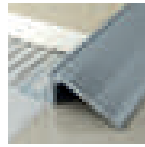

CERFIX®
PRONIVEL N
page 112



CERFIX®
PRONIVEL P
page 113



CERFIX®
PRONIVEL L
page 114



CERFIX®
PRONIVEL PB
page 114

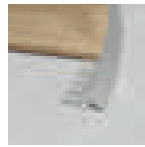

CERFIX®
PRONIVEL
FLEX
page 115



CERFIX®
PRONIVEL M
page 115



PROLEVEL
HIGH
page 116



PROLEVEL
MEDIUM
page 118



PROLEVEL
THIN
page 119

movement
joints



CERFIX®
PROJOINT
DIL NE
page 122



CERFIX®
PROJOINT
DIL NJ
page 122



CERFIX®
PROJOINT
DIL NL
page 123

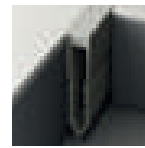

CERFIX®
PROJOINT
DIL NF
page 123



CERFIX®
PROJOINT DIL
NAN
page 124



CERFIX®
PROJOINT DIL
NPAN
page 124



CERFIX®
PROJOINT DIL
NIN
page 125



CERFIX®
PROJOINT DIL
NIL
page 125



CERFIX®
PROJOINT DIL
NTA - NTI - NTO
page 126



CERFIX®
PROJOINT DIL
STA - STI
page 126



CERFIX®
PROJOINT DIL
NZA
page 127



CERFIX®
PROJOINT DIL
NZS
page 127

Index



CERFIX®
PROJOINT DIL
PBE
page 128



CERFIX®
PROJOINT DIL
PBH
page 129



CERFIX®
PROJOINT DIL
PAS
page 129



CERFIX®
PROJOINT DIL
PHDE
page 130



CERFIX®
PROJOINT DIL
PFFE
page 130



CERFIX®
PROCOVER
FLEX
page 131

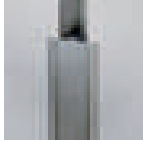

CERFIX®
PROCOVER FIX
page 131



CERFIX®
PROCOVER
page 132

profiles for balconies and terraces



CERFIX®
PROTEC CPCV
- CPCI
page 140



CERFIX®
PROTEC CPCVF
page 140



CERFIX®
PROTEC
CPCV/30/
page 142



CERFIX®
PROTEC CPNV
page 143



CERFIX®
PROTEC CPNVF
page 143



CERFIX®
PROTEC CPGV
page 144



CERFIX®
PROTEC CPQV
page 145



CERFIX®
PROTEC CPEV
- CPEI
page 146



CERFIX®
PROTEC CPHA
- CPHV
page 148

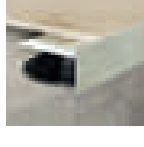

CERFIX®
PROTEC CPLB
- CPLV
page 149



CERFIX®
PROSTEP SMA
- SM
page 152



CERFIX®
PROTRIM IP
page 153



CERFIX®
PROSTEP SNG
- SN
page 153



CERFIX®
PROSTEP SAR
- SIR
page 154

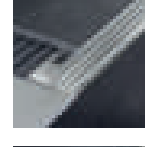

CERFIX®
PROSTEP SIS
page 155



CERFIX®
PROSTEP SIX
page 155



CERFIX®
PROSTEP
WOOD
page 156



CERFIX®
PROSTEP SP
page 156



CERFIX®
PROSTEP SA
- SB
page 157

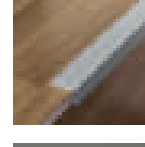

PROTECT
page 158

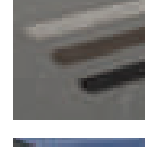

SAFETY-STEP
page 166

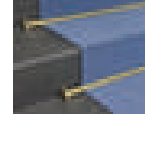

PROSTAIR
page 168

waterproofing, drainage, uncoupling



WPSTOP
page 136



WPSTOP 3
page 137

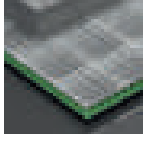

WPSTOP
DRAIN 10
page 137

stair nosing profiles



CERFIX®
PROSTEP SGA -
SGI - SGN - SGK
page 152

profiles for
wooden,
laminate
and LVT
floors

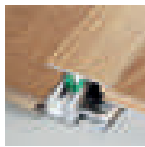

UNISYSTEM
PLUS
page 174



PROFIXTHIN
page 180



PRESTWOOD
page 182



RC
page 185



TERMINAL
FLEX
page 185



ALFIX 616
page 186



ALFIX 46
page 187

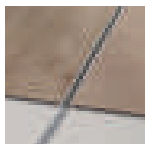

CERFIX®
PROJOINT DIL
page 188



CERFIX®
PRONIVEL PB
page 188-189



CERFIX®
PROJOINT T
page 189



CERFIX®
PROSTEP
page 190



PROTECT
page 190



CERFIX®
PROTRIM
page 191



CERFIX®
PROANGLE
page 191



CERFIX®
PROANGLE Q
page 191



CERFIX®
PROROUND M
page 192



CERFIX®
PROINT
page 192

metal line

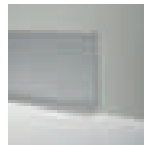

METAL LINE 90
page 198



METAL LINE 90
TREND COLOR
page 198



METAL LINE
790
page 200



METAL LINE 92
page 201



METAL LINE 93
page 201



METAL LINE 89
page 202



METAL LINE 89
TREND COLOR
page 202



METAL LINE 89
I DESIGN
page 203



PROLIGHT
METAL LINE 89
page 203



METAL LINE
89/613
page 204



METAL LINE
105
page 205

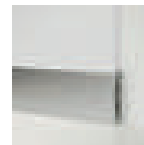

METAL LINE
87 - 88
page 206

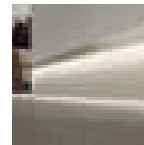

PROLIGHT
METAL LINE S
SKL/2
page 207



METAL LINE AF
- M DESIGN
page 207



METAL LINE
100
page 208

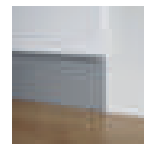

METAL LINE
101
page 208

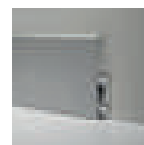

METAL LINE 95
page 209



METAL LINE 98
page 210

Index



METALLINE
97/4
page 211



METALLINE
97/7
page 212

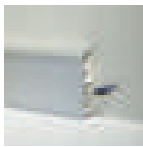

METALLINE
97/8
page 213

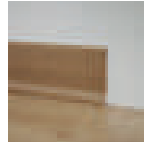

PVC LINE 8600
page 221



PVC LINE 8181
page 221

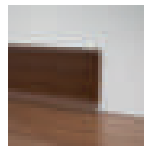

PVC LINE 8596
- 8598
page 222

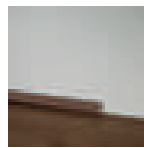

PVC LINE 8580
- 8582
page 222

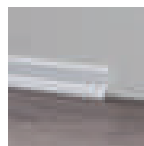

PVC LINE 8602
page 223

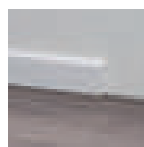

PVC LINE 8603
page 224



PVC LINE 8607
page 225



PVC LINE 148 -
172 - 173
page 226



PVC LINE 170 -
169 - 171
page 227

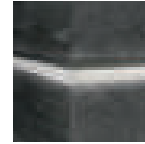

PROLIGHT
PROLIST Q LQL
page 232

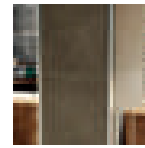

PROLIGHT
PROANGLE Q
ZQAL
page 233



PROLIGHT
PROTECT
SGA/11L
page 234



PROLIGHT
PROTECT G/9/F
page 234



PROLIGHT
PROTECT
126/L/F
page 235

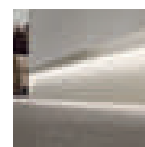

PROLIGHT
METAL LINE S
SKL/2
page 236



PROLIGHT
METAL LINE
87/88
page 237



PROLIGHT
METAL LINE 89
page 238



COMPONENTI
ELETTRICI
page 240

pvc line



PVC LINE 8605
page 216

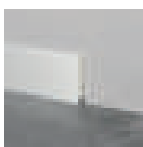

PVC LINE 8606
page 216

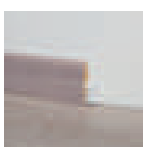

PVC LINE 8608
page 217

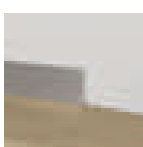

PVC LINE 8615
page 218

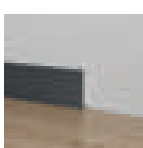

PVC LINE 8616
page 218

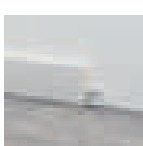

PVC LINE 8613
page 219

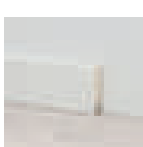

PVC LINE 8612
page 220

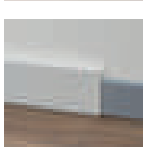

PVC LINE 8614
page 220

prolight

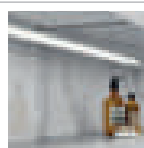

PROLIGHT
PROLIST LLA
- LLB
page 230



PROLIGHT
PROLIST TLA
- CLA
page 231



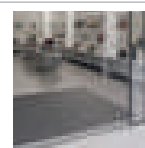



**technical
entrance
mats**



PROMAT
page 245

| | | | | |
|------------------------------|---|---|---|--|
| supports for raised floors |  | PP LEVEL DUO® COMPLETE SUPPORT page 249 |  | FIVE page 264 |
| |  | PP LEVEL DUO® MODULAR SUPPORT page 250 |  | SPACERS WEDGES page 265 |
| |  | PP LEVEL DUO® DOUBLE JOIST SYSTEM page 253 |  | ACCESSORIES FOR INSTALLATION page 266 |
| |  | PP LEVEL FIX COMPLETE SUPPORT page 254 |  | PROFLEX MACHINE page 267 |
| |  | PP LEVEL MINI page 255 | | |
| |  | SP1 page 255 | | |
| |  | PP LEVEL - ACCESSORIES page 256 | | |
| |  | CERFIX® PROTEC CPLB - CPLV page 257 | | |
| accessories for installation |  | PROTILER page 261 | | |
| |  | FIX LEVEL page 262 | | |
| |  | KLIC LEVEL page 263 | | |
| | | DIY profiles |  | DIY PROFILES page 270 |
| | | merchandising for the point of sale |  | MERCHANDISING FORTHEPOINT OFSALE page 278 |
| | | index by item | | page |

stainless steel

-  **SS**
polished stainless steel
AISI 304 DIN 1.4301
-  **SS3**
polished stainless steel
AISI 316 DIN 1.4404
-  **SS0**
polished stainless steel
AISI 430 DIN 1.4016
-  **SSP**
superpolished stainless steel
AISI 304 DIN 1.4301
-  **SSS**
satin stainless steel
AISI 304 DIN 1.4301
-  **SSB**
sandblasted stainless steel
AISI 304 DIN 1.4301
-  satin stainless steel
AISI 430 - DIN 1.4016













brass

-  **BN**
natural
-  **BP**
polished
-  **BCP**
plated polished
-  **BCG**
24kt gold plated

aluminium

-  **AN**
natural

anodised aluminium

-  **AS**
silver
-  **AG**
gold
-  **ASG**
sand gold
-  **AT**
titanium
-  **AB**
bronze
-  **ABE**
bronze elox
-  **ABL**
black
-  platinum
-  titanium
-  brown
-  dark brown
-  carbon

bright polished aluminium

-  **ABPS**
silver

-  **ABPG**
gold

-  **ABPT**
titanium

-  **ABPC**
copper

bright satin aluminium

-  **ABSS**
silver

-  **ABSG**
gold

-  **ABST**
titanium

-  **ABSG**
copper

-  **ABSB**
black

bright scratched aluminium

-  **ABBS**
silver

colour-coated aluminium

-  **AC RAL 9003**
matt white

-  **AC RAL 9003**
white

-  **AC RAL 9010**
matt white

-  **AC RAL 9010**
polished white

-  **AC RAL 8019**
dark brown

-  **AC RAL 7038**
ash grey

-  **AC RAL 7038**
ash grey embossed

-  **AC RAL 9006**
metal grey

-  **AC RAL 9007**
aluminium grey

-  **AC anthracite grey**

-  **AC rust**

-  **AC ancient grey**

-  **AC beige**

-  **AC sand**

-  **AC greige**

-  **AC stone**

-  **AC grey**

-  **AC bronze**

-  **AC dark brown**

-  **AC white ST**

-  **AC black ST**

-  **AC concrete white**

-  **AC concrete graphite**

-  **AC concrete smoke**

-  **AC concrete mud**

-  **AC concrete sand**

-  **AC metal dark**

-  **AC metal light**

-  **AC solid white**

decors Alcom® Plus

-  02

-  05

-  08

-  10

-  11

-  12

-  13

-  14

-  18

-  19

-  20

-  25

-  26

-  31

-  32

-  34

-  35

-  36

-  37

-  38

-  39

-  40

-  41

-  42

-  43

-  44

-  47

-  65

-  71

-  72

-  73

-  74

-  76

-  77

-  78

-  79

-  80

-  81

-  89

-  91

-  92

-  93

-  94

-  95

-  351

-  363

-  372

-  490

| | |
|--|------|
| | 560 |
| | 580 |
| | 590 |
| | 665 |
| | 670 |
| | 951 |
| | 975 |
| | 1003 |
| | 1006 |
| | 1009 |
| | 1012 |
| | 1021 |
| | 1024 |
| | 1030 |
| | 1033 |
| | 1036 |
| | 1042 |
| | 1045 |
| | 1051 |
| | 1054 |
| | 1057 |
| | 1060 |
| | 1063 |
| | 1066 |
| | 1069 |
| | 1081 |
| | 1084 |
| | 1090 |
| | 1093 |
| | 1096 |

| | |
|-------------------|---------------------------------|
| | 1099 |
| | 1102 |
| | 1105 |
| | 1108 |
| | 1111 |
| | 1202 |
| | 1203 |
| | 1204 |
| | 1205 |
| | 1206 |
| | 1207 |
| | 1208 |
| | 1209 |
| | 1210 |
| | 1211 |
| | 1212 |
| | 1213 |
| | 1214 |
| | 1215 |
| | 1216 |
| | 1217 |
| | 96 - embossed white RAL 9010 |
| | 97 - embossed black RAL 9005 |
| | 99 - satin silver |
| | 100 - satin steel |
| solid wood | |
| | natural oak |
| PVC | |
| | code 400 snow white |
| | code 402 white |

| | |
|-----------------|-----------------------------------|
| | code 404 9001 cream white |
| | code 406 RAL 1015 - ivory |
| | code 408 RAL 1019 - beige grey |
| | code 410 RAL 7030 - stone grey |
| | code 412 RAL 7038 - ash grey |
| | code 414 RAL 7035 - light grey |
| | code 416 anthracite |
| | code 418 blue |
| | code 420 pastel blue |
| | code 422 light green |
| | code 424 RAL 3002 - red |
| | code 426 RAL 9005 - black |
| | code 428 RAL 1023 - yellow |
| | code 430 pastel pink |
| | code 432 beige bahama |
| | code 434 peach |
| | code 436 caramel |
| | code 438 brown |
| | code 440 dark brown |
| | code 442 coral red |
| | code 444 raw sienna |
| | code 446 terracotta |
| foam PVC | |
| | decor 518 |
| | decor 520 |
| | decor 524 |
| | decor 525 |
| | decor 528 |
| | decor 530 |
| | decor 531 |

| | |
|--|----------------------|
| | decor 532 |
| | decor 533 |
| | decor 534 |
| | decor 536 |
| | decor 540 |
| | decor 542 |
| | decor 544 |
| | decor 545 |
| | decor 555 white |
| | decor 556 light grey |
| | decor 557 black |
| | decor 558 anthracite |
| | decor 559 grey |
| | decor 561 yellow |
| | decor 562 green |
| | decor 563 light blue |
| | decor 564 red |





external corners profiles

A line dedicated to the protection and finishing of outside corners of the wall tiles. Profiles are suitable for any type of environment for the variety of finishes available, matching perfectly with all types of ceramics and giving character to the compositions and linearity.

Proangle Q in aluminium is a line of universal profiles with square shape, specially designed to edge and protect the external corners of ceramic coverings, that can be also used for finishing worktops and platforms. ZQVNH/ boasts the certified antibacterial technology (according to the internationally recognized laboratory test JIS Z 2801:2000) which reduces the presence of the most dangerous bacteria up to 99%, thus assuring the best hygiene over time.

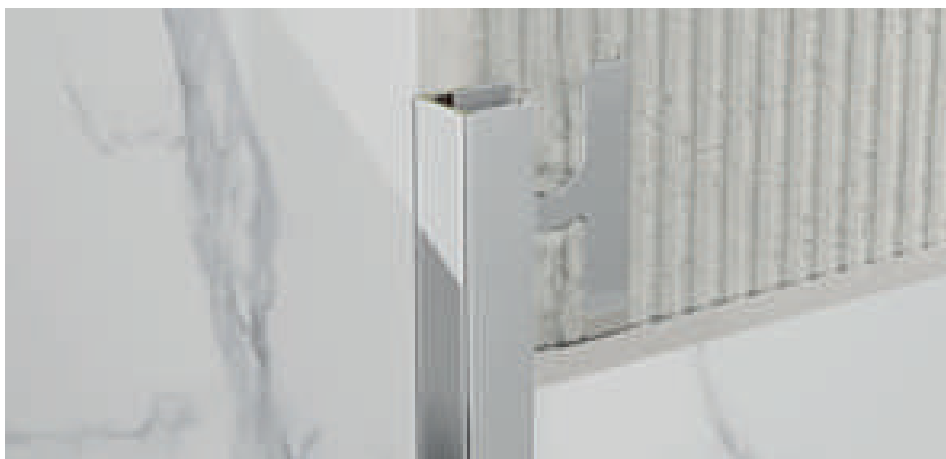

ZQBN/10 bright polished silver aluminium

PROANGLE Q

length = 270 cm - pack 20 pcs

| ART. | finishing | | 4,5 | 6 | 8 | 9 | 10 | 11 | 12,5 |
|--|-----------------------------------|-------------|--------------|-------------|--------------|-------------|--------------|--------------|--------------|
| ALUMINIUM | | | | | | | | | |
| ZQAN/ | silver anodised | | 88772 | 88875 | 88876 | 88877 | 88878 | 88879 | 88880 |
| | <i>euro/m</i> | | 4,53 | 4,53 | 4,53 | 4,73 | 4,89 | 5,25 | 5,57 |
| ZQAN/ | titanium anodised | | 88902 | 88903 | 88904 | 88905 | 88906 | 88907 | 88908 |
| | <i>euro/m</i> | | 5,16 | 5,16 | 5,16 | 5,36 | 5,52 | 5,88 | 6,20 |
| ZQAN/ | black anodised | | - | - | 89205 | - | 89206 | 89207 | 89208 |
| | <i>euro/m</i> | | - | - | 8,39 | - | 8,58 | 8,94 | 9,24 |
| ZQBN/ | bright polished silver | | 88816 | 88919 | 88920 | 88921 | 88922 | 88923 | 88924 |
| | <i>euro/m</i> | | 7,54 | 7,54 | 7,54 | 7,93 | 8,33 | 8,85 | 9,38 |
| ZQBN/ | bright polished gold | | 88933 | - | 88935 | - | 88937 | - | 88939 |
| ZQTN/ | bright polished titanium | | 88949 | 88950 | 88951 | 88952 | 88953 | 88954 | 88955 |
| ZQBRN/ | bright polished copper | | - | - | - | - | 88969 | - | 88971 |
| | <i>euro/m</i> | | 7,93 | 7,93 | 7,93 | 8,35 | 8,75 | 9,31 | 9,86 |
| ZQBSN/ | bright satin silver | | 88981 | 88982 | 88983 | - | 88985 | 88986 | 88987 |
| | bright satin gold | | 88997 | - | 88999 | - | 89001 | - | 89003 |
| ZQTMN/ | bright satin titanium | | 89013 | 89014 | 89015 | - | 89017 | - | 89019 |
| ZQBRSN/ | bright satin copper | | - | - | 89031 | - | 89033 | - | 89035 |
| | <i>euro/m</i> | | 8,78 | 8,78 | 8,78 | - | 9,57 | 10,31 | 10,66 |
| ZQBSN/ | bright satin black | | - | - | - | - | 89209 | 89210 | 89211 |
| | <i>euro/m</i> | | - | - | - | - | 11,97 | 12,73 | 13,09 |
| ZQAGN/ | bright scratched silver | | 89061 | - | 89063 | - | 89065 | - | 89067 |
| | <i>euro/m</i> | | 12,02 | - | 12,02 | - | 12,82 | - | 13,62 |
| COLOUR-COATED ALUMINIUM | | | | | | | | | |
| ZQVN/ | colour-coated matt white RAL 9003 | | - | - | 89200 | - | 89202 | 89203 | 89204 |
| | colour-coated white RAL 9003 | | 89077 | 89076 | 89079 | - | 89081 | 89078 | 89083 |
| <i>euro/m</i> | | 5,68 | 5,68 | 5,68 | - | 6,18 | 6,46 | 6,68 | |
| ANTIBACTERIAL COLOUR-COATED ALUMINIUM | | | | | | | | | |
| ZQVNH/ | colour-coated white RAL 9003 | | - | - | 89080 | - | 89082 | - | 89084 |
| | <i>euro/m</i> | | - | - | 7,41 | - | 7,97 | - | 8,47 |

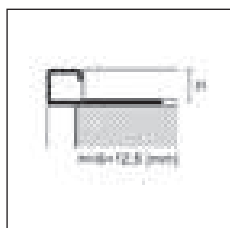
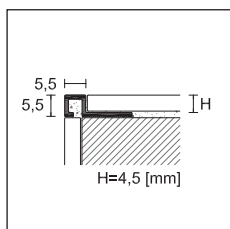

ZQAN/10 black anodised aluminium















Complete the article code with H measure (for example ZQAN/ for H=8 becomes ZQAN/8)

Items ZQVN available in different colours on demand minimum quantity 540 meters for colour

For a single piece, see sales conditions on page 288



PROANGLE Q - OUTSIDE / INSIDE CORNERS / END CAPS

| pack 5 pcs* | | H | | | | | | | |
|------------------|-----------------------------------|--|-------------|-------------|-------------|-------------|-------------|-------------|-------------|
| ART. | finishing | 4,5 | 6 | 8 | 9 | 10 | 11 | 12,5 | |
| ALUMINIUM | | | | | | | | | |
| ZQAN/ /EI | silver anodised |  | 88809 | 88882 | 88883 | 88884 | 88885 | 88886 | 88887 |
| | titanium anodised |  | 88910 | 88911 | 88912 | 88913 | 88914 | 88915 | 88916 |
| | <i>euro/pc</i> | | 4,98 | 4,98 | 4,98 | 4,98 | 4,98 | 4,98 | 4,98 |
| ZQAN/ /EI | black anodised |  | - | - | 89223 | - | 89224 | 89225 | 89226 |
| | <i>euro/pc</i> | | - | - | 5,93 | - | 5,93 | 5,93 | 5,93 |
| ZQBN/ /EI | bright polished silver |  | 88829 | 88926 | 88927 | 88928 | 88929 | 88930 | 88931 |
| | bright polished gold |  | 88941 | - | 88943 | - | 88945 | - | 88947 |
| | colour-coated matt white RAL 9003 |  | - | - | 89192 | - | 89194 | 89195 | 89196 |
| ZQVN/ /EI | colour-coated white RAL 9003 |  | 89085 | 89086 | 89087 | - | 89089 | 89088 | 89091 |
| | <i>euro/pc</i> | | 4,98 | 4,98 | 4,98 | 4,98 | 4,98 | 4,98 | 4,98 |
| ZQTN/ /EI | bright polished titanium |  | 88957 | 88958 | 88959 | 88960 | 88961 | 88962 | 88963 |
| ZQBRN/ /EI | bright polished copper |  | - | - | - | - | 88977 | - | 88979 |
| ZQBSN/ /EI | bright satin silver |  | 88989 | 88990 | 88991 | - | 88993 | 88994 | 88995 |
| | bright satin gold |  | 89005 | - | 89007 | - | 89009 | - | 89011 |
| ZQTMN/ /EI | bright satin titanium |  | 89021 | 89022 | 89023 | - | 89025 | - | 89027 |
| ZQBRSN/ /EI | bright satin copper |  | - | - | 89039 | - | 89041 | - | 89043 |
| ZQBSN/ /EI | bright satin black |  | - | - | - | - | 89227 | 89228 | 89229 |
| | <i>euro/pc</i> | | 5,93 | 5,93 | 5,93 | 5,93 | 5,93 | 5,93 | 5,93 |
| ZQAGN/ /EI | bright scratched silver |  | 89069 | - | 89071 | - | 89073 | - | 89075 |
| | <i>euro/pc</i> | | 7,90 | - | 7,90 | - | 7,90 | - | 7,90 |

no partial packaging



ZQAN/10 + ZQAN/10/EI silver anodised aluminium

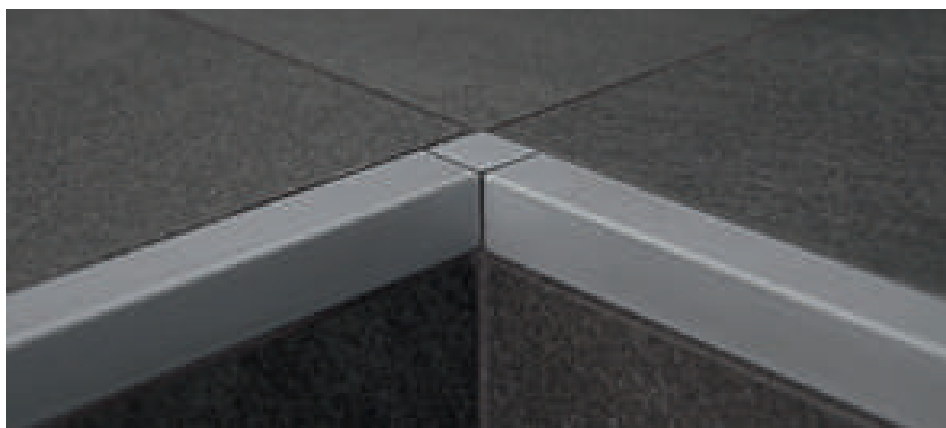

ZQAN/10 + ZQAN/10/EI silver anodised aluminium

Complete the article code with H measure (for example ZQAN/ /EI for H=8 becomes ZQAN/8/EI)

* available upon request pack of 1 pc in blister + 1,47 Euro (for example ZQAN/8/EI code 88883 becomes code 88883/B)

For a single piece, see sales conditions on page 288

cerfix® proangle Q

Colour-coated aluminium Trend Color Stone: modern finishes with neutral but warm and soft shades which reproduce the heterogeneity of stone thanks to a rough texture.

Colour-coated aluminium Trend Color Concrete: six original cement-effect finishes that recall the typical metropolis colours by revisiting them from a more refined point of view.

Colour-coated aluminium Trend Color Metal: two special metal tonalities which reproduce the iridescent nature of metals.



ZQVN/10 stone colour-coated aluminium

NEW PROANGLE Q - TREND COLOR

length = 270 cm - pack 20 pcs

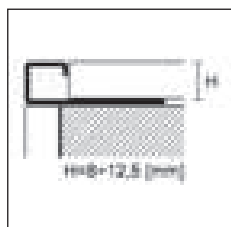

ZQVN/

TREND
COLOR

| ART. | finishing | H | | | | |
|--------------------------------|-------------------|---|-------------|-------------|-------------|-------------|
| | | 8 | 10 | 11 | 12,5 | |
| COLOUR-COATED ALUMINIUM | | | | | | |
| TREND COLOR STONE | | | | | | |
| | dark brown | | 89360 | 89310 | 89311 | 89312 |
| | anthracite grey | | 89093 | 89095 | 89106 | 89097 |
| | ancient grey | | 89362 | 89220 | 89221 | 89222 |
| | grey | | 89363 | 89290 | 89291 | 89292 |
| | rust | | 89094 | 89096 | 89107 | 89098 |
| | bronze | | 89365 | 89300 | 89301 | 89302 |
| | stone | | 89366 | 89280 | 89281 | 89282 |
| | greige | | 89367 | 89270 | 89271 | 89272 |
| | sand | | 89368 | 89260 | 89261 | 89262 |
| | beige | | 89369 | 89250 | 89251 | 89252 |
| ZQVN/ | white stone | | 89370 | 89320 | 89321 | 89322 |
| | black stone | | 89371 | 89330 | 89331 | 89332 |
| TREND COLOR CONCRETE | | | | | | |
| | concrete white | | - | 89131 | 89161 | 89181 |
| | concrete graphite | | - | 89132 | 89162 | 89182 |
| | concrete smoke | | - | 89133 | 89163 | 89183 |
| | concrete mud | | - | 89134 | 89164 | 89184 |
| | concrete sand | | - | 89135 | 89165 | 89185 |
| | solid white | | - | 89138 | 89168 | 89188 |
| TREND COLOR METAL | | | | | | |
| | metal dark | | - | 89136 | 89166 | 89186 |
| | metal light | | - | 89137 | 89167 | 89187 |
| | euro/m | | 7,58 | 7,76 | 8,07 | 8,24 |

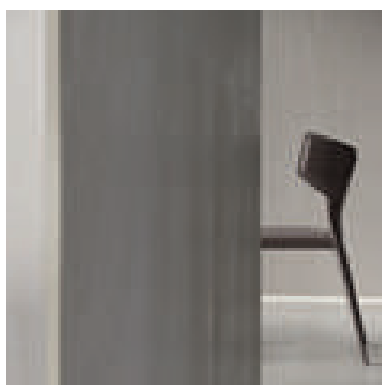

ZQVN/10 concrete white colour-coated aluminium

individually packed - Other heights with TREND COLOR finishes are available upon request, with a minimum of 540 meters.

Complete the article code with H measure (for example ZQVN/ for H=10 becomes ZQVN/10).

For a single piece, see sales conditions on page 288



ZQVN/ /EI
sand colour-coated
aluminium

NEW PROANGLE Q - TREND COLOR - OUTSIDE / INSIDE CORNERS / END CAPS

| pack 5 pcs* | | H | | | |
|--------------------------------|-------------------|-------------|-------------|-------------|-------------|
| ART. | finishing | 8 | 10 | 11 | 12,5 |
| COLOUR-COATED ALUMINIUM | | | | | |
| TREND COLOR STONE | | | | | |
| | dark brown | 89380 | 89303 | 89304 | 89305 |
| | anthracite grey | 89100 | 89102 | 89108 | 89104 |
| | ancient grey | 89382 | 89213 | 89214 | 89215 |
| | grey | 89383 | 89283 | 89284 | 89285 |
| | rust | 89101 | 89103 | 89109 | 89105 |
| | bronze | 89385 | 89293 | 89294 | 89295 |
| | stone | 89386 | 89273 | 89274 | 89275 |
| | greige | 89387 | 89263 | 89264 | 89265 |
| | sand | 89388 | 89253 | 89254 | 89255 |
| | beige | 89389 | 89243 | 89244 | 89245 |
| ZQVN/ /EI | white stone | 89390 | 89340 | 89341 | 89342 |
| | black stone | 89391 | 89350 | 89351 | 89352 |
| TREND COLOR CONCRETE | | | | | |
| | concrete white | - | 89392 | 89402 | 89410 |
| | concrete graphite | - | 89394 | 89403 | 89411 |
| | concrete smoke | - | 89395 | 89404 | 89412 |
| | concrete mud | - | 89396 | 89405 | 89413 |
| | concrete sand | - | 89397 | 89406 | 89414 |
| | solid white | - | 89400 | 89409 | 89417 |
| TREND COLOR METAL | | | | | |
| | metal dark | - | 89398 | 89407 | 89415 |
| | metal light | - | 89399 | 89408 | 89416 |
| | <i>euro/pc</i> | 6,10 | 6,10 | 6,10 | 6,10 |

no partial packaging

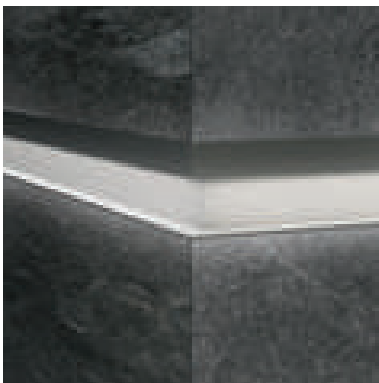

LED-light profiles and skirting boards with Trend Color finishes on page 232 and 236.

Complete the article code with H measure (for example ZQVN/ /EI per H = 10 becomes ZQVN/10/EI).

* available upon request pack of 1 pc in blister + 1,47 Euro (for example ZQVN/10/EI code 89303 becomes 89303/B).



For a single piece, see sales conditions on page 288 ZQVN/10 Trend Color finishes

cerfix® proangle Q

In anodised aluminium, X Design is characterized by a special scratched finish and original colours that allow different chromatic combinations, created for interior designers and architects by following the latest trends of modern design.



ZQAND/10 brown anodised aluminium



PROANGLE Q - X DESIGN

length = 270 cm - pack 20 pcs

| | | H | | | |
|---------------------------|---------------|---|--------------|--------------|--------------|
| ART. | finishing | 8 | 10 | 12,5 | |
| ANODISED ALUMINIUM | | | | | |
| | platinum | | 31110 | 31112 | 31114 |
| | titanium | | 31120 | 31122 | 31124 |
| ZQAND/ | brown | | 31130 | 31132 | 31134 |
| | dark brown | | 31140 | 31142 | 31144 |
| | carbon | | 31150 | 31152 | 31154 |
| | euro/m | | 12,59 | 13,42 | 14,27 |

individually packed

PROANGLE Q - X DESIGN - OUTSIDE / INSIDE CORNERS / END CAPS

pack 5 pcs

| | | H | | | |
|---------------------------|----------------|---|--------------|--------------|--------------|
| ART. | finishing | 8 | 10 | 12,5 | |
| ANODISED ALUMINIUM | | | | | |
| | platinum | | 31160 | 31162 | 31164 |
| | titanium | | 31170 | 31172 | 31174 |
| ZQAND/ EI | brown | | 31180 | 31182 | 31184 |
| | dark brown | | 31190 | 31192 | 31194 |
| | carbon | | 31200 | 31202 | 31204 |
| | euro/pc | | 11,07 | 11,07 | 11,07 |

no partial packaging

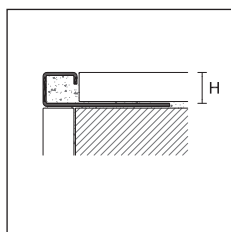

ZQAND/



Complete the article code with H measure (for example ZQAND/ for H=8 becomes ZQAND/8)

For a single piece, see sales conditions on page 288

Proangle Q in stainless steel is a line of universal profiles with square shape, specially designed to edge and protect the external corners of ceramic coverings.

They are also particularly suitable for the edging and the protection of floors and steps in different materials, such as ceramic, stone, wood and resins, and can be also used for finishing worktops and platforms.

Stainless steel makes the profile particularly resistant to chemical and atmospheric agents. The AISI 316 DIN 1.4404 quality offers superior resistance to corrosion and is therefore recommended for applications in areas subject to greater chemical stress, such as swimming pools and food industries, and coastal areas.



ZQINP/10 sandblasted stainless steel AISI 304-DIN 1.4301

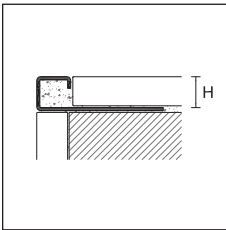

PROANGLE Q

length = 270 cm - pack 20 pcs

| ART. | finishing | | 6 | 8 | 9 | 10 | 11 | 12,5 | 15 |
|------------------------|--|--|-------|-------|-------|-------|-------|-------|-------|
| STAINLESS STEEL | | | | | | | | | |
| ZQIN/ | stainless steel AISI 304 - DIN 1.4301 | | 90049 | 90050 | 90051 | 90052 | 90053 | 90054 | 90055 |
| | euro/m | | 8,63 | 8,94 | 9,23 | 9,49 | 9,79 | 10,08 | 10,87 |
| ZQINS/ | satin stainless steel AISI 304 - DIN 1.4301 | | 90100 | 90101 | 90102 | 90103 | 90104 | 90105 | 90106 |
| ZQINP/ | sandblasted stainless steel AISI 304 - DIN 1.4301 | | 90130 | 90131 | 90132 | 90133 | 90134 | 90135 | 90136 |
| | euro/m | | 11,51 | 11,81 | 12,10 | 12,38 | 12,68 | 12,96 | 13,72 |
| ZQINX/ | stainless steel AISI 316 - DIN 1.4404 | | - | 90107 | - | 90109 | - | 90111 | - |
| | euro/m | | - | 12,34 | - | 13,52 | - | 14,71 | - |

individually packed - ZQIN/15, ZQINS/15 and ZQINP/15 packaging of 10 pcs

PROANGLE Q - OUTSIDE / INSIDE CORNERS / END CAPS

pack 5 pcs

| ART. | finishing | | 6 | 8 | 9 | 10 | 11 | 12,5 | 15 |
|------------------------|--|--|-------|-------|-------|-------|-------|-------|-------|
| STAINLESS STEEL | | | | | | | | | |
| ZQIN/ /EI | stainless steel AISI 304 - DIN 1.4301 | | 90064 | 90065 | 90066 | 90067 | 90068 | 90069 | 90070 |
| | euro/pc | | 12,83 | 12,83 | 12,83 | 12,83 | 12,83 | 12,83 | 12,83 |
| ZQINS/ /EI | satin stainless steel AISI 304 - DIN 1.4301 | | 90112 | 90113 | 90114 | 90115 | 90116 | 90117 | 90118 |
| ZQINP/ /EI | sandblasted stainless steel AISI 304 - DIN 1.4301 | | 90137 | 90138 | 90139 | 90140 | 90141 | 90142 | 90143 |
| | euro/pc | | 14,40 | 14,40 | 14,40 | 14,40 | 14,40 | 14,40 | 14,40 |
| ZQINX/ /EI | stainless steel AISI 316 - DIN 1.4404 | | - | 90119 | - | 90121 | - | 90123 | - |
| | euro/pc | | - | 15,79 | - | 15,79 | - | 15,79 | - |
| METAL | | | | | | | | | |
| ZQIM/ /EI | polished stainless steel | | - | 90092 | 90093 | 90094 | 90095 | 90096 | - |
| | euro/pc | | - | 3,56 | 3,56 | 3,56 | 3,56 | 3,56 | - |
| ZQIMS/ /EI | satin steel | | - | 90152 | 90153 | 90154 | 90155 | 90156 | - |
| | euro/pc | | - | 5,59 | 5,59 | 5,59 | 5,59 | 5,59 | - |
| ZQIMP/ /EI | sandblasted steel | | - | 90162 | 90163 | 90164 | 90165 | 90166 | - |
| | euro/pc | | - | 5,59 | 5,59 | 5,59 | 5,59 | 5,59 | - |

no partial packaging for ZQIM/ /EI, ZQIMS/ /EI and ZQIMP/ /EI



ZQIN/10/EI stainless steel AISI 304 - DIN 1.4301

Complete the article code with H measure (for example ZQIN/ for H=8 becomes ZQIN/8)
For a single piece, see sales conditions on page 288

cerfix® proangle Q

Proangle Q in polished brass is classic and modern at the same time and can be easily combined to handles, taps and other furniture accessories of the same material and finish.

The chromium-plated version stands out for its brilliance and is perfect as decorative element in spaces characterized by elegance and attention to details.

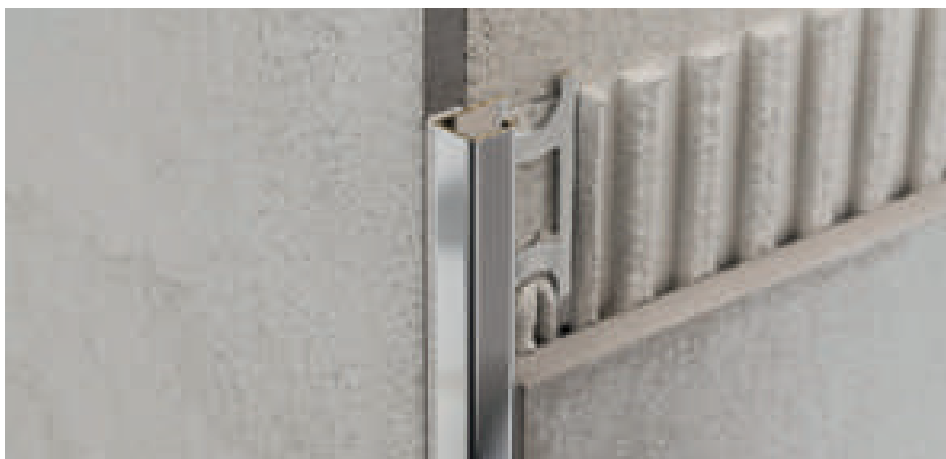

ZQKN/10 chromium-plated brass

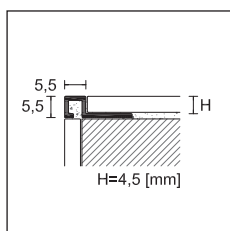

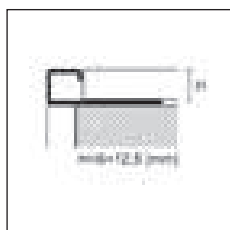

PPDESIGN



ZQKN/ EI
chromium-plated
brass

PROANGLE Q



length = 270 cm - pack 20 pcs

| | | H | | | | | |
|------------------------------|-----------------|---|-------|-------|-------|-------|-------|
| ART. | finishing | 4,5 | 8 | 10 | 11 | 12,5 | |
| POLISHED BRASS | | | | | | | |
| ZQLN/ | polished |  | 90022 | 90056 | 90057 | 90063 | 90058 |
| | euro/m | | 10,56 | 15,62 | 16,35 | 16,81 | 17,23 |
| CHROMIUM-PLATED BRASS | | | | | | | |
| ZQKN/ | chromium plated |  | 88870 | 90059 | 90060 | 90074 | 90061 |
| | euro/m | | 16,33 | 22,63 | 23,40 | 23,84 | 24,32 |

individually packed - ZQKN/12,5 packaging of 10 pcs

PROANGLE Q - OUTSIDE / INSIDE CORNERS / END CAPS

length = 270 cm - pack 5 pcs

| | | H | | | | | |
|--------------|-----------------|---|-------|-------|-------|-------|-------|
| ART. | finishing | 4,5 | 8 | 10 | 11 | 12,5 | |
| BRASS | | | | | | | |
| ZQLN/ EI | polished |  | 90062 | 90071 | 90072 | 90075 | 90073 |
| | euro/pc | | 12,83 | 12,83 | 12,83 | 12,83 | 12,83 |
| ZQKN/ EI | chromium plated |  | 88872 | 90077 | 90083 | 90085 | 90087 |
| | euro/pc | | 14,94 | 14,94 | 14,94 | 14,94 | 14,94 |

Complete the article code with H measure
(for example ZQLN/ for H=8 becomes ZQLN/8)

For a single piece, see sales conditions on page 288

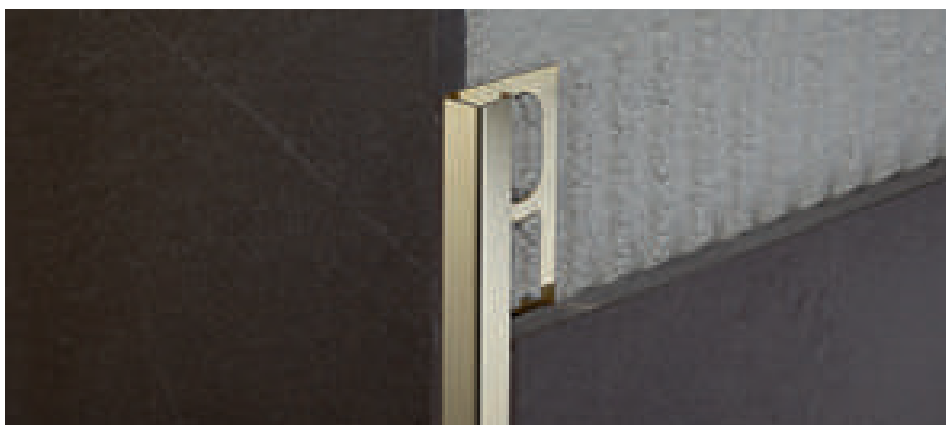

ZQLN/10 brass polished

Proangle Q in coextruded PVC is a line of universal profiles with square shape, specially designed to edge and protect the external corners of ceramic coverings. Thanks to the special section with soft PVC inserts, these profiles absorb the micro-movements that discharge on the corner due to the tension of the wall coverings.



ZQP/8 PVC white

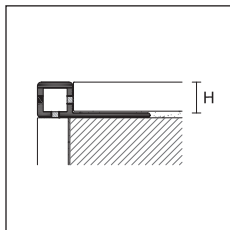



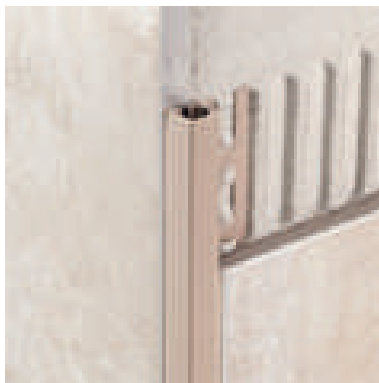





ZQP/



ZQP/8 PVC beige bahama

PROANGLE Q

length = 270 cm

| | | H | | | | |
|------------------------|----------------------|---|-------|-------|-------|-------|
| ART. | finishing | 6 | 8 | 10 | 12,5 | |
| CO-EXTRUDED PVC | | | | | | |
| | white |  | 80800 | 80801 | 80802 | 80803 |
| | cream white RAL 9001 |  | 80804 | 80805 | 80806 | 80807 |
| | ivory RAL 1015 |  | 80808 | 80809 | 80810 | 80811 |
| | beige grey RAL 1019 |  | 80812 | 80813 | 80814 | 80815 |
| ZQP/ | stone grey RAL 7030 |  | 80816 | 80817 | 80818 | 80819 |
| | light grey RAL 7035 |  | 80820 | 80821 | 80822 | 80823 |
| | anthracite |  | 80824 | 80825 | 80826 | 80827 |
| | beige bahama |  | 80832 | 80833 | 80834 | 80835 |
| | brown |  | 80836 | 80837 | 80838 | 80839 |

pack 20 pcs

euro/m

1,24

1,34

1,45

1,55

pack 80 pcs

euro/m

-

-

-

1,37

pack 100 pcs

euro/m

1,01

1,11

1,22









-

no partial packaging

to order the pack of 80 and 100 pcs, mark /80 or /100 after the article code (for example, code 80800 becomes 80800/100)

PROANGLE Q - OUTSIDE / INSIDE CORNERS / END CAPS

pack 12 pcs*

| | | H | | | | |
|----------------------|----------------------|---|-------|-------|-------|-------|
| ART. | finishing | 6 | 8 | 10 | 12,5 | |
| POLYPROPYLENE | | | | | | |
| | white |  | 80850 | 80851 | 80852 | 80853 |
| | cream white RAL 9001 |  | 80854 | 80855 | 80856 | 80857 |
| | ivory RAL 1015 |  | 80858 | 80859 | 80860 | 80861 |
| | beige grey RAL 1019 |  | 80862 | 80863 | 80864 | 80865 |
| ZQP/ | stone grey RAL 7030 |  | 80866 | 80867 | 80868 | 80869 |
| /EI | light grey RAL 7035 |  | 80870 | 80871 | 80872 | 80873 |
| | anthracite |  | 80874 | 80875 | 80876 | 80877 |
| | beige bahama |  | 80882 | 80883 | 80884 | 80885 |
| | brown |  | 80886 | 80887 | 80888 | 80889 |
| | euro/pc | | 0,97 | 0,97 | 0,97 | 0,97 |

no partial packaging - pack of 50 pcs Euro 0,74

to order the pack of 50 pcs, mark /50 after the article code (for example, code 80850 becomes 80850/50)

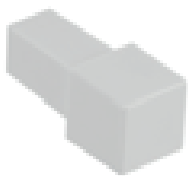

ZQP//EI
white polypropylene

Complete the article code with H measure (for example ZQP/ for H=8 becomes ZQP/8)

* available upon request pack of 1 pc in blister + 1,47 Euro (for example ZQP/8/EI code 80851 white becomes code 80851/B)

Colours available on demand - minimum quantity 2700 meters

For a single piece, see sales conditions on page 288

cerfix® proangle

Proangle in aluminium is a line of profiles for edging and protecting the external corners of ceramic coverings. Its L shape outlines clearly tile coverings, such as rectified porcelain stoneware.

Available in different colours and finishes, Proangle can also be used as decorative element, creating refined and pleasant combination/contrast effects with a wide variety of coverings.

ZQVNH/ boasts the certified antibacterial technology (according to the internationally recognized laboratory test JIS Z 2801:2000) which reduces the presence of the most dangerous bacteria up to 99%, thus assuring the best hygiene over time.



ZA/10 silver anodised aluminium

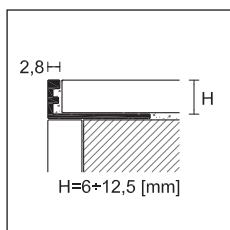
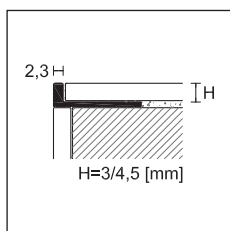

PROANGLE

length = 270 cm - pack 20 pcs

| | | H | | | | | | | | |
|--|-----------------------------------|---|-------|-------|-------|-------|-------|-------|-------|-------|
| ART. | finishing | 3 | 4,5 | 6 | 8 | 9 | 10 | 11 | 12,5 | |
| ALUMINIUM | | | | | | | | | | |
| ZA/ | silver anodised | | 90338 | 90340 | 88204 | 88205 | 88217 | 88206 | 88218 | 88207 |
| | <i>euro/m</i> | | 2,95 | 3,08 | 3,15 | 3,23 | 3,31 | 3,39 | 3,66 | 3,91 |
| ZA/ | titanium anodised | | - | - | 88253 | 88254 | - | 88255 | 88257 | 88256 |
| | <i>euro/m</i> | | - | - | 3,78 | 3,86 | - | 4,02 | 4,29 | 4,54 |
| ZA/ | black anodised | | - | - | - | 88265 | - | 88266 | 88267 | 88268 |
| | <i>euro/m</i> | | - | - | - | 4,62 | - | 4,80 | 4,94 | 5,19 |
| ZB/ | bright polished silver | | - | 88260 | 88294 | 88295 | - | 88296 | 88220 | 88297 |
| | <i>euro/m</i> | | - | 6,86 | 7,08 | 7,37 | - | 7,53 | 7,73 | 7,92 |
| ZB/ | bright polished gold | | - | 88261 | 88339 | 88340 | - | 88341 | - | 88342 |
| | bright polished titanium | | - | 90341 | 88344 | 88345 | - | 88346 | 88348 | 88347 |
| <i>euro/m</i> | | - | 7,06 | 7,30 | 7,59 | - | 7,75 | 7,96 | 8,16 | |
| ZBS/ | bright satin silver | | - | - | - | - | - | 88356 | 88357 | 88358 |
| ZTM/ | bright satin titanium | | - | - | - | - | - | 88359 | 88360 | 88361 |
| | <i>euro/m</i> | | - | - | - | - | - | 8,37 | 8,58 | 8,78 |
| ZBS/ | bright satin black | | - | - | - | - | - | 88353 | 88354 | 88355 |
| <i>euro/m</i> | | - | - | - | - | - | - | 8,75 | 8,96 | 9,18 |
| COLOUR-COATED ALUMINIUM | | | | | | | | | | |
| ZV/ | colour-coated matt white RAL 9003 | | - | - | - | 88395 | - | 88396 | 88435 | 88397 |
| | colour-coated white RAL 9003 | | - | - | 88384 | 88385 | - | 88386 | 88436 | 88387 |
| <i>euro/m</i> | | - | - | 4,03 | 4,17 | - | 4,54 | 4,67 | 4,82 | |
| ANTIBACTERIAL COLOUR-COATED ALUMINIUM | | | | | | | | | | |
| ZVH/ | colour-coated white RAL 9003 | | - | - | - | 88390 | - | 88392 | - | 88394 |
| <i>euro/m</i> | | - | - | - | 5,81 | - | 6,20 | - | 6,49 | |

individually packed

Complete the article code with H measure (for example ZA/ for H=8 becomes ZA/8)

Items ZV/ available in different colours on demand - minimum quantity 540 meters for colour.

Proangle: for different heights till 25 mm please see page 96-97

Items ZA-AI bendable version see page 98

For a single piece, see sales conditions on page 288

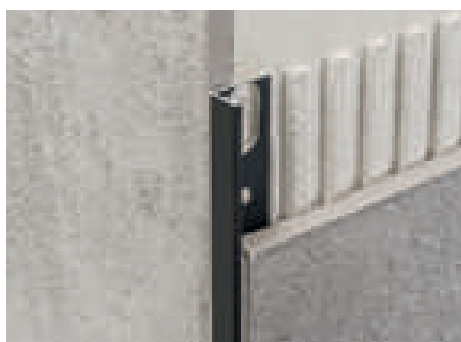

ZA/10 black anodised aluminium



ZA/10 titanium anodised aluminium

Colour-coated aluminium Trend Color Stone: modern finishes with neutral but warm and soft shades which reproduce the heterogeneity of stone thanks to a rough texture.

Colour-coated aluminium Trend Color Concrete: six original cement-effect finishes that recall the typical metropolis colours by revisiting them from a more refined point of view.

Colour-coated aluminium Trend Color Metal: two special metal tonalities which reproduce the iridescent nature of metals.



ZV/10 colour-coated aluminium beige

NEW PROANGLE - TREND COLOR

length = 270 cm - pack 20 pcs

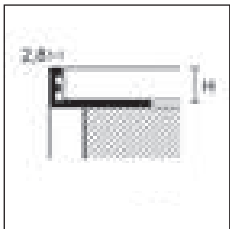

ZV/

TREND COLOR

| | | H | | |
|--------------------------------|-------------------|-------------|-------------|-------------|
| ART. | finishing | 8 | 10 | 11 |
| COLOUR-COATED ALUMINIUM | | | | |
| TREND COLOR STONE | | | | |
| | dark brown | 88446 | 88407 | 88417 |
| | anthracite grey | 88447 | 88398 | 88408 |
| | ancient grey | 88448 | 88400 | 88410 |
| | grey | 88449 | 88405 | 88415 |
| | rust | 88450 | 88399 | 88409 |
| | bronze | 88451 | 88406 | 88416 |
| | stone | 88452 | 88404 | 88414 |
| | greige | 88453 | 88403 | 88413 |
| | sand | 88454 | 88402 | 88412 |
| | beige | 88455 | 88401 | 88411 |
| | white stone | 88456 | 88428 | 88433 |
| ZV/ | black stone | 88457 | 88429 | 88434 |
| TREND COLOR CONCRETE | | | | |
| | concrete white | - | 88437 | 88461 |
| | concrete graphite | - | 88438 | 88462 |
| | concrete smoke | - | 88439 | 88463 |
| | concrete mud | - | 88440 | 88464 |
| | concrete sand | - | 88441 | 88465 |
| | solid white | - | 88460 | 88468 |
| TREND COLOR METAL | | | | |
| | metal dark | - | 88458 | 88466 |
| | metal light | - | 88459 | 88467 |
| | euro/m | 5,89 | 6,03 | 6,18 |



ZV/10 colour-coated aluminium white stone

individually packed - Other heights with TREND COLOR finishes are available upon request, with a minimum of 540 meters.

LED-light profiles and skirting boards with Trend Color finishes on page 232 and 236.

Complete the article code with H measure (for example ZV/ for H=10 becomes ZV/10).

For a single piece, see sales conditions on page 288

Proangle in stainless steel is a line of profiles for edging and protecting the external corners of ceramic coverings. Its L shape outlines clearly tile coverings, such as rectified porcelain stoneware.

Stainless steel makes the profile particularly resistant to chemical and atmospheric agents. The AISI 316 DIN 1.4404 quality offers superior resistance to corrosion and is therefore recommended for applications in areas subject to greater chemical stress, such as swimming pools and food industries, and coastal areas.



AI/10 stainless steel AISI 304 - DIN 1.4301

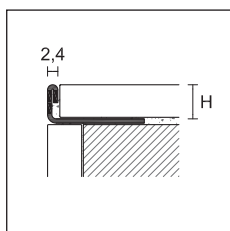

PROANGLE

length = 270 cm - pack 20 pcs

| | | H | | | | | | | | |
|------------------------|--|-------|-------|-------|-------|-------|-------|-------|-------|--|
| ART. | finishing | 3 | 4,5 | 6 | 8 | 9 | 10 | 11 | 12,5 | |
| STAINLESS STEEL | | | | | | | | | | |
| AI/ | stainless steel AISI 304 - DIN 1.4301 | 91636 | 91638 | 91642 | 91644 | 91645 | 91646 | 91647 | 91648 | |
| | euro/m | 6,98 | 7,11 | 7,44 | 7,69 | 7,89 | 8,05 | 8,23 | 8,37 | |
| AIL/ | superpolished stainless steel AISI 304 - DIN 1.4301 | - | 91690 | - | 91694 | - | 91696 | - | 91698 | |
| | euro/m | - | 9,12 | - | 10,10 | - | 10,45 | - | 10,84 | |
| AIS/ | satin stainless steel AISI 304 - DIN 1.4301 | - | 91671 | 91673 | 91674 | - | 91675 | 91677 | 91676 | |
| | euro/m | - | 8,89 | 9,23 | 9,48 | - | 9,83 | 9,99 | 10,16 | |
| AIP/ | sandblasted stainless steel AISI 304 - DIN 1.4301 | - | - | 91700 | 91702 | - | 91704 | 91705 | 91706 | |
| | euro/m | - | - | 10,75 | 10,99 | - | 11,37 | 11,52 | 11,68 | |
| AIX/ | stainless steel AISI 316 - DIN 1.4404 | - | - | 91684 | 91685 | - | 91686 | 91688 | 91687 | |
| | euro/m | - | - | 8,76 | 8,96 | - | 9,45 | 9,94 | 10,41 | |

individually packed

NEW PROANGLE - OUTSIDE CORNER

pack 5 pcs

| | | H | | | | | | | | |
|------------------------|--|---|-----|---|---|---|-------|-------|-------|--|
| ART. | finishing | 3 | 4,5 | 6 | 8 | 9 | 10 | 11 | 12,5 | |
| STAINLESS STEEL | | | | | | | | | | |
| AI//E | stainless steel AISI 304 - DIN 1.4301 | - | - | - | - | - | 91663 | 91664 | 91665 | |
| | euro/pc | - | - | - | - | - | 7,77 | 7,77 | 7,77 | |
| AIS//E | satin stainless steel AISI 304 - DIN 1.4301 | - | - | - | - | - | 91680 | 91681 | 91682 | |
| | euro/pc | - | - | - | - | - | 8,82 | 8,82 | 8,82 | |

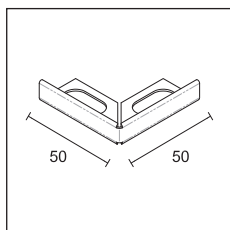

AI//E
AIS//E



AI//E stainless steel AISI 304 - DIN 1.4301

Complete the article code with H measure
(for example AI/ for H=10 becomes AI/10)

For a single piece, see sales conditions on page 288

cerfix® proangle-prodecor

Proangle ZK and Prodecor DJK are two L-shaped profiles in chromium-plated brass, with different section, designed for edging and protecting the external corners of ceramic coverings. Chromium-plated brass stands out for its brilliance and is perfect as decorative element in spaces characterized by elegance and attention to details.

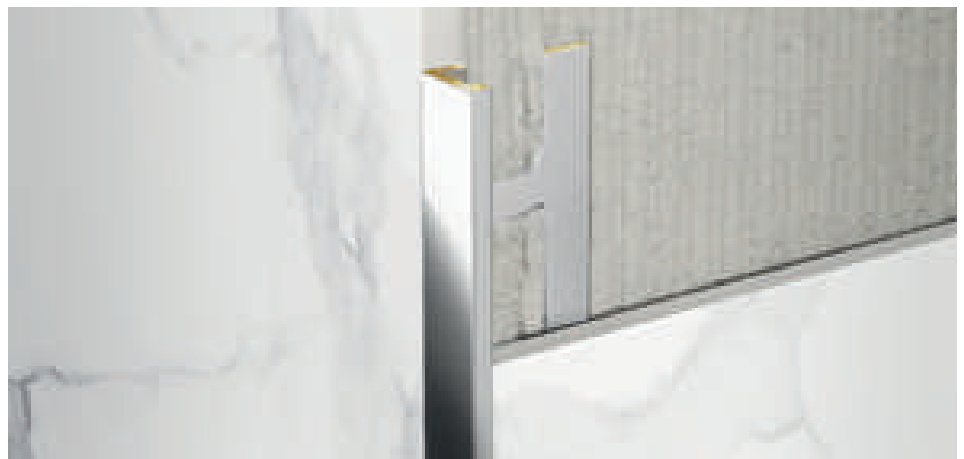

Proangle ZK/ chromium-plated brass

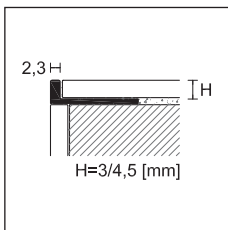

ZK/

PPDESIGN

PROANGLE

length = 270 cm - pack 20 pcs

| ART. | finishing | 4,5 | 6 | 8 | 9 | 10 | 11 | 12,5 |
|------------------------------|-----------------|-------|-------|-------|---|-------|-------|-------|
| CHROMIUM-PLATED BRASS | | | | | | | | |
| ZK/ | chromium plated | 90081 | 88114 | 88115 | - | 88116 | 88118 | 88117 |
| | euro/m | 16,93 | 17,05 | 17,63 | - | 18,02 | 18,29 | 18,67 |

individually packed

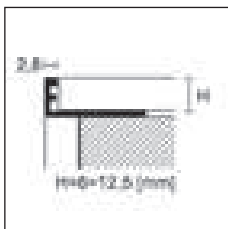

ZK/

PPDESIGN

PRODECOR DJ

length = 270 cm - pack 20 pcs

| ART. | finishing | 8 | 10 | 12,5 | 15 | 20 |
|------------------------------|-----------------|-------|-------|-------|-------|-------|
| CHROMIUM-PLATED BRASS | | | | | | |
| DJK/ | chromium plated | 95700 | 95702 | 95704 | 95703 | 95705 |
| | euro/m | 18,87 | 19,31 | 19,86 | 20,69 | 22,24 |

individually packed - art. DJK/20 pack 10 pcs

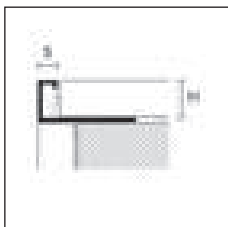

DJK/

PRODECOR DJ - OUTSIDE AND INSIDE CORNERS

pack 5 pcs

| ART. | finishing | 8 | 10 | 12,5 | 15 | 20 |
|------------------------------|-----------------|-------|-------|-------|-------|-------|
| CHROMIUM-PLATED BRASS | | | | | | |
| DJK/ /EI | chromium plated | 95706 | 95707 | 95708 | 95709 | 95710 |
| | euro/pc | 16,15 | 16,15 | 16,15 | 16,15 | 16,15 |

no partial packaging



DJK/ /EI



Prodecor DJK/ chromium-plated brass

Complete the article code with H measure (for example ZK/ for H=8 becomes ZK/8)

For a single piece, see sales conditions on page 288

Proangle in PVC is a line of profiles for edging and protecting the external corners of ceramic coverings. Its L shape outlines clearly tile coverings, such as rectified porcelain stoneware. Available in many different colours, they can be used in the most varied spaces.

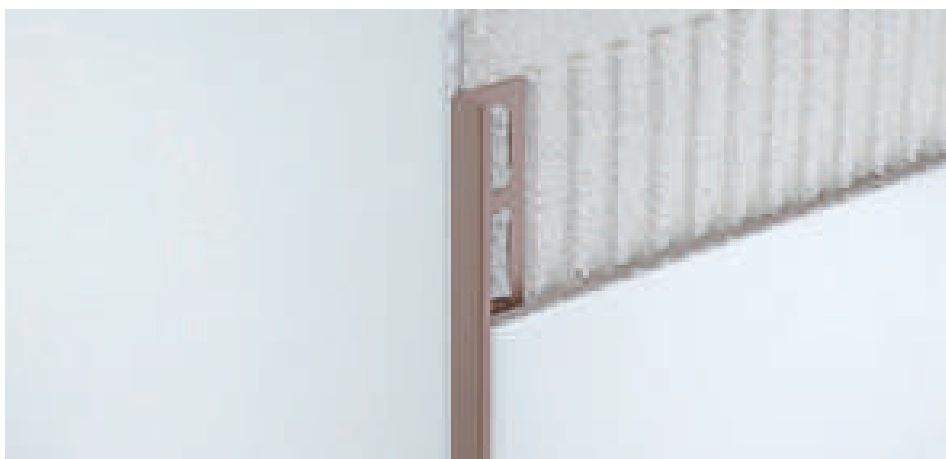

PV/8 PVC beige grey

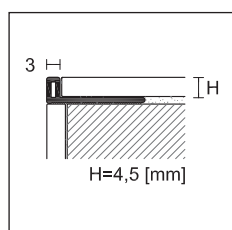



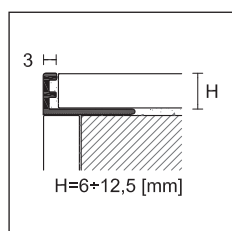









PV/



PV/

PROANGLE

length = 270 cm

| | | H | | | | | |
|---------------------|----------------------|---|-------------|-------------|-------------|-------------|-------------|
| ART. | finishing | 4,5 | 6 | 8 | 10 | 12,5 | |
| PVC | | | | | | | |
| | snow white |  | 80610 | 80496 | 80497 | 80498 | 80499 |
| | white |  | 80611 | 80500 | 80501 | 80502 | 80503 |
| | cream white RAL 9001 |  | - | 80504 | 80505 | 80506 | 80507 |
| | ivory RAL 1015 |  | - | 80508 | 80509 | 80510 | - |
| | beige grey RAL 1019 |  | - | 80512 | 80513 | 80514 | - |
| PV/ | beige bahama |  | - | 80552 | 80553 | 80554 | - |
| | stone grey RAL 7030 |  | - | 80516 | 80517 | 80518 | - |
| | ash grey RAL 7038 |  | - | 80520 | 80521 | 80522 | - |
| | light grey RAL 7035 |  | - | 80524 | 80525 | 80526 | 80527 |
| | anthracite |  | - | 80559 | 80560 | 80561 | - |
| | red RAL 3002 |  | - | 80528 | 80529 | 80530 | - |
| | black RAL 9005 |  | - | 80532 | 80533 | 80534 | - |
| pack 20 pcs | | | | | | | |
| | euro/m | | 1,14 | 1,19 | 1,28 | 1,39 | 1,49 |
| pack 100 pcs | | | | | | | |
| | euro/m | | 0,91 | 0,96 | 1,05 | 1,16 | 1,26 |

no partial packaging

to order the pack of 100 pcs, mark /100 after article code (for example code 80497 becomes 80497/100)

Complete the article code with H measure
(for example PV/ for H=8 becomes PV/8)

Items PV/ available in different colours on demand - minimum quantity 2700 meters for colour

For a single piece, see sales conditions on page 288

Protrim IP are minimalist profiles in aluminium or stainless steel, suitable for the edging of external corners that need the 45 degrees cut. These profiles allow a perfect installation both on wall coverings and on stairs or platforms in ceramic or wood.



IPA/11 silver anodised aluminium



IPI/11 stainless steel AISI 304 - DIN 1.4301

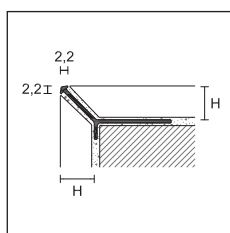

IPA/
IPB/
IPV/

PROTRIM IP

length = 270 cm - pack 20 pcs

| | | H | | | |
|------------------|------------------------|-------|-------|-------|-------|
| ART. | finishing | 4,5 | 8 | 11 | 15 |
| ALUMINIUM | | | | | |
| IPA/ | silver anodised | 95006 | 95178 | 95181 | 95185 |
| | euro/m | 4,17 | 4,28 | 4,28 | 4,50 |
| IPB/ | bright polished silver | 95008 | - | - | - |
| | euro/m | 7,02 | | | |

individually packed

TREND COLOR

PROTRIM IP - TREND COLOR STONE

length = 270 cm - pack 20 pcs

| | | H | | | |
|--------------------------------|-----------------|----|--|--|-------|
| ART. | finishing | 11 | | | |
| COLOUR-COATED ALUMINIUM | | | | | |
| TREND COLOR STONE | | | | | |
| | dark brown | | | | 95182 |
| | anthracite grey | | | | 95183 |
| | ancient grey | | | | 95184 |
| | grey | | | | 95186 |
| IPV/ | rust | | | | 95187 |
| | bronze | | | | 95188 |
| | stone | | | | 95189 |
| | greige | | | | 95190 |
| | sand | | | | 95191 |
| | beige | | | | 95192 |
| | white stone | | | | 95193 |
| | black stone | | | | 95194 |
| | euro/m | | | | 7,28 |

individually packed - Other heights with TREND COLOR finishes are available upon request, with a minimum of 540 meters.

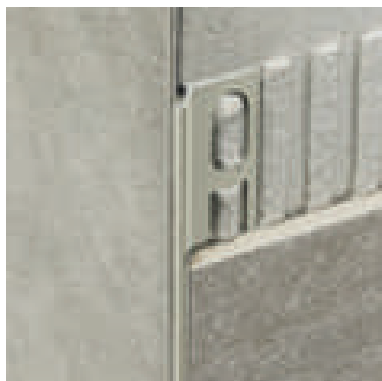

IPV/11 beige colour-coated aluminium

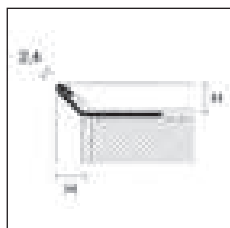

IPI/

PROTRIM IP

length = 270 cm - pack 20 pcs

| | | H | | | |
|------------------------|---------------------------------------|-------|-------|-------|-------|
| ART. | finishing | 7 | 8 | 11 | 12,5 |
| STAINLESS STEEL | | | | | |
| IPI/ | stainless steel AISI 304 - DIN 1.4301 | 95169 | 95170 | 95173 | 95174 |
| | euro/m | 8,45 | 8,73 | 9,24 | 9,63 |

individually packed

Complete the article code with H measure (es: IPA/ for H=10 becomes IPA/10)

For a single piece, see sales conditions on page 288

Protrim in aluminium is a line of profiles with rounded shape, specially designed to edge and protect the external corners of ceramic coverings. Their shape also acts as symmetric finishing and helps preventing accidents.

RVH/ boasts the certified antibacterial technology (according to the internationally recognized laboratory test JIS Z 2801:2000) which reduces the presence of the most dangerous bacteria up to 99%, thus assuring the best hygiene over time.



RA/10 silver anodised aluminium

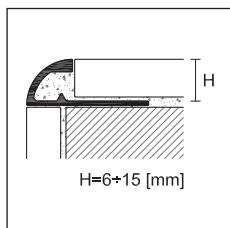
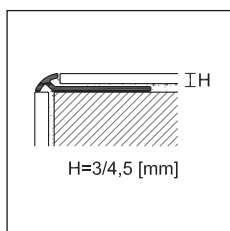

PROTRIM

length = 270 cm - pack 20 pcs

| | | H | | | | | | | | |
|--|--------------------------|-------------|-------------|-------------|-------------|-------------|--------------|--------------|-------------|--|
| ART. | finishing | 3 | 4,5 | 6 | 8 | 10 | 11 | 12,5 | 15 | |
| ALUMINIUM | | | | | | | | | | |
| RA/ | silver anodised | 92055 | 92056 | 92070 | 92072 | 92074 | 92060 | 92076 | 92078 | |
| | gold anodised | 92025 | 92026 | 92040 | 92042 | 92044 | - | 92046 | - | |
| | euro/m | 3,77 | 3,98 | 4,34 | 4,53 | 4,89 | 5,26 | 5,57 | 6,21 | |
| RB/ | titanium anodised | 92085 | 92086 | 92087 | 92090 | 92094 | - | 92096 | - | |
| | euro/m | 4,40 | 4,61 | 4,97 | 5,16 | 5,52 | - | 6,20 | - | |
| RB/ | bright polished silver | 92315 | 92316 | 92310 | 92312 | 92314 | 92061 | 92318 | - | |
| | euro/m | 6,46 | 6,68 | 6,96 | 7,54 | 8,33 | 8,83 | 9,38 | - | |
| RT/ | bright polished gold | 92325 | 92326 | 92340 | 92342 | 92344 | - | 92348 | - | |
| | bright polished titanium | 92015 | 92016 | 92018 | 92020 | 92022 | - | 92023 | - | |
| | euro/m | 6,68 | 6,88 | 7,18 | 7,76 | 8,58 | - | 9,67 | - | |
| RAS/ | bright satin silver | 92050 | 92051 | 92071 | 92073 | 92075 | 92062 | 92077 | - | |
| | bright satin gold | - | - | 92041 | 92043 | 92045 | - | 92047 | - | |
| RTM/ | bright satin titanium | 92053 | 92057 | 92064 | 92066 | 92068 | - | 92079 | - | |
| | euro/m | 7,97 | 8,17 | 8,56 | 8,78 | 9,57 | 10,07 | 10,66 | - | |
| COLOUR-COATED ALUMINIUM | | | | | | | | | | |
| RV/ | matt white RAL 9003 | - | - | - | 92107 | 92108 | 92109 | 92110 | - | |
| | white RAL 9003 | - | - | 92100 | 92102 | 92104 | 92111 | 92106 | - | |
| | euro/m | - | - | 4,83 | 5,38 | 5,81 | 6,04 | 6,25 | - | |
| ANTIBACTERIAL COLOUR-COATED ALUMINIUM | | | | | | | | | | |
| RVH/ | white RAL 9003 | - | - | - | 92112 | 92114 | - | 92116 | - | |
| | euro/m | - | - | - | 7,11 | 7,57 | - | 8,03 | - | |

individually packed

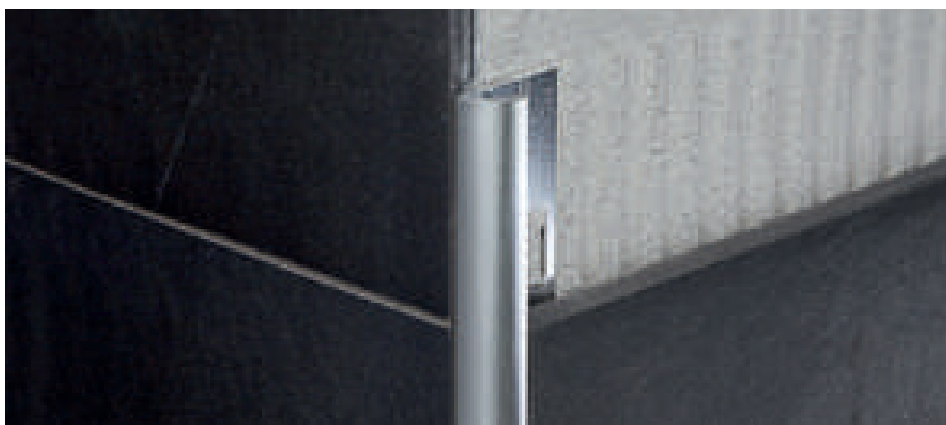











RAS/10 bright satin silver aluminium

Complete the article code with H measure (for example RA/ for H=8 becomes RA/8)

Items RV/ available in different colours on demand - minimum quantity 540 meters for colour









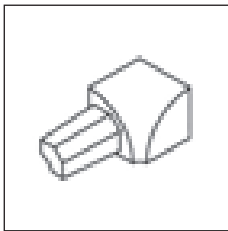

For a single piece, see sales conditions on page 288

**PROTRIM - OUTSIDE CORNER**

| pack 5 pcs* | | H | | | | | |
|--------------------------------|--------------------------|---|-------------|-------------|-------------|-------------|-------------|
| ART. | finishing | 6 | 8 | 10 | 11 | 12,5 | |
| ALUMINIUM | | | | | | | |
| TA/ | silver anodised |  | 92606 | 92608 | 92610 | 92600 | 92612 |
| | gold anodised |  | 92614 | 92616 | 92618 | - | 92619 |
| | titanium anodised |  | 92564 | 92566 | 92568 | - | 92569 |
| | <i>euro/pc</i> | | 4,20 | 4,20 | 4,20 | 4,20 | 4,20 |
| TB/ | bright polished silver |  | 92690 | 92692 | 92694 | 92601 | 92696 |
| | bright polished gold |  | 92700 | 92702 | 92704 | - | 92706 |
| TAT/ | bright polished titanium |  | 92724 | 92726 | 92728 | - | 92729 |
| | <i>euro/pc</i> | | 4,20 | 4,20 | 4,20 | 4,20 | 4,20 |
| TAS/ | bright satin silver |  | 92710 | 92711 | 92712 | 92602 | 92713 |
| | bright satin gold |  | 92720 | 92721 | 92722 | - | 92723 |
| TATM/ | bright satin titanium |  | 92714 | 92716 | 92718 | - | 92773 |
| | <i>euro/pc</i> | | 6,72 | 6,72 | 6,72 | 6,72 | 6,72 |
| COLOUR-COATED ALUMINIUM | | | | | | | |
| TV/ | matt white RAL 9003 |  | - | 92636 | 92637 | 92638 | 92639 |
| | white RAL 9003 |  | 92620 | 92622 | 92624 | 92628 | 92626 |
| | <i>euro/pc</i> | | 4,20 | 4,20 | 4,20 | 4,20 | 4,20 |

no partial packaging

**PROTRIM - INSIDE CORNER**

| pack 5 pcs* | | H | | | | | |
|--------------------------------|--------------------------|---|-------------|-------------|-------------|-------------|-------------|
| ART. | finishing | 6 | 8 | 10 | 11 | 12,5 | |
| ALUMINIUM | | | | | | | |
| TIA/ | silver anodised |  | 92570 | 92571 | 92572 | 92603 | 92573 |
| | gold anodised |  | 92575 | 92576 | 92577 | - | 92578 |
| | titanium anodised |  | 92554 | 92555 | 92556 | - | 92558 |
| | <i>euro/pc</i> | | 4,20 | 4,20 | 4,20 | 4,20 | 4,20 |
| TIB/ | bright polished silver |  | 92580 | 92581 | 92582 | 92604 | 92583 |
| | bright polished gold |  | 92585 | 92586 | 92587 | - | 92588 |
| TIAT/ | bright polished titanium |  | 92730 | 92732 | 92734 | - | 92736 |
| | <i>euro/pc</i> | | 4,20 | 4,20 | 4,20 | 4,20 | 4,20 |
| TIAS/ | bright satin silver |  | 92550 | 92551 | 92552 | 92605 | 92553 |
| | bright satin gold |  | 92560 | 92561 | 92562 | - | 92563 |
| | <i>euro/pc</i> | | 6,72 | 6,72 | 6,72 | 6,72 | 6,72 |
| COLOUR-COATED ALUMINIUM | | | | | | | |
| TIV/ | matt white RAL 9003 |  | - | 92646 | 92647 | 92648 | 92649 |
| | white RAL 9003 |  | 92621 | 92623 | 92625 | 92629 | 92627 |
| | <i>euro/pc</i> | | 4,20 | 4,20 | 4,20 | 4,20 | 4,20 |

no partial packaging

Complete the article code with H measure
(for example TA/ for H=8 becomes TA/8)

* available upon request pack of 1 pc in blister
+ 1,47 Euro (for example TA/6 code 92606
becomes 92606/B)

For a single piece, see sales conditions on page 288

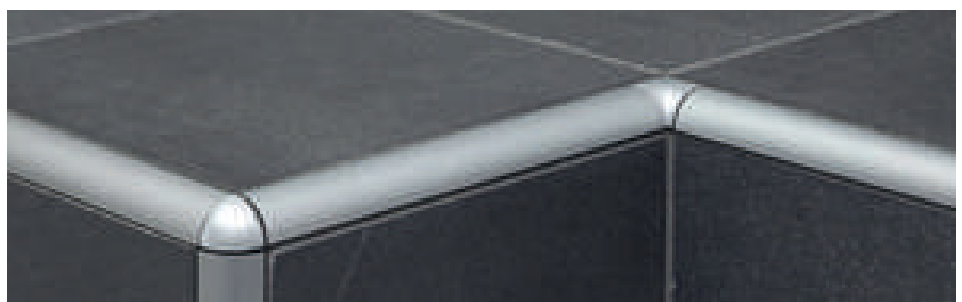

RA/10+TA/10+TIA/10 silver anodised aluminium

cerfix® protrim

Protrim in stainless steel is a line of profiles with rounded shape, specially designed to edge and protect the external corners of ceramic coverings and also recommended for floors, steps, worktops and platforms.

The AISI 304 versions are recommended for food industries, kitchens, hospitals and outdoor spaces, while the AISI 316 versions are suggested in case of difficult applications, such as swimming pools, spas and places exposed to salt.



RI/10 stainless steel AISI 304 DIN 1.4301

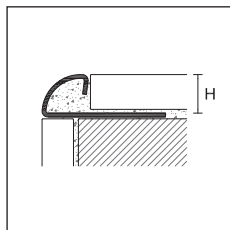

PROTRIM

length = 270 cm - pack 20 pcs

| ART. | finishing | | H | | | | | | | |
|------------------------|--|--|--------------|--------------|--------------|--------------|--------------|--------------|--------------|--------------|
| | | | 4,5 | 6 | 8 | 9 | 10 | 11 | 12,5 | 15 |
| STAINLESS STEEL | | | | | | | | | | |
| RI/ | stainless steel AISI 304 DIN 1.4301 | | 92413 | 92420 | 92422 | 92423 | 92424 | 92425 | 92426 | 92428 |
| | <i>euro/m</i> | | 8,27 | 9,01 | 9,63 | 10,10 | 10,40 | 10,67 | 11,05 | 12,41 |
| RIL/ | superpolished stainless steel AISI 304 - DIN 1.4301 | | 92415 | 92416 | 92417 | - | 92418 | - | 92419 | - |
| | <i>euro/m</i> | | 10,27 | 11,48 | 12,11 | - | 12,87 | - | 13,55 | - |
| RIS/ | satin stainless steel AISI 304 - DIN 1.4301 | | - | 92430 | 92431 | 92438 | 92432 | 92439 | 92433 | 92434 |
| | <i>euro/m</i> | | - | 10,79 | 11,40 | 11,88 | 12,17 | 12,46 | 12,83 | 14,20 |
| RIP/ | sandblasted stainless steel AISI 304 - DIN 1.4301 | | - | 92450 | 92451 | 92452 | 92453 | 92454 | 92455 | - |
| | <i>euro/m</i> | | - | 11,01 | 11,63 | 12,13 | 12,41 | 12,73 | 13,08 | - |
| RIX/ | stainless steel AISI 316 - DIN 1.4404 | | 92405 | 92406 | 92407 | 92410 | 92408 | 92411 | 92409 | - |
| | <i>euro/m</i> | | 10,70 | 11,51 | 12,38 | 12,87 | 13,26 | 13,62 | 14,15 | - |

individually packed - art. RI/15 pack 10 pcs



RIL/10 + TIEL/10 superpolished stainless steel

PROTRIM - OUTSIDE CORNER - pack 5 pcs

| | | | | | | | | | | |
|--------------|--|--|--------------|--------------|--------------|--------------|--------------|--------------|--------------|--------------|
| TIE/ | stainless steel AISI 304 - DIN 1.4301 | | 92750 | 92480 | 92481 | 92751 | 92482 | 92752 | 92483 | 92484 |
| | <i>euro/pc</i> | | 11,16 | 11,87 | 12,42 | 12,62 | 13,00 | 13,73 | 14,11 | 15,24 |
| TIEL/ | superpolished stainless steel AISI 304 - DIN 1.4301 | | 92790 | 92792 | 92794 | - | 92798 | - | 92802 | - |
| | <i>euro/pc</i> | | 12,05 | 12,81 | 13,38 | - | 14,04 | - | 15,05 | - |
| TIES/ | satin stainless steel AISI 304 - DIN 1.4301 | | - | 92485 | 92486 | 92753 | 92487 | 92754 | 92488 | 92489 |
| | <i>euro/pc</i> | | - | 12,81 | 13,38 | 13,65 | 14,04 | 14,69 | 15,05 | 16,35 |
| TIEP/ | sandblasted stainless steel AISI 304 - DIN 1.4301 | | - | 92510 | 92511 | 92512 | 92513 | 92514 | 92515 | - |
| | <i>euro/pc</i> | | - | 12,81 | 13,38 | 13,65 | 14,04 | 14,69 | 15,05 | - |
| TIEX/ | stainless steel AISI 316 - DIN 1.4404 | | 92500 | 92501 | 92502 | 92755 | 92503 | 92756 | 92504 | - |
| | <i>euro/pc</i> | | 12,97 | 13,73 | 14,30 | 14,50 | 14,88 | 15,61 | 16,00 | - |

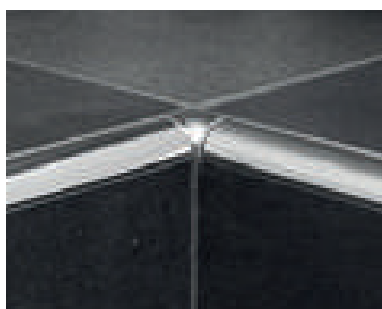

RIL/10 + TIIL/10 superpolished stainless steel

PROTRIM - INSIDE CORNER - pack 5 pcs

| | | | | | | | | | | |
|--------------|--|--|--------------|--------------|--------------|--------------|--------------|--------------|--------------|--------------|
| TII/ | stainless steel AISI 304 - DIN 1.4301 | | 92759 | 92490 | 92491 | 92757 | 92492 | 92758 | 92493 | 92494 |
| | <i>euro/pc</i> | | 11,66 | 12,42 | 13,00 | 13,73 | 14,11 | 14,88 | 15,24 | 16,38 |
| TIIL/ | stainless steel superpolished AISI 304 - DIN 1.4301 | | 92791 | 92793 | 92795 | - | 92799 | - | 92803 | - |
| | <i>euro/pc</i> | | 12,52 | 13,38 | 13,94 | - | 15,05 | - | 16,18 | - |
| TIIS/ | satin stainless steel AISI 304 - DIN 1.4301 | | - | 92495 | 92496 | 92760 | 92497 | 92761 | 92498 | 92499 |
| | <i>euro/pc</i> | | - | 13,38 | 13,94 | 14,69 | 15,05 | 15,72 | 16,18 | 17,48 |
| TIIP/ | sandblasted stainless steel AISI 304 - DIN 1.4301 | | - | 92516 | 92517 | 92518 | 92519 | 92520 | 92521 | - |
| | <i>euro/pc</i> | | - | 13,38 | 13,94 | 14,69 | 15,05 | 15,72 | 16,18 | - |
| TIIX/ | stainless steel AISI 316 - DIN 1.4404 | | 92505 | 92506 | 92507 | 92762 | 92508 | 92763 | 92509 | - |
| | <i>euro/pc</i> | | 13,53 | 14,30 | 14,88 | 15,61 | 16,00 | 16,66 | 17,12 | - |

Complete the article code with H measure (for example RI/ for H=8 becomes RI/8)

For a single piece, see sales conditions on page 288

METAL

OUTSIDE CORNER - pack 5 pcs

| | | | | | | | | | | |
|--------------|--------------------------|---|---|---|-------------|---|-------------|-------------|---|---|
| TIME/ | polished stainless steel |  | - | - | 92960 | - | 92964 | 92966 | - | - |
| | <i>euro/pc</i> | | - | - | 4,20 | - | 4,20 | 4,20 | - | - |

INSIDE CORNER - pack 5 pcs

| | | | | | | | | | | |
|--------------|--------------------------|---|---|---|-------------|---|-------------|-------------|---|---|
| TIMI/ | polished stainless steel |  | - | - | 92970 | - | 92974 | 92976 | - | - |
| | <i>euro/pc</i> | | - | - | 4,20 | - | 4,20 | 4,20 | - | - |

no partial packaging



RIN/10 stainless steel AISI 304 - DIN 1.4301

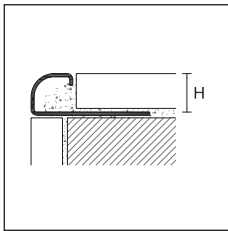

RIN/
RINS/
RINX/

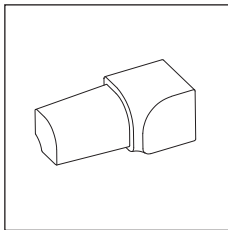

Complete the article code with H measure (for example RIN/ for H=8 becomes RIN/8)



Angles available on request pack of 1 pc in blister + 1,47 Euro (for example TIME/8 code 92960 becomes 92960/B)

For insertion and adjustment of corners TIME/ and TIMI/ we recommend the use of adhesive type PP/96

For a single piece, see sales conditions on page 288



PROTRIM N

length = 270 cm - pack 20 pcs



| ART. | finishing | | 8 | 10 | 12,5 |
|------------------------|---|---|--------------|--------------|--------------|
| STAINLESS STEEL | | | | | |
| RIN/ | stainless steel AISI 304 - DIN 1.4301 |  | 92353 | 92356 | 92359 |
| | <i>euro/m</i> | | 9,63 | 10,40 | 11,05 |
| RINS/ | satin stainless steel AISI 304 - DIN 1.4301 |  | 92354 | 92357 | 92360 |
| | <i>euro/m</i> | | 11,40 | 12,17 | 12,83 |
| RINX/ | stainless steel AISI 316 - DIN 1.4404 |  | 92355 | 92358 | 92361 |
| | <i>euro/m</i> | | 12,38 | 13,26 | 14,15 |

individually packed

PROTRIM N - OUTSIDE CORNER - pack 5 pcs

| | | | | | |
|---------------|---|---|--------------|--------------|--------------|
| TIEN/ | stainless steel AISI 304 - DIN 1.4301 |  | 92813 | 92816 | 92819 |
| | <i>euro/pc</i> | | 12,42 | 13,00 | 14,11 |
| TIENS/ | satin stainless steel AISI 304 - DIN 1.4301 |  | 92814 | 92817 | 92820 |
| | <i>euro/pc</i> | | 13,38 | 14,04 | 15,05 |
| TIENX/ | stainless steel AISI 316 - DIN 1.4404 |  | 92815 | 92818 | 92821 |
| | <i>euro/pc</i> | | 14,30 | 14,88 | 16,00 |

PROTRIM N - INSIDE CORNER - pack 5 pcs

| | | | | | |
|---------------|---|---|--------------|--------------|--------------|
| TIIN/ | stainless steel AISI 304 - DIN 1.4301 |  | 92828 | 92831 | 92834 |
| | <i>euro/pc</i> | | 13,00 | 14,11 | 15,24 |
| TIINS/ | satin stainless steel AISI 304 - DIN 1.4301 |  | 92829 | 92832 | 92835 |
| | <i>euro/pc</i> | | 13,94 | 15,05 | 16,18 |
| TIINX/ | stainless steel AISI 316 - DIN 1.4404 |  | 92830 | 92833 | 92836 |
| | <i>euro/pc</i> | | 14,88 | 16,00 | 17,12 |

cerfix® protrim

Protrim in polished brass is classic and modern at the same time and can be easily combined to handles, taps and other furniture accessories of the same material and finish.

The chromium-plated version stands out for its brilliance and is perfect as decorative element in spaces characterized by elegance and attention to details.



RKN/10 chromium-plated brass

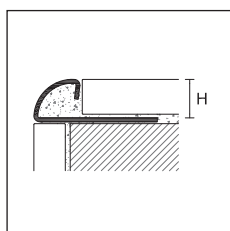



RLN/
RKN/

PPDESIGN

PROTRIM

length = 270 cm - pack 20 pcs

| | | H | | | | |
|------------------------------|-----------------|---|-------|-------|-------|-------|
| ART. | finishing | 6 | 8 | 10 | 12,5 | |
| POLISHED BRASS | | | | | | |
| RLN/ | polished |  | 92465 | 92466 | 92467 | 92468 |
| | euro/m | | 17,96 | 18,50 | 19,81 | 20,74 |
| CHROMIUM-PLATED BRASS | | | | | | |
| RKN/ | chromium plated |  | 92469 | 92470 | 92471 | 92472 |
| | euro/m | | 23,00 | 23,77 | 25,10 | 26,04 |



individually packed - art. RLN/10, RLN/12,5, RKN/10, RKN/12,5 packaging of 10 pcs



TB/
TIEL/

PROTRIM - OUTSIDE / INSIDE CORNERS

pack 5 pcs

| | | H | | | | |
|--|----------------------|---|-------|-------|-------|-------|
| ART. | finishing | 6 | 8 | 10 | 12,5 | |
| OUTSIDE CORNERS FOR RLN/ ARTICLES | | | | | | |
| ALUMINIUM | | | | | | |
| TB/ | bright polished gold |  | 92700 | 92702 | 92704 | 92706 |
| | euro/pc | | 4,20 | 4,20 | 4,20 | 4,20 |
| INSIDE CORNERS FOR RLN/ ARTICLES | | | | | | |
| ALUMINIUM | | | | | | |
| TIB/ | bright polished gold |  | 92585 | 92586 | 92587 | 92588 |
| | euro/pc | | 4,20 | 4,20 | 4,20 | 4,20 |

no partial packaging

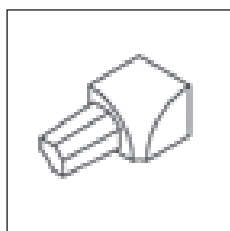

TIB/
TIIL/

pack 5 pcs

OUTSIDE CORNERS IN SUPERPOLISHED STAINLESS STEEL FOR RKN/ ITEMS

STAINLESS STEEL

| | | | | | | |
|-------|--|---|-------|-------|-------|-------|
| TIEL/ | superpolished stainless steel AISI 304 DIN 1.4301 |  | 92792 | 92794 | 92798 | 92802 |
| | euro/pc | | 12,81 | 13,38 | 14,04 | 15,05 |

INSIDE CORNERS IN SUPERPOLISHED STAINLESS STEEL FOR RKN/ ITEMS

STAINLESS STEEL

| | | | | | | |
|-------|--|---|-------|-------|-------|-------|
| TIIL/ | superpolished stainless steel AISI 304 DIN 1.4301 |  | 92793 | 92795 | 92799 | 92803 |
| | euro/pc | | 13,38 | 13,94 | 15,05 | 16,18 |

Complete the article code with H measure
(for example RLN/ for H=8 becomes RLN/8)

For a single piece, see sales conditions on page 288

Protrim in coextruded PVC is a line of profiles with rounded shape, specially designed to edge and protect the external corners of ceramic coverings. Their shape also acts as symmetric finishing and helps preventing accidents. Thanks to the special section with soft PVC inserts, these profiles absorb the micro-movements that discharge on the corner due to the tension of the wall coverings. Mass-dye coloured, they are available in many different colours and can be used in the most varied spaces.



RPA/8 white co-extruded PVC

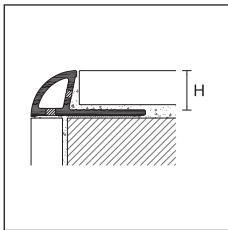

RPA/

PROTRIM

length = 270 cm - pack 20/100 pcs

| | | H | | |
|---------------------|----------------------|-----------------|-------------|-------------|
| | | CO-EXTRUDED PVC | | |
| ART. | finishing | 6 | 8 | 10 |
| | snow white | 80640 | 80641 | 80642 |
| | white | 80644 | 80645 | 80646 |
| | cream white RAL 9001 | 80648 | 80649 | 80650 |
| | ivory RAL 1015 | 80652 | 80653 | 80654 |
| RPA/ | beige grey RAL 1019 | 80656 | 80657 | 80658 |
| | stone grey RAL 7030 | 80660 | 80661 | 80662 |
| | ash grey RAL 7038 | 80664 | 80665 | 80666 |
| | light grey RAL 7035 | 80668 | 80669 | 80670 |
| | beige bahama | 80680 | 80681 | 80682 |
| | brown | 80692 | 80693 | 80694 |
| pack 20 pcs | | | | |
| euro/m | | 1,24 | 1,34 | 1,45 |
| pack 100 pcs | | | | |
| euro/m | | 1,01 | 1,11 | 1,22 |

no partial packaging

To order profiles in packs of 100 pcs, mark /100 after article code (for example code 80640 becomes 80640/100)

PROTRIM

pack 12 pcs*

| | | H | | | | | |
|----------------------|--|----------------|-------------|-------------|---------------|-------------|-------------|
| | | TPAE/ | | | TPAI/ | | |
| | | POLYPROPYLENE | | | | | |
| | | OUTSIDE CORNER | | | INSIDE CORNER | | |
| finishing | | 6 | 8 | 10 | 6 | 8 | 10 |
| snow white | | 80700 | 80701 | 80702 | 80753 | 80751 | 80752 |
| white | | 80703 | 80704 | 80705 | 80750 | 80754 | 80755 |
| cream white RAL 9001 | | 80706 | 80707 | 80708 | 80756 | 80757 | 80758 |
| ivory RAL 1015 | | 80709 | 80710 | 80711 | 80759 | 80760 | 80761 |
| beige grey RAL 1019 | | 80712 | 80713 | 80714 | 80762 | 80763 | 80764 |
| stone grey RAL 7030 | | 80715 | 80716 | 80717 | 80765 | 80766 | 80767 |
| ash grey RAL 7038 | | 80718 | 80719 | 80720 | 80768 | 80769 | 80770 |
| light grey RAL 7035 | | 80721 | 80722 | 80723 | 80771 | 80772 | 80773 |
| beige bahama | | 80730 | 80731 | 80732 | 80780 | 80781 | 80782 |
| brown | | 80739 | 80740 | 80741 | 80789 | 80790 | 80791 |
| euro/pc | | 0,97 | 0,97 | 0,97 | 0,97 | 0,97 | 0,97 |

To order corners in packs of 50 pcs, mark /50 after article code (for example code 80700 becomes 80700/50) - pack of 50 pcs Euro 0,74/pc

Complete the article code with H measure (for example RPA/ for H=8 becomes RPA/8)

* available upon request pack of 1 pc in blister + 1,47 Euro (for example TPAE/8 code 80701 becomes 80701/B)

For a single piece, see sales conditions on page 288

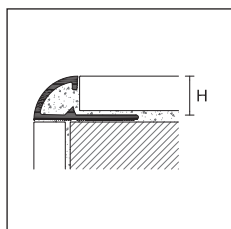

RE/

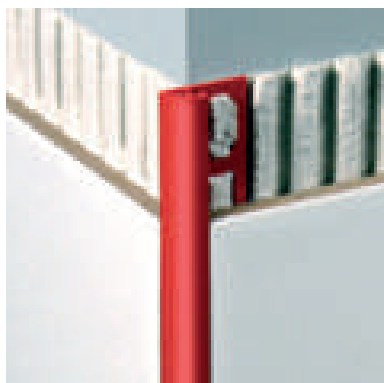

RE/8 PVC red RAL 3002

PROTRIM

lengt = 270 cm - pack 20/100 pcs

| | | H | | | |
|------------------------------|----------------------|-------------|-------------|-------------|-------------|
| | | PVC | | | |
| ART. | finishing | 6 | 8 | 10 | 12,5 |
| | snow white | 79996 | 79997 | 79998 | 79999 |
| | white | 80100 | 80101 | 80102 | 80103 |
| | cream white RAL 9001 | 80104 | 80105 | 80106 | 80107 |
| | ivory RAL 1015 | 80108 | 80109 | 80110 | - |
| | beige grey RAL 1019 | 80112 | 80113 | 80114 | - |
| | stone grey RAL 7030 | 80116 | 80117 | 80118 | - |
| | ash grey RAL 7038 | 80120 | 80121 | 80122 | - |
| | light grey RAL 7035 | 80124 | 80125 | 80126 | 80127 |
| | anthracite | 80175 | 80176 | 80177 | - |
| | blue | 80160 | 80161 | 80162 | - |
| | pastel blue | 80140 | 80141 | 80142 | - |
| | light green | 80179 | 80180 | 80181 | - |
| | red RAL 3002 | 80128 | 80129 | 80130 | - |
| | black RAL 9005 | 80132 | 80133 | 80134 | - |
| | yellow RAL 1023 | 80136 | 80137 | 80138 | - |
| | pastel pink | 80144 | 80145 | 80146 | - |
| | beige bahama | 80150 | 80151 | 80152 | - |
| | peach | 80154 | 80155 | 80156 | - |
| | caramel | 80164 | 80165 | 80166 | - |
| | brown | 80168 | 80169 | 80170 | - |
| | dark brown | 80172 | 80173 | 80174 | - |
| | coral red | 80187 | 80188 | 80189 | - |
| | raw sienna | 80191 | 80192 | 80193 | - |
| | terracotta | 80195 | 80362 | 80194 | - |
| pack 20 pcs - euro/m | | 1,19 | 1,28 | 1,39 | 1,49 |
| pack 100 pcs - euro/m | | 0,96 | 1,05 | 1,16 | 1,26 |

RE/

Complete the article code with H measure (for example RE/ for H=8 becomes RE/8)

For a single piece, see sales conditions on page 288

no partial packaging - to order the pack of 100 pcs, mark /100 after article code

PROTRIM

pack 12 pcs*

| | | H | | | | H | | | |
|----------------|----------------------|----------------|-------------|-------------|-------------|---------------|-------------|-------------|-------------|
| | | TE/ | | | | TE/ | | | |
| | | POLYPROPYLENE | | | | | | | |
| | | OUTSIDE CORNER | | | | INSIDE CORNER | | | |
| ART. | finishing | 6 | 8 | 10 | 12,5 | 6 | 8 | 10 | 12,5 |
| | snow white | 80396 | 80397 | 80398 | 80399 | 79800 | 79801 | 79802 | 79803 |
| | white | 80400 | 80401 | 80402 | 80403 | 79804 | 79805 | 79806 | 79807 |
| | cream white RAL 9001 | 80404 | 80405 | 80406 | 80407 | 79808 | 79809 | 79810 | 79811 |
| | ivory RAL 1015 | 80408 | 80409 | 80410 | - | 79812 | 79813 | 79814 | - |
| | beige grey RAL 1019 | 80412 | 80413 | 80414 | - | 79816 | 79817 | 79818 | - |
| | stone grey RAL 7030 | 80416 | 80417 | 80418 | - | 79820 | 79821 | 79822 | - |
| | ash grey RAL 7038 | 80420 | 80421 | 80422 | - | 79824 | 79825 | 79826 | - |
| | light grey RAL 7035 | 80424 | 80425 | 80426 | 80427 | 79828 | 79829 | 79830 | 79831 |
| | anthracite | 80479 | 80480 | 80481 | - | 79875 | 79876 | 79877 | - |
| | blue | 80470 | 80471 | 80472 | - | 79848 | 79849 | 79850 | - |
| | pastel blue | 80440 | 80441 | 80442 | - | 79844 | 79845 | 79846 | - |
| | light green | 80475 | 80476 | 80477 | - | 79879 | 79880 | 79881 | - |
| | red RAL 3002 | 80428 | 80429 | 80430 | - | 79832 | 79833 | 79834 | - |
| | black RAL 9005 | 80432 | 80433 | 80434 | - | 79836 | 79837 | 79838 | - |
| | yellow RAL 1023 | 80436 | 80437 | 80438 | - | 79840 | 79841 | 79842 | - |
| | pastel pink | 80444 | 80445 | 80446 | - | 79852 | 79853 | 79854 | - |
| | beige bahama | 80448 | 80449 | 80450 | - | 79856 | 79857 | 79858 | - |
| | peach | 80452 | 80453 | 80454 | - | 79860 | 79861 | 79862 | - |
| | caramel | 80458 | 80459 | 80460 | - | 79864 | 79865 | 79866 | - |
| | brown | 80462 | 80463 | 80464 | - | 79868 | 79869 | 79870 | - |
| | dark brown | 80466 | 80467 | 80468 | - | 79872 | 79873 | 79874 | - |
| | coral red | 80483 | 80484 | 80485 | - | 79887 | 79888 | 79889 | - |
| | raw sienna | 80487 | 80488 | 80489 | - | 79891 | 79892 | 79893 | - |
| | terracotta | 80491 | 80492 | 80493 | - | 79895 | 79896 | 79897 | - |
| euro/pc | | 0,97 | 0,97 | 0,97 | 0,97 | 0,97 | 0,97 | 0,97 | 0,97 |

no partial packaging

* available upon request pack of 1 pc in blister + 1,47 Euro (for example TE/8 code 80397 becomes 80397/B) - To order corners in packs of 50 pcs, mark /50 after article code (for example code 80396 becomes 80396/50) pack of 50 pcs. €/pcs 0,74 - For a single piece, see sales conditions on page 288

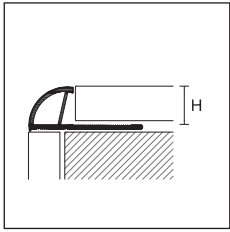

RECO/

PROTRIM ECO

length = 260 cm - pack 80 pcs

| ART. | finishing | ECOLINE PVC | | | |
|------------------|----------------------|-------------|-------------|-------------|-------------|
| | | 6 | 8 | 10 | |
| | snow white | | 79400 | 79401 | 79402 |
| | white | | 79403 | 79404 | 79405 |
| | cream white RAL 9001 | | 79406 | 79407 | 79408 |
| RECO/ /80 | ivory RAL 1015 | | 79409 | 79410 | 79411 |
| | ash grey RAL 7038 | | 79412 | 79413 | 79414 |
| | light grey RAL 7035 | | 79415 | 79416 | 79417 |
| | beige bahama | | 79418 | 79419 | 79420 |
| | euro/m | | 0,69 | 0,76 | 0,84 |

no partial packaging

others colour on request for minimum 2600 mt for colour

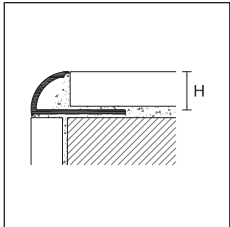

REC/

PROTRIM ECO

length = 260 cm - pack 100 pcs

| ART. | finishing | ECOLINE PVC | | | |
|------------------|----------------------|-------------|---|-------------|-------------|
| | | - | 8 | 10 | |
| | snow white | | - | 79601/100 | 79602/100 |
| | cream white RAL 9001 | | - | 79605/100 | 79606/100 |
| | ivory RAL 1015 | | - | - | 79610/100 |
| | beige grey RAL 1019 | | - | - | 79614/100 |
| REC/ /100 | stone grey RAL 7030 | | - | - | 79618/100 |
| | ash grey RAL 7038 | | - | - | 79622/100 |
| | light grey RAL 7035 | | - | - | 79626/100 |
| | beige bahama | | - | - | 79642/100 |
| | euro/m | | - | 0,67 | 0,74 |

no partial packaging

others colour on request for minimum 2600 mt for colour

Complete the article code with H measure
(for example REC/ /100 for H=8 becomes
REC/8/100)

For a single piece, see sales conditions on page 288 *REC/10 white PVC ecoline*



external corners profiles

cerfix® proangle F

Proangle F is a triangular profile indicated as a decorative element and closing of the outside corners of the tiles.

The stainless steel version with reduced base is rather suitable for the protection and finishing of the interior angles of ceramic coverings.



FMB/10 + FMBE/10 bright polished silver aluminium

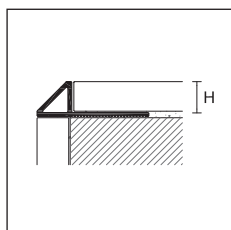

FMA/
FMB/

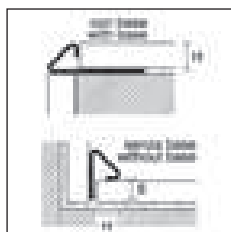

FMI/
FMIS/

PROANGLE F

length = 270 cm - pack 20 pcs

| ART. finishing | | H | | |
|------------------|------------------------|-------------|-------------|-------------|
| | | 8 | 10 | 12,5 |
| ALUMINIUM | | | | |
| FMA/ | silver anodised | 93025 | 93026 | 93027 |
| | <i>euro/m</i> | 4,62 | 5,00 | 5,69 |
| FMB/ | bright polished silver | 93028 | 93029 | 93030 |
| | <i>euro/m</i> | 7,93 | 8,75 | 9,86 |

individually packed

PROANGLE F

length = 270 cm - pack 20 pcs

| ART. finishing | | H | | | |
|------------------------|--|--------------|--------------|--------------|--------------|
| | | 8 | | 10 | |
| STAINLESS STEEL | | | | | |
| | | with base | without base | with base | without base |
| FMI/ | stainless steel AISI 304 - DIN 1.4301 | 93050 | 93051 | 93052 | 93053 |
| | <i>euro/m</i> | 9,77 | 8,75 | 10,07 | 9,06 |
| FMIS/ | satin stainless steel AISI 304 - DIN 1.4301 | 93054 | 93055 | 93056 | 93057 |
| | <i>euro/m</i> | 12,51 | 11,50 | 13,09 | 12,11 |

individually packed

OUTSIDE CORNER

pack 5 pcs*

| ART. finishing | | H | | |
|------------------|------------------------|-------------|-------------|-------------|
| | | 8 | 10 | 12,5 |
| ALUMINIUM | | | | |
| FMAE/ | silver anodised | 93031 | 93032 | 93033 |
| | <i>euro/pc</i> | 8,85 | 8,85 | 8,85 |
| FMBE/ | bright polished silver | 93040 | 93041 | 93042 |
| | <i>euro/pc</i> | 8,85 | 8,85 | 8,85 |

INSIDE CORNER

pack 5 pcs*

| ART. finishing | | H | | |
|------------------|------------------------|-------------|-------------|-------------|
| | | 8 | 10 | 12,5 |
| ALUMINIUM | | | | |
| FMAI/ | silver anodised | 93034 | 93035 | 93036 |
| | <i>euro/pc</i> | 8,85 | 8,85 | 8,85 |
| FMBI/ | bright polished silver | 93043 | 93044 | 93045 |
| | <i>euro/pc</i> | 8,85 | 8,85 | 8,85 |

END CAP

pack 5 pcs*

| ART. finishing | | H | | |
|------------------|------------------------|-------------|-------------|-------------|
| | | 8 | 10 | 12,5 |
| ALUMINIUM | | | | |
| FMAC/ | silver anodised | 93037 | 93038 | 93039 |
| | <i>euro/pc</i> | 8,85 | 8,85 | 8,85 |
| FMBC/ | bright polished silver | 93046 | 93047 | 93048 |
| | <i>euro/pc</i> | 8,85 | 8,85 | 8,85 |

OUTSIDE CORNER

pack 5 pcs

| ART. finishing | | H | | |
|------------------------|--|--------------|--------------|--------------|
| | | 8 | 10 | 12,5 |
| STAINLESS STEEL | | | | |
| FMIE/ | stainless steel AISI 304 - DIN 1.4301 | 93058 | 93059 | 93060 |
| | <i>euro/pc</i> | 13,84 | 13,84 | 13,84 |
| FMIES/ | satin stainless steel AISI 304 - DIN 1.4301 | 93064 | 93065 | 93066 |
| | <i>euro/pc</i> | 15,55 | 15,55 | 15,55 |

INSIDE CORNER

pack 5 pcs

| ART. finishing | | H | | |
|------------------------|--|--------------|--------------|--------------|
| | | 8 | 10 | 12,5 |
| STAINLESS STEEL | | | | |
| FMII/ | stainless steel AISI 304 - DIN 1.4301 | 93060 | 93061 | 93062 |
| | <i>euro/pc</i> | 13,84 | 13,84 | 13,84 |
| FMIIS/ | satin stainless steel AISI 304 - DIN 1.4301 | 93066 | 93067 | 93068 |
| | <i>euro/pc</i> | 15,55 | 15,55 | 15,55 |

END CAP

pack 5 pcs

| ART. finishing | | H | | |
|------------------------|--|--------------|--------------|--------------|
| | | 8 | 10 | 12,5 |
| STAINLESS STEEL | | | | |
| FMIC/ | stainless steel AISI 304 - DIN 1.4301 | 93062 | 93063 | 93064 |
| | <i>euro/pc</i> | 12,79 | 12,79 | 12,79 |
| FMICS/ | satin stainless steel AISI 304 - DIN 1.4301 | 93068 | 93069 | 93070 |
| | <i>euro/pc</i> | 14,47 | 14,47 | 14,47 |

no partial packaging for aluminium accessories

* available upon request pack of 1 pc in blister + 1,47 Euro (for example FMAE/8 code 93031 becomes 93031/B) - Complete the article code with H measure (for example FMA/ for H=8 becomes FMA/8) - For a single piece, see sales conditions on page 288

cerfix® proangle AX - pronivel M

Proangle AX M Design is a profile in anodised or colour-coated aluminium, which finishes the vertical edge of the coverings, accentuating the discontinuity between the wall in an elegant way.



AX/2/ silver anodised aluminium

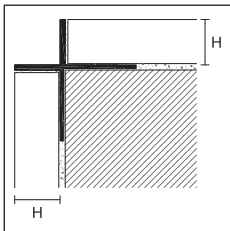

AX/2/

PROANGLE AX- M DESIGN

length = 270 cm - pack 10 pcs

| | | H | | |
|------------------|---------------------------------------|--------------|--------------|--------------|
| ART. | finishing | 6 | 10 | 12,5 |
| ALUMINIUM | | | | |
| | silver anodised | 13208 | 13209 | 13210 |
| | <i>euro/m</i> | 8,34 | 8,34 | 8,34 |
| AX/2/ | titanium anodised | 13211 | 13213 | 13212 |
| | colour-coated polished white RAL 9010 | 13215 | 13216 | 13214 |
| | <i>euro/m</i> | 12,16 | 12,16 | 12,16 |

individually packed

Pronivel M is a line of profiles designed to connect floors of different heights during the installation. Thanks to its shape, MIN/ can be also used as edging profile for the protection of 135-degree external corners of tile coverings.

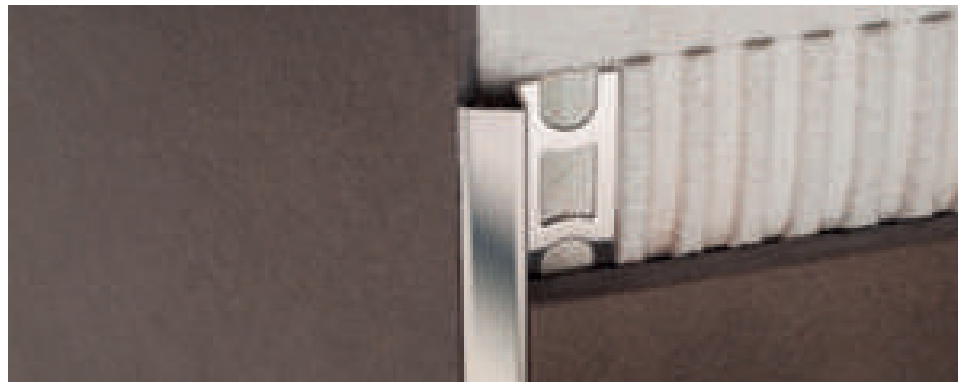

MIN/10 polished stainless steel AISI 304 DIN 1.4301

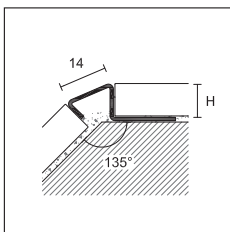

MIN/10

PRONIVEL M

length = 270 cm - pack 10 pcs

| | | H | |
|-------------|--|--------------|--------------|
| ART. | finishing | 8 | 10 |
| MIN/ | polished stainless steel AISI 304 - DIN 1.4301 | 93023 | 93024 |
| | <i>euro/m</i> | 10,12 | 11,12 |

individually packed

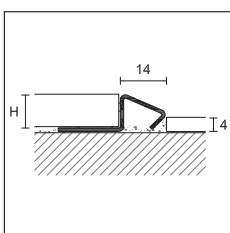

MIN/10 application for floors of different height

Complete the article code with H measure (for example AX/2/ for H=10 becomes AX/2/10)

Complete the article code with H measure (for example MIN/ for H=10 becomes MIN/10)

For a single piece, see sales conditions on page 288

cerfix® procorner M

Procorner M is a line of protection profiles of the outside corners of wall to be applied on the surfaces of the tiles already laid. Procorner profiles are also available in self-adhesive version for a quick and easy installation.



210/A silver anodised aluminium

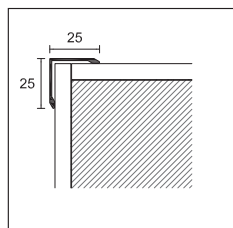

210/
210H/A

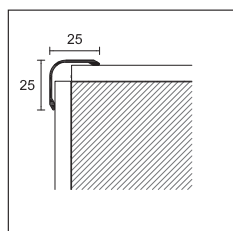

220/

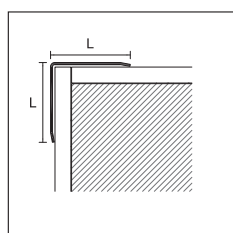

277/

Complete the article code with L measure (for example 277/SF/ for L= 20 becomes 277/SF/20)

Upon request, we can manufacture cerfix® procorner' with different dimensions. Please contact our technical department for further information.

For a single piece, see sales conditions on page 288

PROCORNER M

length = 300 cm - pack 30 pcs

LxL

25x25

| ART. | finishing | | /SF | /A |
|------------------|------------------------------|--|-------------|-------------|
| ALUMINIUM | | | | |
| | silver anodised | | 76068 | 76098 |
| | gold anodised | | - | 76108 |
| 210/ | euro/m | | 5,07 | 6,45 |
| | colour-coated white RAL 9003 | | 76128 | 76208 |
| | euro/m | | 6,63 | 8,00 |

SF = not drilled A = adhesive
individually packed

NEW PROCORNER M

length = 300 cm - pack 30 pcs

LxL

25x25

| ART. | finishing | | | |
|--|--|--|--------------|--|
| ANTIBACTERIAL COLOUR-COATED ALUMINIUM | | | | |
| | colour-coated antibacterial white RAL 9003 | | 76209 | |
| 210H/A | euro/m | | 12,45 | |

A = adhesive
individually packed

PROCORNER M

length = 300 cm - pack 30 pcs

LxL

25x25

| ART. | finishing | | /SF | /A |
|------------------|------------------------------|--|-------------|-------------|
| ALUMINIUM | | | | |
| | silver anodised | | 77888 | 77894 |
| 220/ | euro/m | | 6,26 | 7,62 |
| | colour-coated white RAL 9003 | | 77900 | - |
| | euro/m | | 7,85 | - |

SF = not drilled A = adhesive
individually packed

PROCORNER M

SILVER ANODISED ALUMINIUM

length = 300 cm - pack 30 pcs

| ART. | measure LxL | code | euro/m |
|------------------------|--------------|-------|-------------|
| 277/SF/ | 20x20 | 76308 | 4,80 |
| 277/A/ adhesive | 20x20 | 76309 | 6,18 |
| 277/SF/ | 25x25 | 76318 | 5,16 |
| 277/A/ adhesive | 25x25 | 76319 | 6,53 |
| 277/SF/ | 30x30 | 76328 | 5,66 |
| 277/A/ adhesive | 30x30 | 76329 | 7,02 |

individually packed



775/A/40 polished stainless steel AISI 304 DIN 1.4301

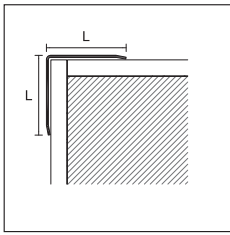

777/
776/

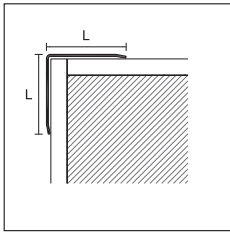

775/

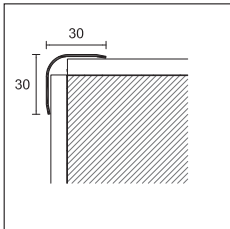

774/

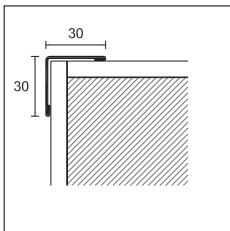

779/SF

Complete the article code with L measure (for example 777/SF/ for L=15 becomes 777/SF/15)

Upon request, we can manufacture cerfix® procorner with different dimensions. Please contact our technical department for further information.

For a single piece, see sales conditions on page 288

PROCORNER M

POLISHED STAINLESS STEEL AISI 430 DIN 1.4016

length = 300 cm - thickness = 0,60 mm

| ART. | measure LxL | code | euro/m | pack |
|-----------------|-------------|-------|--------|------|
| 777/SF/ | 15x15 | 76888 | 6,01 | 30 |
| 777/A/ adhesive | 15x15 | 76938 | 8,25 | 30 |
| 777/SF/ | 20x20 | 76898 | 7,30 | 30 |
| 777/A/ adhesive | 20x20 | 76948 | 9,50 | 30 |
| 777/SF/ | 25x25 | 76908 | 8,53 | 15 |
| 777/A/ adhesive | 25x25 | 76958 | 10,75 | 15 |
| 777/SF/ | 30x30 | 76918 | 9,85 | 20 |
| 777/A/ adhesive | 30x30 | 76968 | 12,04 | 20 |

length = 200 cm - thickness = 1 mm

| ART. | measure LxL | code | euro/m | pack |
|-----------------|-------------|-------|--------|------|
| 776/SF/ | 30x30 | 77004 | 13,01 | 20 |
| 776/A/ adhesive | 30x30 | 77044 | 15,03 | 20 |
| 776/SF/ | 40x40 | 77014 | 16,77 | 10 |
| 776/A/ adhesive | 40x40 | 77054 | 18,80 | 10 |
| 776/SF/ | 50x50 | 77024 | 19,97 | 10 |
| 776/A/ adhesive | 50x50 | 77064 | 21,97 | 10 |

length = 270 cm - thickness = 1 mm

| ART. | measure LxL | code | euro/m | pack |
|-----------------|-------------|-------|--------|------|
| 776/SF/ | 30x30 | 77008 | 13,01 | 10 |
| 776/A/ adhesive | 30x30 | 77048 | 15,03 | 10 |
| 776/SF/ | 40x40 | 77018 | 16,77 | 10 |
| 776/A/ adhesive | 40x40 | 77058 | 18,80 | 10 |
| 776/SF/ | 50x50 | 77028 | 19,97 | 5 |
| 776/A/ adhesive | 50x50 | 77068 | 21,97 | 5 |

POLISHED STAINLESS STEEL AISI 304 DIN 1.4301

length = 270 cm - thickness = 1 mm

| ART. | measure LxL | code | euro/m | pack |
|-----------------|-------------|-------|--------|------|
| 775/SF/ | 30x30 | 77108 | 16,17 | 10 |
| 775/A/ adhesive | 30x30 | 77148 | 18,20 | 10 |
| 775/SF/ | 40x40 | 77118 | 20,62 | 10 |
| 775/SF/ | 50x50 | 77128 | 24,60 | 5 |
| 775/A/ adhesive | 50x50 | 77168 | 26,60 | 5 |

SATIN STAINLESS STEEL AISI 304 DIN 1.4301

length = 270 cm - thickness = 1 mm

| ART. | measure LxL | code | euro/m | pack |
|---------|-------------|-------|--------|------|
| 775/SF/ | 30x30 | 77110 | 20,43 | 10 |
| 775/SF/ | 50x50 | 77130 | 33,01 | 5 |

POLISHED STAINLESS STEEL AISI 304 DIN 1.4301

length = 270 cm - thickness = 1 mm

| ART. | measure LxL | code | euro/m | pack |
|--------|-------------|-------|--------|------|
| 774/SF | 30x30 | 77954 | 18,85 | 10 |

SATIN STAINLESS STEEL AISI 304 DIN 1.4301

length = 270 cm - thickness = 1 mm

| ART. | measure LxL | code | euro/m | pack |
|--------|-------------|-------|--------|------|
| 779/SF | 30x30 | 77106 | 25,96 | 10 |

SF = not drilled A = adhesive

cerfix® procorner M - procorner P

Procorner M is a profile for the protection of the external corners of coverings. Recommended in places such as schools, offices, kindergartens and public spaces, it is available in polished brass to highlight the covering corners.

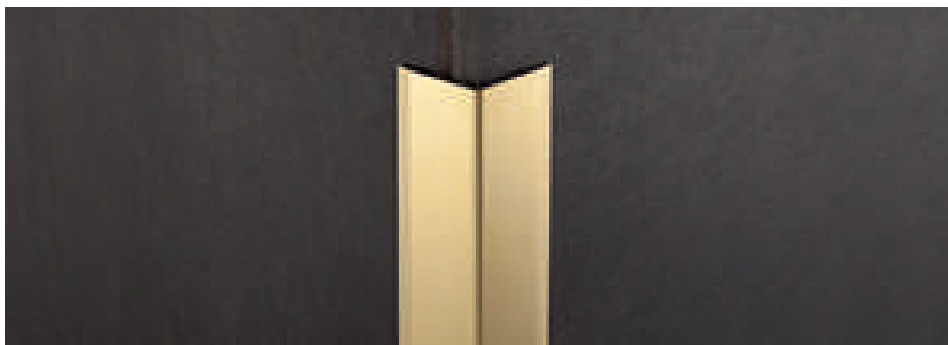

076/A/30 polished brass

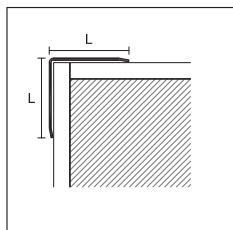

076/SF/
076/A/

PROCORNER M

POLISHED BRASS

length = 270 cm - thickness = 1,00 mm

| ART. | measure LxL | code | euro/m | pack |
|------------------------|--------------|-------|--------------|------|
| 076/SF/ | 15x15 | 76800 | 14,19 | 30 |
| 076/A/ adhesive | 15x15 | 76840 | 16,61 | 15 |
| 076/SF/ | 20x20 | 76802 | 17,51 | 15 |
| 076/A/ adhesive | 20x20 | 76842 | 19,93 | 15 |
| 076/SF/ | 25x25 | 76806 | 20,84 | 15 |
| 076/A/ adhesive | 25x25 | 76846 | 23,27 | 10 |
| 076/SF/ | 30x30 | 76808 | 23,87 | 10 |
| 076/A/ adhesive | 30x30 | 76848 | 26,28 | 10 |

SF = not drilled A = adhesive

Procorner P is an edge profile to protect from many issues. Recommended in environments such as schools, offices, kindergartens, public spaces, it is made of PVC soft and in bright colors to visually highlight the edges of the wall.

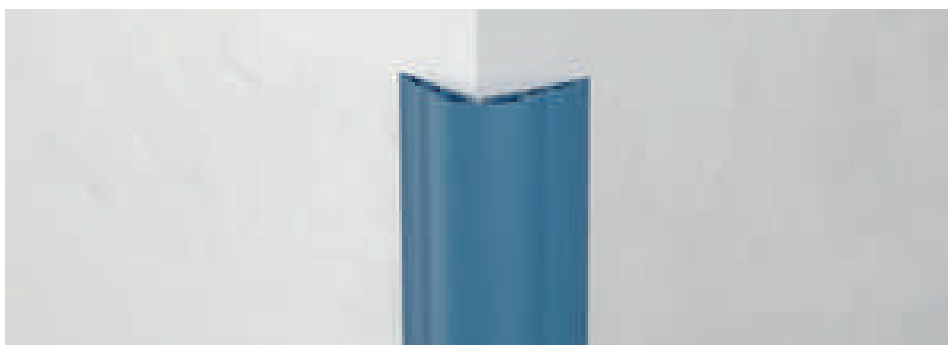

IP/40 blue soft PVC

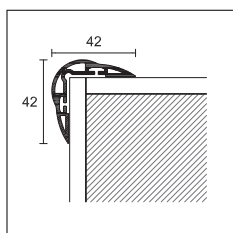

IP/40

PROCORNER P

length = 270 cm - pack 20 pcs

| ART. | finishing | LxL |
|-----------------|---------------|-------------|
| SOFT PVC | | |
| | white | 95010 |
| | yellow | 95011 |
| IP/40 | red | 95012 |
| | blue | 95013 |
| | euro/m | 4,41 |

Complete the article code with H measure (for example 076/SF/ for L=15 becomes 076/SF/15)

Upon request, we can manufacture cerfix® procorner with different dimensions. Please contact our technical department for further information.

Article IP/40 in PVC should be stored horizontally

For a single piece, see sales conditions on page 288

PVC Line 8610 and 8611 are a line of edging profiles in foam PVC that are impact resistant. Quick and easy to install, they are particularly suitable for DIY installations. Available in different vivid colours, they are suitable for places like schools, kindergartens and public spaces in general.

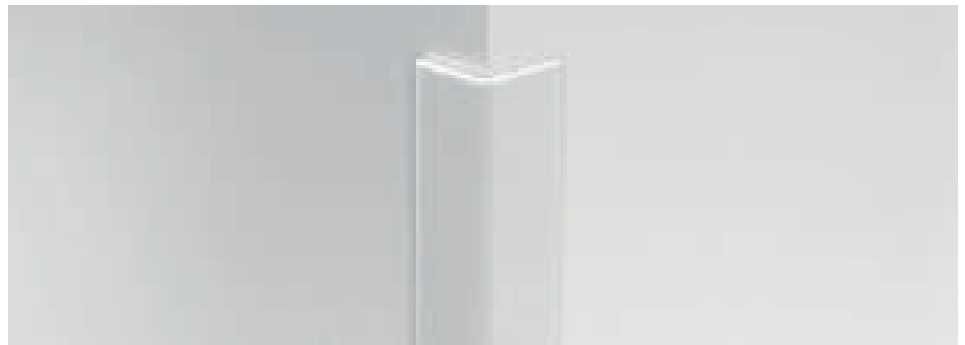

8610 white dec. 555

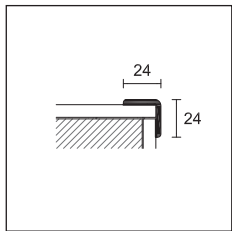

8610

PVC LINE

length 300 cm - pack 20/50 pcs

FOAM PVC

| ART. | decors | | decors | | decors | |
|-------------|--------|-------|----------------|-------|----------------|-------|
| | 518 | 29810 | 536 | 29830 | yellow 561 | 29848 |
| | 520 | 29812 | 540 | 29832 | green 562 | 29850 |
| | 524 | 29814 | 542 | 29834 | light blue 563 | 29847 |
| | 525 | 29816 | 544 | 29836 | red 564 | 29849 |
| 8610 | 528 | 29818 | 545 | 29838 | | |
| | 530 | 29820 | white 555 | 29840 | | |
| | 531 | 29822 | light grey 556 | 29842 | | |
| | 532 | 29824 | black 557 | 29844 | | |
| | 534 | 29828 | anthracite 558 | 29846 | | |

pack 20 pcs

euro/m

1,35

1,39

pack 50 pcs

euro/m

1,07

1,10

no partial packaging

PVC LINE

length 300 cm - pack 20/50 pcs

FOAM PVC

| ART. | decors | | decors | | decors | | decors | |
|-------------|--------|-------|----------------|-------|----------------|-------|-----------------|------------------|
| | 518 | 29910 | white 555 | 29940 | yellow 561 | 29946 | silver dec. 559 | NEW 29949 |
| 8611 | 532 | 29924 | light grey 556 | 29942 | green 562 | 29948 | | |
| | 542 | 29934 | black 557 | 29944 | light blue 563 | 29945 | | |
| | 545 | 29938 | | | red 564 | 29947 | | |

pack 20 pcs

euro/m

1,46

1,49

1,77

pack 50 pcs

euro/m

1,18

1,21

1,47

no partial packaging



8610 dec. 532

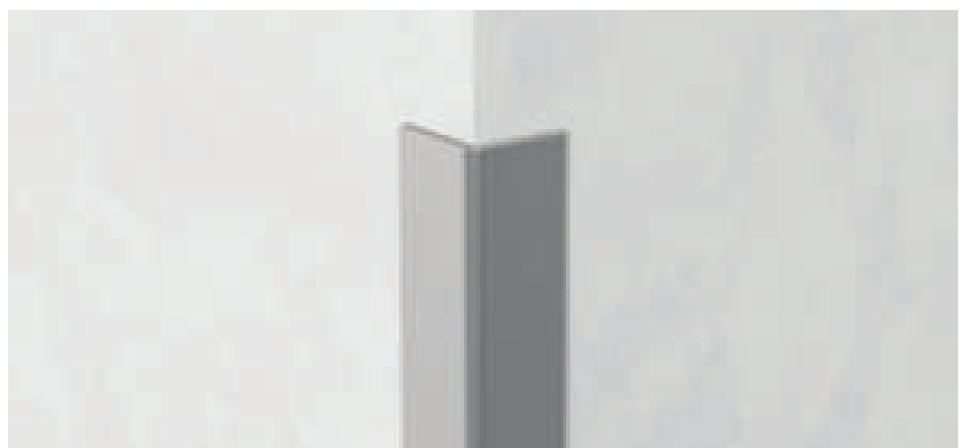

8611 silver dec. 559

Skirting board available with the same decors on page 221

external corners profiles

cerfix® probord

Stainless steel Probord ILN is a security profile for the outside corners of wall tiles. It can be combined with the profiles Proround M and it is recommended for the prevention of accidents and in environments where high hygienic safety is also required such as kitchens, food industries, schools etc.. The version in AISI 316 stainless steel is suitable for swimming pools, spa and in environments exposed to salt.



ILN/10 polished stainless steel AISI 304 DIN 1.4301

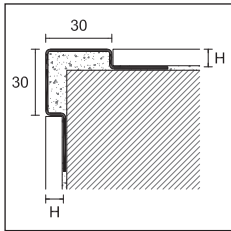

ILN/
ILNS/
ILNX/

PROBORD

length = 270 cm - pack 5 pcs

| ART. finishing | | H | | |
|------------------------|---|--------------|--------------|--------------|
| | | 8 | 10 | 12,5 |
| STAINLESS STEEL | | | | |
| ILN/ | polished stainless steel AISI 304 - DIN 1.4301 | 94997 | 94998 | 94999 |
| | <i>euro/m</i> | 22,35 | 23,53 | 24,72 |
| ILNS/ | satin stainless steel AISI 304 - DIN 1.4301 | 94984 | 94985 | 94986 |
| | <i>euro/m</i> | 26,63 | 27,80 | 28,96 |
| ILNX/ | stainless steel AISI 316 - DIN 1.4404 | 94987 | 94988 | 94989 |
| | <i>euro/m</i> | 34,07 | 35,35 | 36,41 |

individually packed

Probord IL, ILE and ILES have a rounded angle (compared to the model ILN). The fixing system with a single flange favors the correct alignment of the profile even in the presence of corners and uneven surfaces.



IL/10 polished stainless steel AISI 304 DIN 1.4301

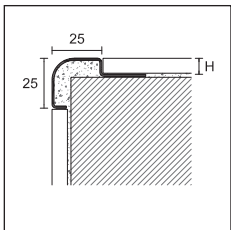

IL/

PROBORD

length = 270 cm - pack 10 pcs

| ART. finishing | | H | | |
|------------------------|--|--------------|--------------|--------------|
| | | 8 | 10 | 12,5 |
| STAINLESS STEEL | | | | |
| IL/ | stainless steel AISI 304 - DIN 1.4301 | 94994 | 94995 | 94996 |
| | <i>euro/m</i> | 18,64 | 19,18 | 19,72 |

individually packed

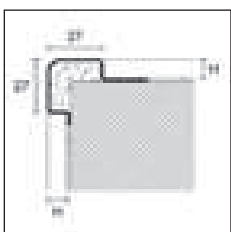

ILE/
ILES/

PROBORD

length = 270 cm - pack 5 pcs

| ART. finishing | | H | | |
|------------------------|---|----|--------------|--|
| | | 10 | | |
| STAINLESS STEEL | | | | |
| ILE/10 | polished stainless steel AISI 304 - DIN 1.4301 | | 95002 | |
| | <i>euro/m</i> | | 19,67 | |
| ILES/10 | satin stainless steel AISI 304 - DIN 1.4301 | | 95003 | |
| | <i>euro/m</i> | | 21,63 | |

individually packed

Upon request, we can manufacture ILE/ and ILES/ with different dimensions or in stainless steel AISI 316 - DIN 1.4404.

Complete the article code with H measure (for example ILN/ for H=8 becomes ILN/8)

Upon request, we can manufacture cerfix profiles, probord ILN/ and IL/ with different dimensions.

Please contact our technical department for further information.

For a single piece, see sales conditions on page 288

Cerfix Protop® is a profile for the protection and finishing of external corners of worktops and ceramic-coated kitchens. Also recommended for running boards and steps made with tiles.



TOP/A/10 silver anodised aluminium

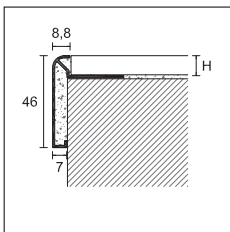

TOP/A/
TOP/TM/

PROTOP

length = 270 cm - pack 10 pcs

| | | H | |
|------------------|-----------------------|-------|-------|
| ART. | finishing | 10 | 12 |
| ALUMINIUM | | | |
| TOP/A/ | silver anodised | 86050 | 86060 |
| | euro/m | 12,24 | 12,54 |
| TOP/TM/ | titanium anodised | 86052 | 86062 |
| | euro/m | 12,24 | 12,54 |
| TOP/TM/ | bright satin titanium | 86051 | 86061 |
| | euro/m | 19,97 | 20,22 |

individually packed

OUTSIDE CORNER - pack 2 pcs

| | | 90° | 135° | 90° | 135° |
|------------------|-----------------------|-------|-------|-------|-------|
| ALUMINIUM | | | | | |
| TOP/E | silver anodised | 86074 | 86072 | 86074 | 86072 |
| | titanium anodised | 86080 | 86082 | 86080 | 86082 |
| TOP/ETM | euro/pc | 17,89 | 17,89 | 17,89 | 17,89 |
| | bright satin titanium | 86075 | 86073 | 86075 | 86073 |
| TOP/ETM | euro/pc | 20,76 | 20,76 | 20,76 | 20,76 |

INSIDE CORNER - pack 2 pcs

| | | 90° | 135° | 90° | 135° |
|------------------|-----------------------|-------|-------|-------|-------|
| ALUMINIUM | | | | | |
| TOP/I | silver anodised | 86078 | 86076 | 86078 | 86076 |
| | titanium anodised | 86081 | 86083 | 86081 | 86083 |
| TOP/ITM | euro/pc | 17,89 | 17,89 | 17,89 | 17,89 |
| | bright satin titanium | 86079 | 86077 | 86079 | 86077 |
| TOP/ITM | euro/pc | 20,76 | 20,76 | 20,76 | 20,76 |

no partial packaging



TOP/A/10 + TOP/90/E + TOP/135/I silver anodised aluminium

Complete the article code with H measure (for example TOP/A/ for H=10 becomes TOP/A/10)

For a single piece, see sales conditions on page 288





listellos and decorative profiles

The line of decorative listellos provides a wide variety of finishes, suitable for endless combinations and multiple aesthetic architectural tastes, from classic to contemporary; they are applicable to all environments with ceramic tiles from kitchen to bathroom, from living rooms to large commercial spaces.

Prolist is a range of decorative listellos designed to create stylish and eye-catching aesthetic effects of wall tiles. They are available in different materials and colors, and can be coordinated to the profiles of the ranges PROTRIM and Proangle to obtain elegant and sophisticated combinations.

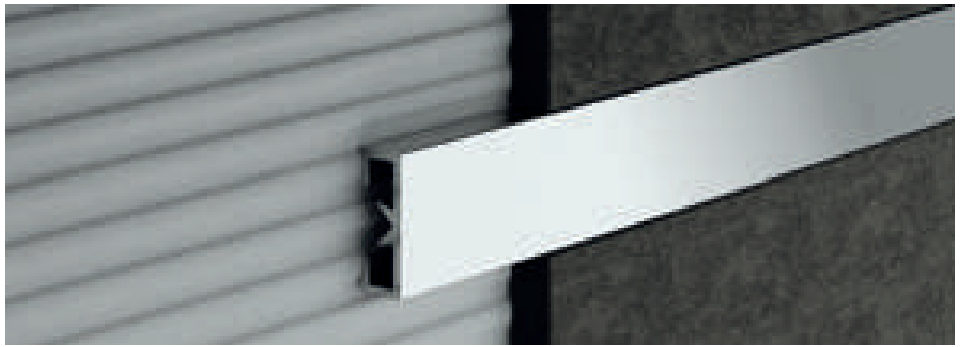

LDB/20 bright polished silver aluminium

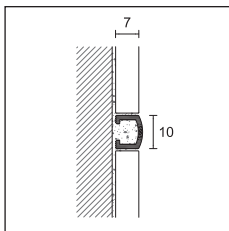
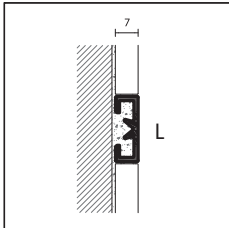

LB/B/10

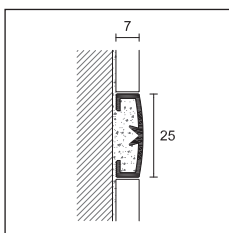

LB/A
LB/B/25

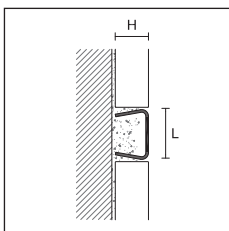

LA/I/
LA/IS/

Complete the article code with L measure (for example LDA/ for L=10 becomes LDA/10)

Stainless steel listellos: different measures on demand - minimum 108 meters

For a single piece, see sales conditions on page 288

PROLIST

length = 270 cm - pack 20 pcs

| | | L x H | | | |
|--------------------------------|--------------------------|--------------|--------------|--------------|--------------|
| ART. | finishing | 10x7 | 15x7 | 20x7 | 25x7 |
| ALUMINIUM | | | | | |
| LDA/ | silver anodised | 93255 | 93215 | 93220 | 93256 |
| | <i>euro/m</i> | 4,35 | 6,11 | 6,65 | 7,07 |
| LDB/ | bright polished silver | 93258 | 93219 | 93224 | 93259 |
| LDT/ | bright polished titanium | 93257 | 93218 | 93223 | 93268 |
| | <i>euro/m</i> | 6,14 | 8,05 | 8,45 | 8,86 |
| LDS/ | bright satin silver | 93240 | 93216 | 93221 | 93244 |
| | bright satin gold | 93241 | 93217 | 93222 | 93245 |
| LDTM/ | bright satin titanium | 93266 | 93211 | 93225 | 93246 |
| LDRS/ | bright satin copper | 93242 | 93267 | 93229 | 93269 |
| | <i>euro/m</i> | 8,14 | 9,96 | 10,45 | 10,88 |
| LDAG/ | bright scratched silver | 93263 | 93214 | 93228 | 93243 |
| | <i>euro/m</i> | 10,07 | 11,91 | 12,35 | 12,77 |
| COLOUR-COATED ALUMINIUM | | | | | |
| LDV/ | white stone | - | - | 93207 | - |
| | black stone | - | - | 93209 | - |
| | <i>euro/m</i> | - | - | 8,45 | - |

individually packed

PROLIST

length = 270 cm - pack 20 pcs

| | | L x H | |
|------------------|------------------------|-------------|-------------|
| ART. | finishing | 10x7 | 25x7 |
| ALUMINIUM | | | |
| LB/A | silver anodised | - | 93270 |
| | <i>euro/m</i> | - | 6,33 |
| LB/B/ | bright polished silver | 93252 | 93272 |
| | bright polished gold | 93253 | 93273 |
| | <i>euro/m</i> | 6,14 | 8,35 |

individually packed

PROLIST

length = 270 cm - pack 10 pcs

| | | L x H | | |
|------------------------|---|-------------|--------------|--------------|
| ART. | finishing | 10x10 | 15x10 | 25x10 |
| STAINLESS STEEL | | | | |
| LA/I/ | polished stainless steel AISI 304 DIN 1.4301 | 93283 | 93284 | 93285 |
| | <i>euro/m</i> | 6,64 | 9,92 | 14,68 |
| LA/IS/ | satin stainless steel AISI 304 DIN 1.4301 | 93296 | 93297 | 93298 |
| | <i>euro/m</i> | 8,34 | 11,63 | 16,39 |

individually packed

listellos and decorative profiles metal line AF - prolisT x design

Metal Line AF M Design is a decorative listello in aluminium characterized by modern and minimalist lines that, thanks to its special shape, creates an elegant shadow that crosses the ceramic covering.



AF/1/10 silver anodised aluminium

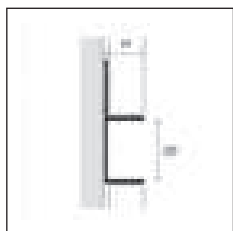

AF/1/



METAL LINE AF - M DESIGN

length = 270 cm - pack 10 pcs

| ART. | finishing | 6 | 10 | 12,5 | |
|------------------|---------------------------------------|---|--------------|--------------|--------------|
| ALUMINIUM | | | | | |
| | silver anodised | | 13198 | 13199 | 13200 |
| | <i>euro/m</i> | | 8,34 | 8,34 | 8,34 |
| AF/1/ | titanium anodised | | 13201 | 13203 | 13202 |
| | colour-coated polished white RAL 9010 | | 13196 | 13197 | 13204 |
| | <i>euro/m</i> | | 12,16 | 12,16 | 12,16 |

individually packed

Complete the article code with H measure (for example AF/1/ for H=10 becomes AF/1/10)

For a single piece, see sales conditions on page 288

ProlisT is available in five original finishes X Design. In anodised aluminium, X Design is characterized by a special scratched finish and original colours that allow different chromatic combinations, created for interior designers and architects by following the latest trends of modern design.



LDAD carbon anodised aluminium

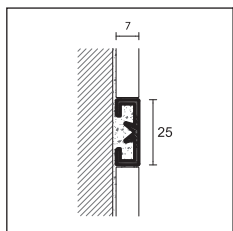

LDAD



PROLIST - X DESIGN

length = 270 cm - pack 10 pcs

| ART. | finishing | 25x7 | |
|---------------------------|---------------|------|--------------|
| ANODISED ALUMINIUM | | | |
| | platinum | | 31320 |
| | titanium | | 31322 |
| LDAD | brown | | 31324 |
| | dark brown | | 31326 |
| | carbon | | 31328 |
| | <i>euro/m</i> | | 13,38 |

individually packed



LED-light decorative listellos on page 232



cerfix® C design

C Design is a line of profiles, embellished with crystals from Swarovski®. The combination of the chromium plated or gold plated profile and the crystal enhances the brightness of the lines and makes elegant any space.

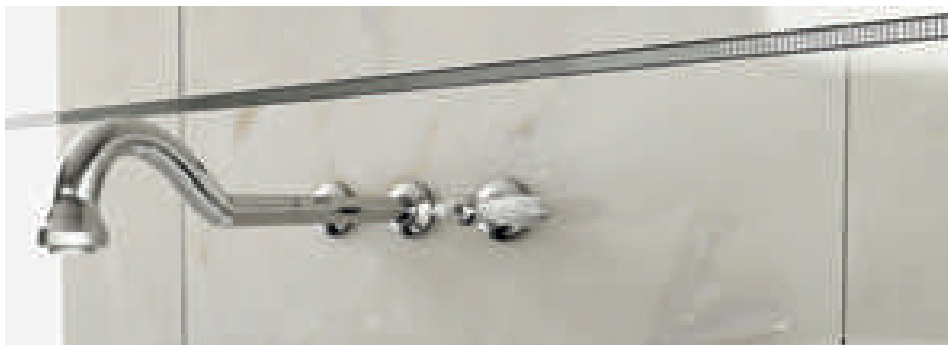

UKC/10 chromium-plated brass with crystals from Swarovski®



PRODECOR - C DESIGN

length = 270 cm - pack 5 pcs

H

ART. finishing

10

CHROMIUM-PLATED BRASS

| | | | |
|---------|--|--|---------------|
| | chromium-plated + crystals from Swarovski® | | 13300 |
| | <i>euro/m</i> | | 86,63 |
| DJKC/10 | chromium-plated + crystals from Swarovski® | | 13302 |
| | <i>euro/m</i> | | 148,73 |

individually packed

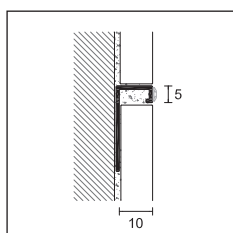

DJKC/10



DJKC/10 chromium-plated brass with crystals from Swarovski® (cod. 13300)



DJKC/10 chromium-plated brass with crystals from Swarovski® (cod. 13302)

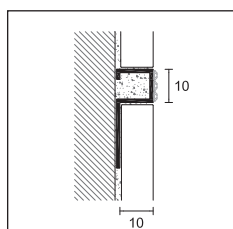

UKC/10

PROSTYLE - C DESIGN

length = 270 cm - pack 5 pcs

H

ART. finishing

10

CHROMIUM-PLATED BRASS

| | | | |
|--|--|--|---------------|
| | chromium-plated + crystals from Swarovski® | | 13310 |
| | <i>euro/m</i> | | 283,59 |

individually packed

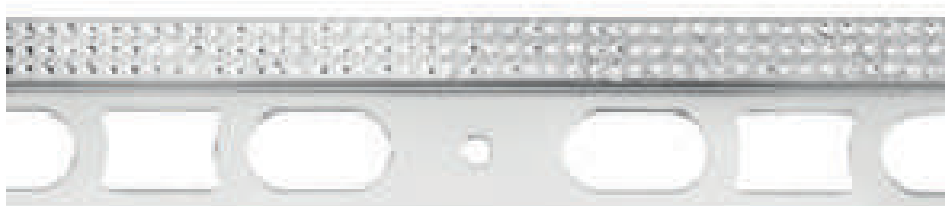

UKC/10 chromium-plated brass with crystals from Swarovski®

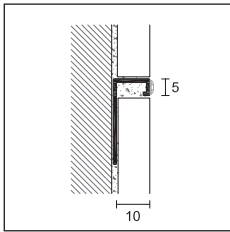

DJKGC/10

PRODECOR - C DESIGN

| | | |
|------------------------------|--|---------------|
| length = 270 cm - pack 5 pcs | | H |
| ART. | finishing | 10 |
| BRASS | | |
| DJKGC/10 | 24 kt gold plated + crystals from Swarovski® | 13402 |
| | <i>euro/m</i> | 195,41 |

individually packed

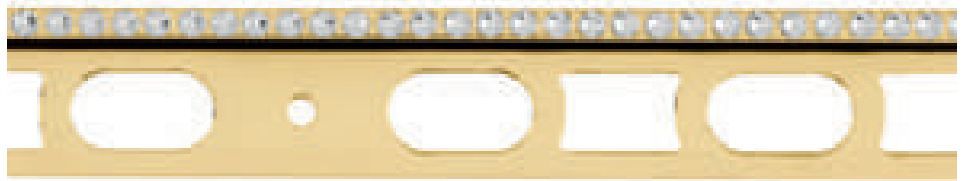

DJKGC/10 24 kt gold plated brass + crystals from Swarovski®

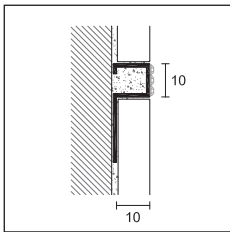

UKGC/10

PROSTYLE - C DESIGN

| | | |
|------------------------------|--|---------------|
| length = 270 cm - pack 5 pcs | | H |
| ART. | finishing | 10 |
| BRASS | | |
| UKGC/10 | 24 kt gold plated + crystals from Swarovski® | 13410 |
| | <i>euro/m</i> | 348,12 |

individually packed

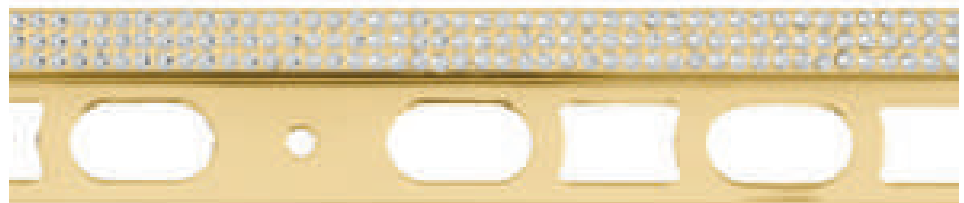

UKGC/10 24 kt gold plated brass + crystals from Swarovski®

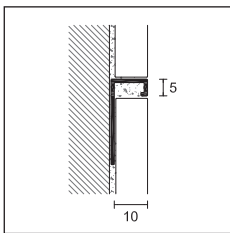

DJKG/10

PRODECOR - C DESIGN

| | | |
|------------------------------|------------------|--------------|
| length = 270 cm - pack 5 pcs | | H |
| ART. | finishing | 10 |
| BRASS | | |
| DJKG/10 | 24kt gold plated | 12902 |
| | <i>euro/m</i> | 61,95 |

individually packed

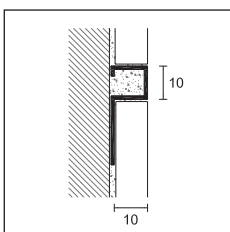

UKG/10

PROSTYLE - C DESIGN

| | | |
|------------------------------|------------------|--------------|
| length = 270 cm - pack 5 pcs | | H |
| ART. | finishing | 10 |
| BRASS | | |
| UKG/10 | 24kt gold plated | 12910 |
| | <i>euro/m</i> | 69,30 |

individually packed





internal corners profiles

A line of profiles that fits the perimetric junction between floor and wall. Created for the elimination of 90° corners and applicable to installed or to be installed floors, ensure high hygienic efficiency in private and public environments such as hospitals, food industries, SPA, swimming pools and industrial kitchens.

internal corners profiles

cerfix® proround

Proround M in aluminum is a connection profile between floor and wall. The current requirements for sanitary maintenance required by European standards, provide in fact the elimination of the 90° to avoid any deposit of dirty and possible sources of bacteria, creating a curvature to facilitate cleaning.



GA/10 silver anodised aluminium

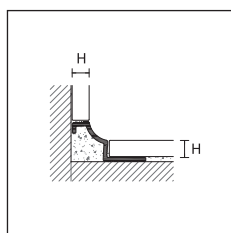

GA/4

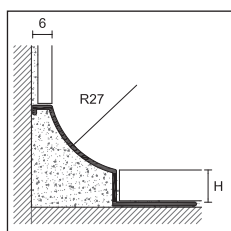

GA/8-10-12
GV/

Complete the article code with H measure (for example GA/ for H=8 becomes GA/8)

Items GV available in different colours on demand - minimum quantity 540 meters per colour.

For a single piece, see sales conditions on page 288

PROROUND M

length = 270 cm - pack 10 pcs

| | | H | | | |
|------------------|------------------------------|-------|-------|-------|-------|
| ART. | finishing | 4,5 | 8 | 10 | 12 |
| ALUMINIUM | | | | | |
| GA/ | silver anodised | 95730 | 95031 | 95032 | 95033 |
| | euro/m | 7,36 | 10,03 | 10,14 | 10,28 |
| GV/ | colour-coated white RAL 9003 | - | 95071 | 95072 | 95073 |
| | euro/m | - | 11,82 | 11,96 | 12,09 |

individually packed- GA/4 packaging 20 pcs

OUTSIDE CORNER

pack 5 pcs

| | | H | |
|------------------|------------------------------|-----|-------------|
| ART. | finishing | 4,5 | 8 - 10 - 12 |
| ALUMINIUM | | | |
| GTA/E | silver anodised | - | 95075 |
| | euro/pc | - | 9,94 |
| GTV/E | colour-coated white RAL 9003 | - | 95083 |
| | euro/pc | - | 9,98 |

INSIDE CORNER

pack 5 pcs

| | | H | |
|------------------|------------------------------|-----|-------------|
| ART. | finishing | 4,5 | 8 - 10 - 12 |
| ALUMINIUM | | | |
| GTA/I | silver anodised | - | 95077 |
| | euro/pc | - | 9,94 |
| GTV/I | colour-coated white RAL 9003 | - | 95085 |
| | euro/pc | - | 9,98 |

no partial packaging



GTA/E silver anodised aluminium



GTA/I silver anodised aluminium



GA/4 silver anodised aluminium

Proround M GAN/ is a profile in aluminum for the connection between floor and wall, characterized by a 17-mm radius.

GVNH/ boasts the certified antibacterial technology (according to the internationally recognized laboratory test JIS Z 2801:2000) which reduces the presence of the most dangerous bacteria up to 99%, thus assuring the best hygiene over time.



GAN/10 silver anodised aluminium

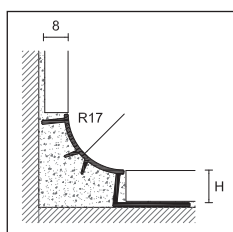

GAN/
GVNH/

NEW PROROUND M

| length = 270 cm - pack 10 pcs | | H | | |
|-------------------------------|--|-------------|--------------|--------------|
| ART. | finishing | 8 | 10 | 12,5 |
| ALUMINIUM | | | | |
| GAN/ | silver anodised | 95034 | 95035 | 95036 |
| | <i>euro/m</i> | 8,15 | 8,27 | 8,41 |
| GVNH/ | colour-coated white RAL 9003 antibacterial | 95037 | 95038 | 95039 |
| | <i>euro/m</i> | 9,93 | 10,05 | 10,19 |

individually packed

OUTSIDE/INSIDE/TRIAXIAL CORNER/END CAP

| pack 12 pcs | | for all H | | | |
|----------------------|------------------------------|-------------|-------------|-------------|-------------|
| ART. | finishing | GTP/E | GTP/I | GTP/T | GTP/C |
| POLYPROPYLENE | | | | | |
| | colour-coated silver | 95121 | 95122 | 95123 | 95124 |
| | <i>euro/pc</i> | 5,22 | 5,22 | 5,22 | 5,22 |
| | colour-coated white RAL 9003 | 95125 | 95126 | 95127 | 95128 |
| | <i>euro/pc</i> | 5,22 | 5,22 | 5,22 | 5,22 |

no partial packaging

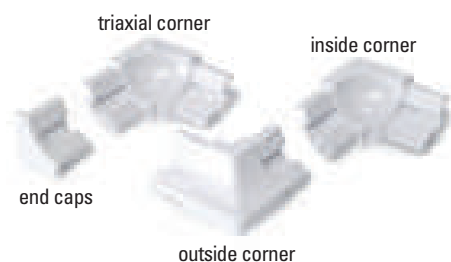

GTP/E silver colour-coated polypropylene

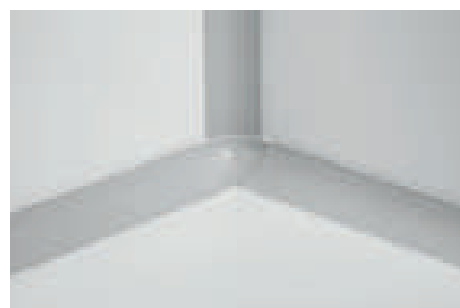

GTP/T silver colour-coated polypropylene

internal corners profiles

cerfix® proround

Stainless steel Proround M is a connection profile to be used in situations that require a particular level of sanitary protection (eg, medical, food industry, swimming pools, spas, industrial kitchens, hospitals, etc.). Specifically, the version in quality AISI 316 DIN 1.4404 offers characteristics of superior resistance to corrosion and is therefore recommended for use in areas subjected to higher chemical attacks, and sea zones.



GIN/10 + ILN/10 polished stainless steel AISI 304 DIN 1.4301

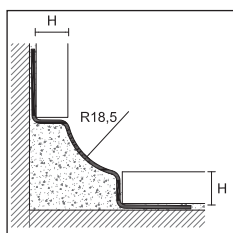

GIN 8/10/11

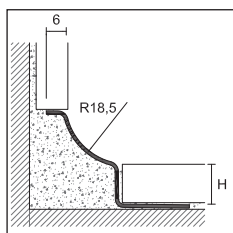

GIN/SA

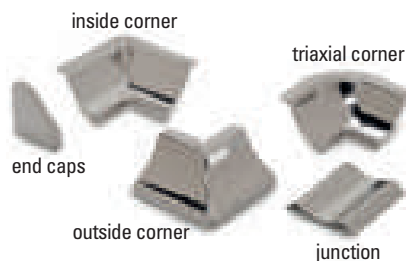

PROROUND M

length = 270 cm - pack 10 pcs

| | | H | | | | |
|------------------------|---|-------|-------|-------|------|----|
| ART. | finishing | 8 | 10 | 11 | 12,5 | 15 |
| STAINLESS STEEL | | | | | | |
| GIN/ | polished stainless steel AISI 304 DIN 1.4301 | 95046 | 95047 | 95045 | - | - |
| | euro/m | 17,87 | 18,25 | 18,44 | - | - |
| GINS/ | satin stainless steel AISI 304 DIN 1.4301 | 95050 | 95051 | 95057 | - | - |
| | euro/m | 21,06 | 21,47 | 21,67 | - | - |
| GINX/ | stainless steel AISI 316 DIN 1.4404 | 95054 | 95055 | - | - | - |
| | euro/m | 21,60 | 21,99 | - | - | - |

individually packed

PROROUND M

length = 270 cm - pack 10 pcs

| | | H | | | | |
|------------------------|---|---|-----------|----|-------|-------|
| ART. | finishing | 8 | 10 | 11 | 12,5 | 15 |
| STAINLESS STEEL | | | | | | |
| GIN/SA | polished stainless steel AISI 304 DIN 1.4301 | - | NEW 95044 | - | 95048 | 95049 |
| | euro/m | - | 14,18 | - | 18,64 | 19,29 |
| GINS/SA | satin stainless steel AISI 304 DIN 1.4301 | - | - | - | 95052 | - |
| | euro/m | - | - | - | 21,86 | - |
| GINX/SA | stainless steel AISI 316 DIN 1.4404 | - | - | - | 95056 | - |
| | euro/m | - | - | - | 22,47 | - |

individually packed

OUTSIDE CORNER-E

pack 5 pcs

| | | for all H | | INSIDE CORNER-I | |
|------------------------|---|-----------|--|-----------------|-------|
| ART. | finishing | | | ART. | |
| STAINLESS STEEL | | | | | |
| GTIN/E | polished stainless steel AISI 304 DIN 1.4301 | 95059 | | GTIN/I | 95058 |
| | euro/pc | 7,14 | | | 7,14 |
| GTINS/E | satin stainless steel AISI 304 DIN 1.4301 | 95063 | | GTINS/I | 95062 |
| | euro/pc | 9,56 | | | 9,56 |
| GTINX/E | stainless steel AISI 316 DIN 1.4404 | 95067 | | GTINX/I | 95066 |
| | euro/pc | 7,98 | | | 7,98 |

TRIAXIAL CORNER-T

pack 5 pcs

| | | for all H | | JUNCTION-G | | END CAPS | |
|---------|---|-----------|--|------------|-------|----------|-------|
| ART. | finishing | | | ART. | | ART. | |
| GTIN/T | polished stainless steel AISI 304 DIN 1.4301 | 95060 | | GTIN/G | 95061 | GTIN/C | 95040 |
| | euro/pc | 7,14 | | | 7,14 | | 7,14 |
| GTINS/T | satin stainless steel AISI 304 DIN 1.4301 | 95064 | | GTINS/G | 95065 | GTINS/C | 95041 |
| | euro/pc | 9,56 | | | 9,56 | | 9,56 |
| GTINX/T | stainless steel AISI 316 DIN 1.4404 | 95068 | | GTINX/G | 95069 | GTINX/C | 95042 |
| | euro/pc | 7,98 | | | 7,98 | | 7,98 |

no partial packaging

Complete the article code with H measure (for example GIN/ for H=8 becomes GIN/8)

Cerfix® Proround M in stainless steel:
other measures on demand - minimum quantity 540 meters

For a single piece, see sales conditions on page 288

Proround P in non-toxic PVC and impact resistant is a connection profile between floor and wall. The current requirements for sanitary maintenance required by European standards, provide in fact the elimination of the 90 ° to avoid any deposit of dirty and possible sources of bacteria, creating a curvature to facilitate cleaning. Models with a single anchor flange allow to be used as a connection between the laying floors and walls with different thickness.



GP/10 white co-extruded PVC

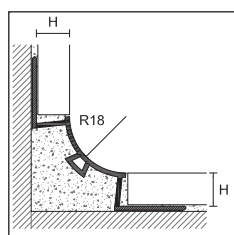

GP/

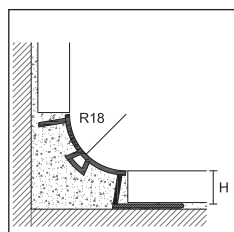

GPU/

PROROUND P

length = 270 cm - pack 20 pcs

| ART. | H | | H | |
|------------------------|----------|-------------|-------------|-------------|
| | GP/ | | GPU/ | |
| finishing | 8 | 10 | 10 | 12,5 |
| CO-EXTRUDED PVC | | | | |
| white | | 95800 | 95801 | 95804 |
| light grey RAL 7035 | | 95805 | 95806 | - |
| stone grey RAL 7030 | | 95810 | 95811 | - |
| beige grey RAL 1019 | | 95815 | 95816 | - |
| euro/m | | 3,99 | 4,19 | 4,15 |

INSIDE/OUTSIDE/TRIAXIAL CORNER/END CAP

pack 12 pcs

for all H

| ART. | GTP/E | GTP/I | GTP/T | GTP/C |
|----------------------|-------|-------------|-------------|-------------|
| finishing | | | | |
| POLYPROPYLENE | | | | |
| white | | 95852 | 95851 | 95850 |
| light grey RAL 7035 | | 95862 | 95861 | 95860 |
| stone grey RAL 7030 | | 95872 | 95871 | 95870 |
| beige grey RAL 1019 | | 95882 | 95881 | 95880 |
| euro/pc | | 2,26 | 2,26 | 2,26 |

no partial packaging

Complete the article code with H measure (for example GP/ for H=8 becomes GP/8)

For a single piece, see sales conditions on page 288

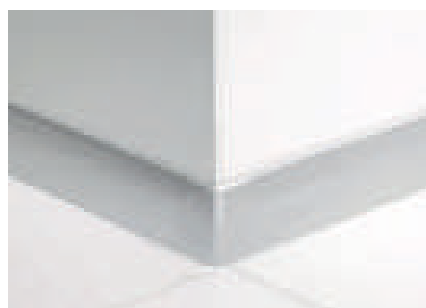

GTP/E RAL 7035 light grey polypropylene

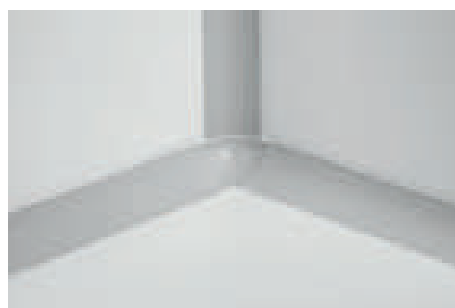

GTP/T RAL 7035 light grey polypropylene

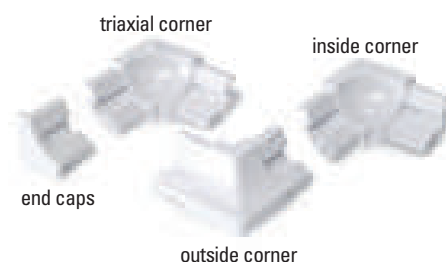

internal corners profiles

cerfix® proround

Proround M GIC/ and Proint PIN/ are two stainless steel profiles with rounded shape for the connection of floors and walls, to be used in those spaces where special hygiene protection is required.

The shape of GIC/ is particularly versatile thanks to the internal fixing flange.

The shape of PIN/ facilitates the corner connection of floors and walls, thus guaranteeing the expansion between the two surfaces.



GIC/8 polished stainless steel AISI 304 DIN 1.4301

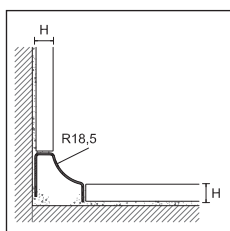

GIC/

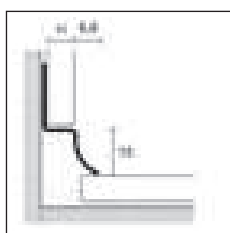
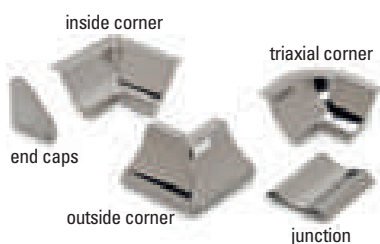

PIN/

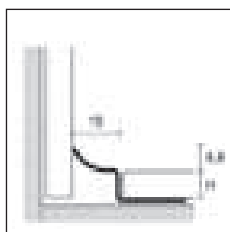

PIN/

Complete the article code with H measure (for example GIC/ for H=8 becomes GIC/8)

We can create profiles Cerfix Proround GIC/ with sizes on request, for floors and coverings of different thickness. Contact our technical department for more informations.

For a single piece, see sales conditions on page 288

PROROUND M

length = 270 cm - pack 5 pcs

| | | |
|------------------------|---|--------------|
| ART. | finishing | 8 |
| STAINLESS STEEL | | |
| GIC/ | polished stainless steel AISI 304 DIN 1.4301 | 95140 |
| | <i>euro/m</i> | 18,27 |

| OUTSIDE CORNER-E | | INSIDE CORNER-I | |
|------------------------|---|-----------------|---------------|
| pack 5 pcs | for all H | pack 5 pcs | for all H |
| ART. | finishing | ART. | |
| STAINLESS STEEL | | | |
| GTIN/E | polished stainless steel AISI 304 DIN 1.4301 | 95059 | GTIN/I |
| | <i>euro/pc</i> | 7,14 | 95058 |
| | | | 7,14 |

no partial packaging

| TRIAXIAL CORNER-T | | JUNCTION-G | END CAPS |
|------------------------|---|---------------|---------------|
| pack 5 pcs | for all H | pack 5 pcs | for all H |
| ART. | finishing | ART. | ART. |
| STAINLESS STEEL | | | |
| GTIN/T | polished stainless steel AISI 304 DIN 1.4301 | GTIN/G | 95061 |
| | <i>euro/pc</i> | 7,14 | GTIN/C |
| | | | 95040 |
| | | | 7,14 |

no partial packaging

PROINT

length = 270 cm - pack 10 pcs

| | | | | |
|------------------------|---|--------------|----------|--------------|
| ART. | finishing | 10 | H | 12,5 |
| STAINLESS STEEL | | | | |
| PIN/ | polished stainless steel AISI 304 - DIN 1.4301 | 85392 | | 85394 |
| | <i>euro/m</i> | 10,14 | | 10,52 |

individually packed



PIN/10 polished stainless steel AISI 304 DIN 1.4301

Proint PIA/ and PI/ are two line of profiles in aluminium and PVC, suitable as perimetral connection during the installation of the wall covering and the floor or as perimetral expansion joint.

The use of Proint PIA/ and PI/ allows to avoid the use of silicone for sealing and, in addition to the aesthetic advantage, it guarantees a high hygiene over time.

The special sections of Proint facilitate the corner connection between the wall covering and the floor, thus guaranteeing the expansion between the two surfaces.



PIA/9 silver anodised aluminium

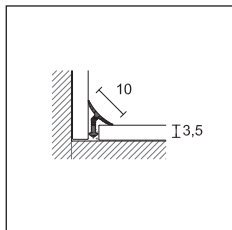

PIA/3

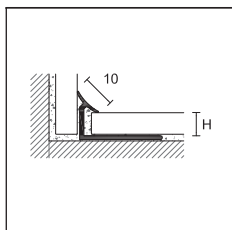

PIA/
PI/

PROINT

length = 270 cm - pack 20 pcs

| | | H | | | |
|------------------|-----------------|-------|-------|-------|-------|
| ART. | finishing | 3,5 | 7 | 9 | 12 |
| ALUMINIUM | | | | | |
| PIA/ | silver anodised | 95431 | 95430 | 95432 | 95429 |
| | euro/m | 4,99 | 6,16 | 6,46 | 7,02 |

individually packed

PROINT

length = 270 cm - pack 20 pcs

| | | H | |
|------------------------|----------------------|-------|-------|
| ART. | finishing | 7 | 9 |
| CO-EXTRUDED PVC | | | |
| PI/ | snow white | 95396 | 95398 |
| | white | 95400 | 95402 |
| | cream white RAL 9001 | - | 95406 |
| | ivory RAL 1015 | - | 95418 |
| | beige grey RAL 1019 | - | 95410 |
| | stone grey RAL 7030 | - | 95422 |
| | ash grey RAL 7038 | - | 95433 |
| | light grey RAL 7035 | - | 95414 |

| | | |
|--------------------|------|------|
| pack 20 pcs | | |
| euro/m | 1,28 | 1,39 |

| | | |
|---------------------|------|------|
| pack 100 pcs | | |
| euro/m | 1,05 | 1,16 |

no partial packaging - to order the pack of 100 pcs, mark /100 after article code

Complete the article code with H measure (for example PIA/ for H=7 becomes PIA/7)

Items PI/ available in different colours on demand - minimum quantity 2700 meters per colour

For a single piece, see sales conditions on page 288



PI/9 white co-extruded PVC



PIA/3 silver anodised aluminium

cerfix® proround

Proround B in aluminium or PVC are perimetral connection profiles to be used between floors and walls, specially designed for the application on already-laid surfaces. These profiles are the best solution for renovations and to be compliant with hygienic regulations. BLAH/ boasts the certified antibacterial technology (according to the internationally recognized laboratory test JIS Z 2801:2000) which reduces the presence of the most dangerous bacteria up to 99%, thus assuring the best hygiene over time.



BLA/20 silver anodised aluminium

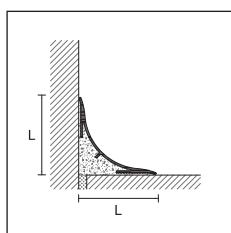

BLA/
BLAH/

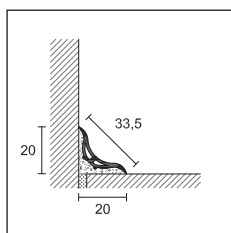

BL/20

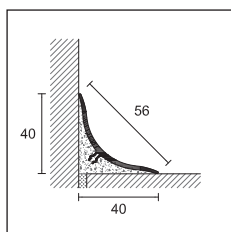

BL/40

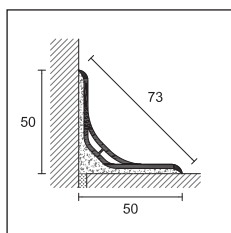

BL/50



polypropylene accessories

PROROUND B

length = 270 cm - pack 20 pcs

LxL

| ART. | finishing | | 20x20 | 40x40 | 50x50 |
|--|---|--|-------------|--------------|-------|
| ALUMINIUM | | | | | |
| BLA/ | silver anodised | | 95570 | 95580 | - |
| | <i>euro/m</i> | | 6,24 | 8,17 | - |
| ANTIBACTERIAL COLOUR-COATED ALUMINIUM | | | | | |
| BLAH/ | colour-coated white RAL 9003 antibacterial | | 95572 | 95582 | - |
| | <i>euro/m</i> | | 9,54 | 10,89 | - |

individually packed

PROROUND B

length = 270 cm - pack 20 pcs

LxL

| ART. | finishing | | 20x20 | 40x40 | 50x50 |
|------------|---------------|--|-------------|-------------|-------------|
| PVC | | | | | |
| BL/ | white | | 95550 | 95500 | 95551 |
| | <i>euro/m</i> | | 4,04 | 5,92 | 8,55 |

POLYPROPYLENE ACCESSORIES PACK

8 pcs

4 pcs

4 pcs

OUTSIDE CORNER IN POLYPROPYLENE

| | | | | | |
|----------------|----------------|--|-------------|-------------|-------------|
| GBL/ /E | silver | | 95574 | 95584 | - |
| | white | | 95556 | 95510 | 95552 |
| | <i>euro/pc</i> | | 3,09 | 4,10 | 4,35 |

INSIDE CORNER IN POLYPROPYLENE

| | | | | | |
|----------------|----------------|--|-------------|-------------|-------------|
| GBL/ /I | silver | | 95576 | 95586 | - |
| | white | | 95557 | 95512 | 95553 |
| | <i>euro/pc</i> | | 3,09 | 4,10 | 4,35 |

TRIAXIAL CORNER IN POLYPROPYLENE

| | | | | | |
|----------------|----------------|--|---|-------------|-------------|
| GBL/ /T | silver | | - | 95588 | - |
| | white | | - | 95511 | 95554 |
| | <i>euro/pc</i> | | - | 4,10 | 4,35 |

RIGHT-LEFT END CAPS IN POLYPROPYLENE

| | | | | | |
|----------------|----------------|--|-------------|-------------|-------------|
| GBL/ /C | silver | | 95578 | 95590 | - |
| | white | | 95558 | 95513 | 95555 |
| | <i>euro/pc</i> | | 3,09 | 3,92 | 4,14 |

no partial packaging - article GBL/ /C pack of 16 pcs (20x20) and 8 pcs (40x40 and 50x50)

Complete the article code with L measure (for example BLA/ for L= 20 becomes BLA/20)
For a single piece, see sales conditions on page 288

Proround B in stainless steel are perimetral connection profiles to be used between floors and walls, specially designed for the application on already-laid surfaces. These profiles are the best solution for renovations and to be compliant with hygienic regulations.

Stainless steel is particularly resistant to the attack of organic and inorganic agents and, therefore, it is suitable in spaces such as hospitals, food and chemical industries.



BI/40 stainless steel AISI 304 DIN 1.4301

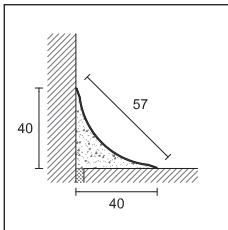

BI/40
BI/40/A

PROROUND B

| length = 270 cm - pack 20 pcs | | | LxL |
|-------------------------------|--|--|-----------------------|
| ART. | finishing | | 40x40 |
| STAINLESS STEEL | | | |
| BI/40 | stainless steel AISI 304 DIN 1.4301 | | 94992 14,10 |
| BI/40/A adhesive | stainless steel AISI 304 DIN 1.4301 | | 94993 17,47 |

POLYPROPYLENE MATCHING CHROMIUM FINISH PACK 4 PCS

OUTSIDE CORNER IN POLYPROPYLENE

| | | | |
|-------|----------------------------------|--|----------------------|
| GTL/E | polypropylene chromium effect | | 95515 5,99 |
|-------|----------------------------------|--|----------------------|

INSIDE CORNER IN POLYPROPYLENE

| | | | |
|-------|----------------------------------|--|----------------------|
| GTL/I | polypropylene chromium effect | | 95517 5,99 |
|-------|----------------------------------|--|----------------------|

TRIAXIAL CORNER IN POLYPROPYLENE

| | | | |
|-------|----------------------------------|--|----------------------|
| GTL/T | polypropylene chromium effect | | 95516 5,99 |
|-------|----------------------------------|--|----------------------|

RIGHT-LEFT END CAPS IN POLYPROPYLENE

| | | | |
|-------|----------------------------------|--|----------------------|
| GTL/C | polypropylene chromium effect | | 95518 5,99 |
|-------|----------------------------------|--|----------------------|

no partial packaging



For a single piece, see sales conditions on page 288



linear shower drains and systems for bathrooms

Profilpas offers a wide range of solutions for bathrooms which combine functionality and modern design. In particular, Profilpas bathroom systems allow the creation of floor-level showers, with a wide selection of linear shower drains - like PP Drain Aqua, Thin Drain, Slim Drain and Smart Drain, all customizable with different grates - and Q-Drain, available in several models. Profilpas bathroom range also includes Glass Profile, a line of profiles for the insertion of glass walls and the finishing of the shower surface, designed to compensate the 2% slope.



PP Drain Aqua

PPdrain | Aqua

The linear shower drains PP Drain Aqua, made of stainless steel AISI 316 and provided with a patented removable siphon in antibacterial ABS, are a perfect synthesis of beauty and practicality. Profilpas has taken care of every aspect of their design, production and quality control, to offer a product that is always efficient and aesthetically perfect.

The linear shower drains PP Drain Aqua, composed of a single piece without welds, distinguish for their design and functionality that make them elegant, simple to install and easy to clean. Each part of the shower drain is studied in detail, to contain in few components all that is needed to guarantee the maximum ease of installation and maintenance.

Aesthetics



Elegant and exclusive design, customisable with a wide range of covers and finishes.

Removable siphon

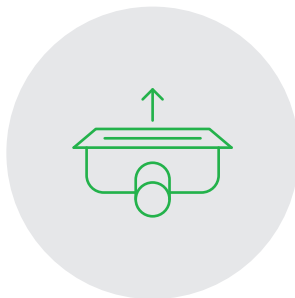

The siphon is simple to remove and can be easily inspected, for the maximum efficiency.

Ease of installation



The assembly and the adjustment of the shower drain are simplified, for a simple and quick installation.

Cleanliness and hygiene



The removable siphon in antibacterial ABS simplifies the maintenance and allows a quick and efficient cleanliness.



PP Drain Aqua

The essentiality of the linear shape of the shower drain, combined to the beauty of the multiple finishes, allows to offer an aesthetically perfect solution, able to adapt to any kind of design and to any material (porcelain stoneware, marble, mosaic, natural stone...).

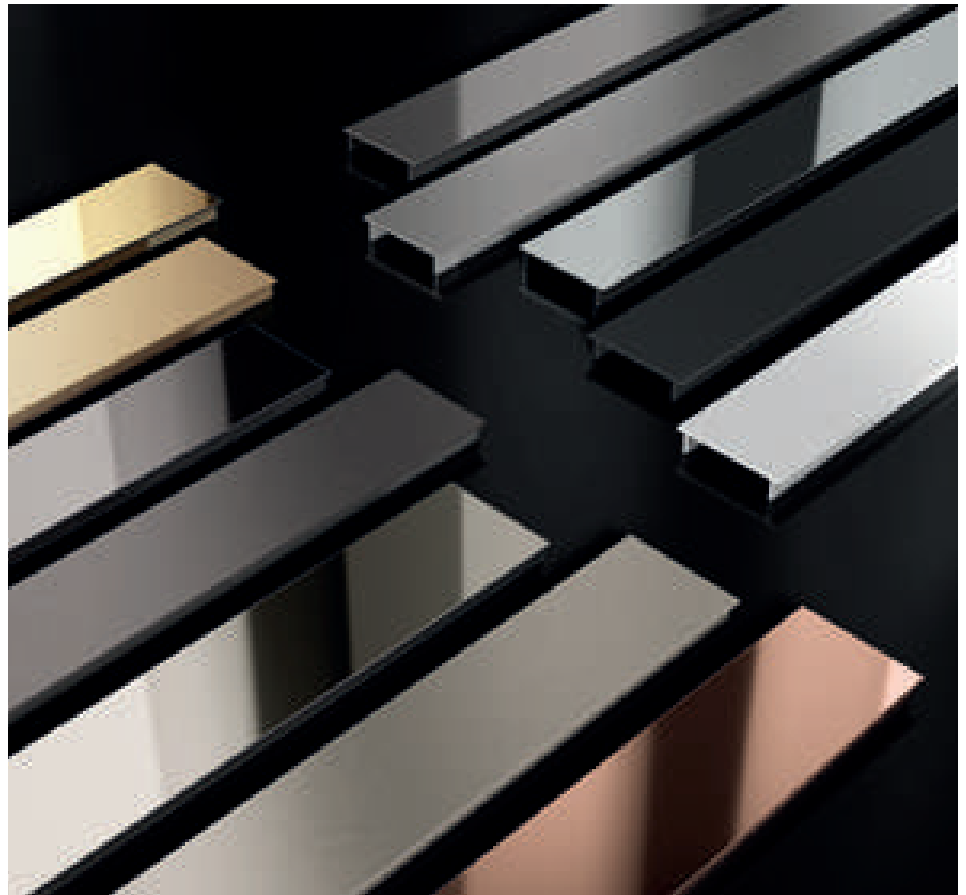

PP Drain Aqua

With PP Drain Aqua linear shower drains, maintenance and cleaning are fully simplified. The siphon, made of antibacterial ABS, can be removed and inspected completely. Furthermore, the AISI 316 stainless steel shower drain base is composed of a single piece without welds and sharp edges for the best hygiene and efficiency. Studied to minimize installation times, they are equipped with a pre-glued waterproofing membrane, supports from 6 to 18 mm for the height adjustment of the covers and bases in polystyrene foam.

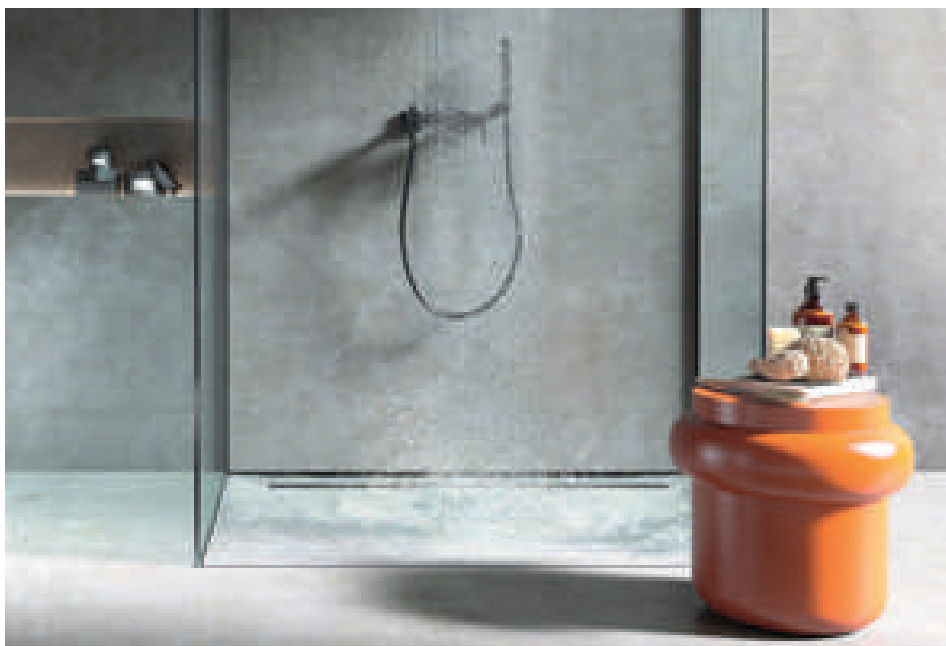

PP Drain Aqua

NEW PP DRAIN AQUA - shower drain base with siphon

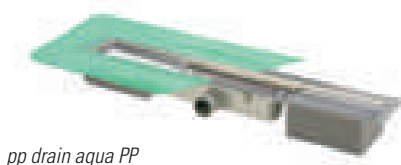

pp drain aqua PP

| ART. | finishing | | L | | | | | |
|------------------------|---------------------|--|--------|--------|--------|--------|--------|--------|
| | | | 60 cm | 70 cm | 80 cm | 90 cm | 100 cm | 120 cm |
| STAINLESS STEEL | | | | | | | | |
| PP/ | stainless steel | | 22100 | 22101 | 22102 | 22103 | 22104 | 22105 |
| | AISI 316 DIN 1.4404 | | | | | | | |
| | euro/pc | | 150,92 | 158,40 | 171,05 | 178,53 | 189,09 | 204,05 |

NEW PP DRAIN AQUA - shower drain base with direct drainage diam. 50 mm

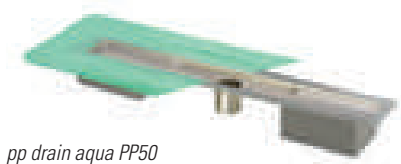

pp drain aqua PP50

| ART. | finishing | | L | | | | | |
|------------------------|---------------------|--|--------|--------|--------|--------|--------|--------|
| | | | 60 cm | 70 cm | 80 cm | 90 cm | 100 cm | 120 cm |
| STAINLESS STEEL | | | | | | | | |
| PP50/ | stainless steel | | 22106 | 22107 | 22108 | 22109 | 22110 | 22111 |
| | AISI 316 DIN 1.4404 | | | | | | | |
| | euro/pc | | 115,17 | 122,54 | 135,30 | 142,67 | 153,34 | 168,30 |

Shower drain base with direct drainage diam. 40 mm available upon request.

cover¹

frame²

ABS supports

hair catcher filter

removable top in antibacterial ABS

removable siphon in antibacterial ABS

waterproofing membrane

single-piece base in stainless steel AISI 316

base in polystyrene

drain in antibacterial ABS

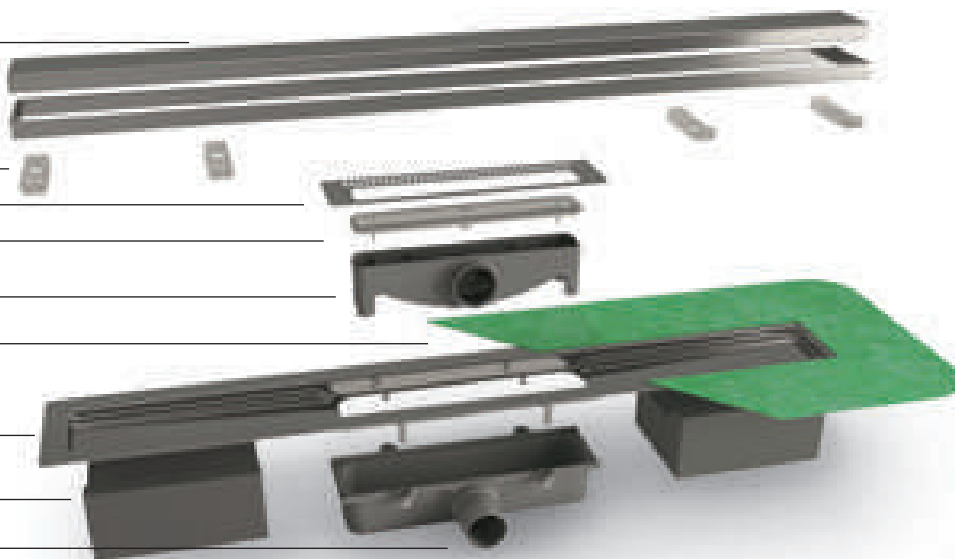

¹ Different types of cover available.

² The frame is present in Classic Cover model. The other covers are not equipped with frame.

Complete the article code with L measure (for example PP/ for L = 70 becomes PP/70)

PP Drain Aqua

Classic Cover, in polished or satin stainless steel AISI 316, is available in different lengths (from 60 to 120 cm). It includes the frame and the adjustment supports from 6 to 18 mm, and it is reversible: if turned upside down, it becomes tileable (up to 12 mm), thus creating aesthetic continuity with the bathroom covering.

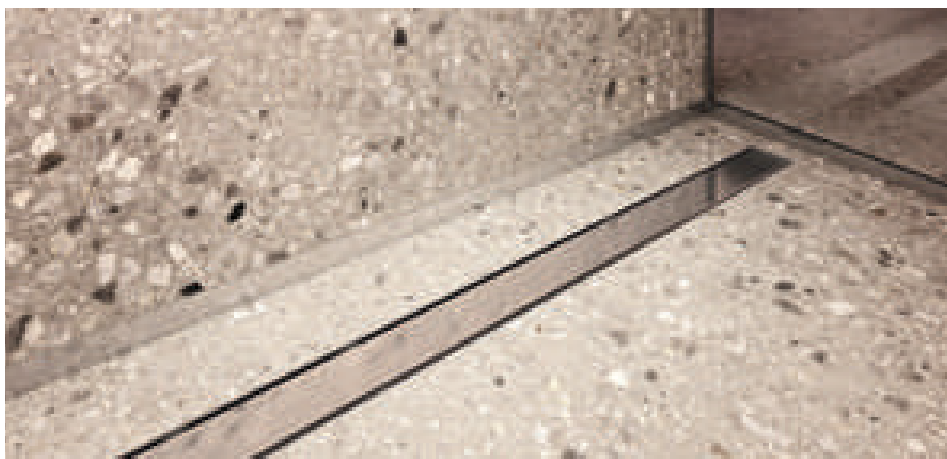

PP Drain Aqua - Classic Cover polished stainless steel AISI 316 - DIN 1.4404

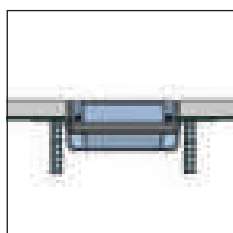

Classic Cover

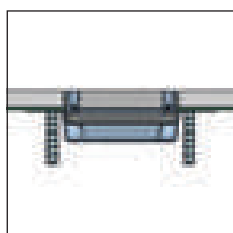



Classic Cover tileable



Classic Cover satin stainless steel AISI 316 DIN 1.4404

NEW CLASSIC COVER - tiles thickness from 6 to 18 mm

| ART. | finishing | L | | | | | | |
|------------------------|--|---|--------------|--------------|---------------|---------------|---------------|---------------|
| | | 60 cm | 70 cm | 80 cm | 90 cm | 100 cm | 120 cm | |
| STAINLESS STEEL | | | | | | | | |
| XPC/ | polished stainless steel AISI 316 DIN 1.4404 |  | 22112 | 22113 | 22114 | 22115 | 22116 | 22117 |
| | satin stainless steel AISI 316 DIN 1.4404 |  | 22118 | 22119 | 22120 | 22121 | 22122 | 22123 |
| | <i>euro/pc</i> | | 91,08 | 98,89 | 108,35 | 127,05 | 134,20 | 150,15 |

Classic Cover is reversible, if turned upside down it becomes tileable (with a thickness up to 12 mm).



PP Drain Aqua - Classic Cover satin stainless steel AISI 316 - DIN 1.4404

Complete the article code with L measure (for example XPC/ for L = 70 becomes XPC/70)

PP Drain Aqua

Flat Cover, available in several finishes and different lengths (from 60 to 120 cm), stands out for the perfectly flat and linear design. It is provided with adjustment supports that allow it to be adapted to tiles with thickness from 6 to 18 mm.

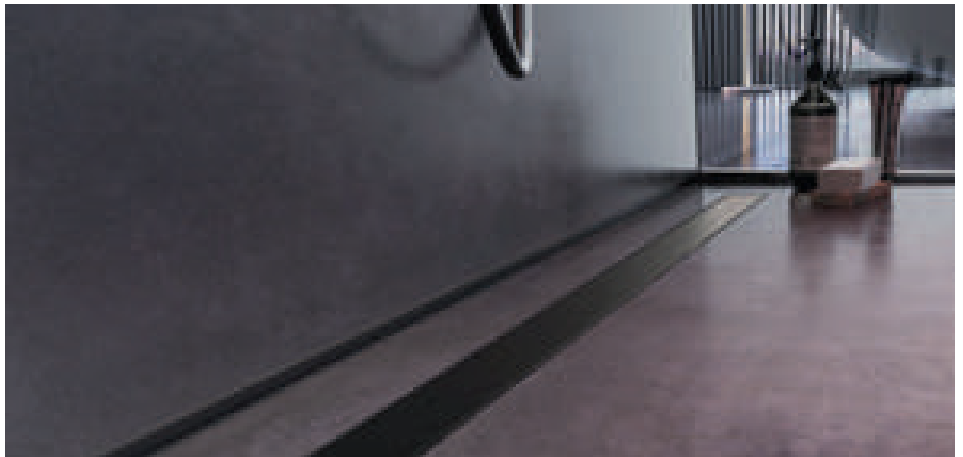

PP Drain Aqua - Flat Cover matt black colour-coated aluminium

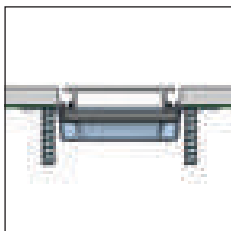

Flat Cover aluminium

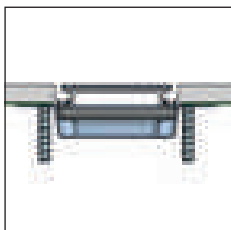













Flat Cover aluminium + stainless steel



Flat Cover chromium-plated stainless steel

NEW FLAT COVER - tiles thickness from 6 to 18 mm

| ART. | finishing | L | | | | | | |
|--|--|---|--------|--------|--------|--------|--------|--------|
| | | 60 cm | 70 cm | 80 cm | 90 cm | 100 cm | 120 cm | |
| ALUMINIUM + STAINLESS STEEL | | | | | | | | |
| XPF/ | polished stainless steel AISI 316 DIN 1.4404 |  | 22136 | 22137 | 22138 | 22139 | 22140 | 22141 |
| | satin stainless steel AISI 316 DIN 1.4404 |  | 22142 | 22143 | 22144 | 22145 | 22146 | 22147 |
| | <i>euro/pc</i> | | 57,97 | 63,36 | 69,41 | 82,39 | 90,09 | 101,31 |
| ALUMINIUM + CHROMIUM-PLATED STAINLESS STEEL | | | | | | | | |
| XPF/ | chromium-plated stainless steel AISI 316 DIN 1.4404 |  | 22261 | 22262 | 22263 | 22264 | 22265 | - |
| | <i>euro/pc</i> | | 90,64 | 96,03 | 112,97 | 125,95 | 125,95 | - |
| COLOUR-COATED ALUMINIUM | | | | | | | | |
| XPF/ | matt white |  | 22148 | 22149 | 22150 | 22151 | 22152 | - |
| | matt black |  | 22154 | 22155 | 22156 | 22157 | 22158 | - |
| | <i>euro/pc</i> | | 49,39 | 51,48 | 53,57 | 62,37 | 64,57 | - |
| ALUMINIUM + STAINLESS STEEL | | | | | | | | |
| XPF/ | polished nickel |  | 22226 | 22227 | 22228 | 22229 | 22230 | - |
| | satin nickel |  | 22231 | 22232 | 22233 | 22234 | 22235 | - |
| | polished pink gold |  | 22236 | 22237 | 22238 | 22239 | 22240 | - |
| | <i>euro/pc</i> | | 161,48 | 166,76 | 172,81 | 185,90 | 193,49 | - |
| | polished graphite |  | 22241 | 22242 | 22243 | 22244 | 22245 | - |
| | satin graphite |  | 22246 | 22247 | 22248 | 22249 | 22250 | - |
| | <i>euro/pc</i> | | 172,37 | 177,65 | 183,70 | 196,79 | 204,38 | - |
| | polished gold |  | 22251 | 22252 | 22253 | 22254 | 22255 | - |
| | satin gold |  | 22256 | 22257 | 22258 | 22259 | 22260 | - |
| | <i>euro/pc</i> | | 253,99 | 259,38 | 265,43 | 278,41 | 286,11 | - |



Flat Cover

Complete the article code with L measure
(for example XPF/ for L = 70 becomes XPF/70)

PP Drain Aqua

Design Cover stands out for the absolute elegance of its design and for the central drain. In polished or satin stainless steel AISI 316, it is available in different lengths, from 60 to 120 cm.



PP Drain Aqua - Design Cover satin stainless steel AISI 316 DIN 1.4404

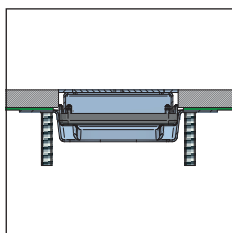



Design Cover



Design Cover

NEW DESIGN COVER - tiles thickness from 6 to 18 mm

| ART. | finishing | L | | | | | | |
|------------------------|---|---|--------------|--------------|---------------|---------------|---------------|---------------|
| | | 60 cm | 70 cm | 80 cm | 90 cm | 100 cm | 120 cm | |
| STAINLESS STEEL | | | | | | | | |
| XPD/ | polished stainless steel AISI 316 DIN 1.4404 |  | 22214 | 22215 | 22216 | 22217 | 22218 | 22219 |
| | satin stainless steel AISI 316 DIN 1.4404 |  | 22220 | 22221 | 22222 | 22223 | 22224 | 22225 |
| | euro/pc | | 86,46 | 94,27 | 103,84 | 118,69 | 126,94 | 149,60 |

With Invisible Cover, the shower tray and the linear shower drain become as one and blend perfectly with the bathroom covering. In natural aluminium and different lengths (from 60 to 120 cm), it disappears under the tile for a completely invisible aesthetic effect.



PP Drain Aqua - Invisible Cover

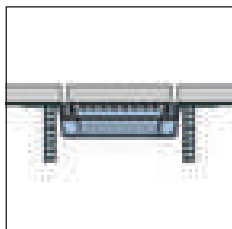

Invisible Cover



Invisible Cover

NEW INVISIBLE COVER

| ART. | finishing | L | | | | | | |
|------------------|-------------------|---|--------------|--------------|--------------|--------------|--------------|--------------|
| | | 60 cm | 70 cm | 80 cm | 90 cm | 100 cm | 120 cm | |
| ALUMINIUM | | | | | | | | |
| XPI/ | natural aluminium |  | 22130 | 22131 | 22132 | 22133 | 22134 | 22135 |
| | euro/pc | | 27,94 | 29,81 | 31,79 | 39,16 | 41,14 | 44,99 |

Complete the article code with L measure
(for example XPD/ for L = 70 becomes XPD/70)

thin drain

thindrain



Thin Drain is a line of flush with the floor shower drains for a quick and easy installation, which allows to customize the shower with any kind of covering. Thanks to the syphon with low thickness and the height of the shower drain of just 55 mm, they are particularly suitable for refurbishments or in spaces where lightness and versatility are the main features.

ADVANTAGES

- Installation flush with the floor (it eliminates architectural barriers)
- Possibility of installation close to the wall
- Height of the shower drain of 55 mm (laying surface)
- Suitable for tiles with thickness up to 12 mm
- Possibility of laying tiles with thickness up to 12 mm with Tile Cover
- Shower drains with certification EN 1253-1 (minimum flow rate of 24 l/ min)
- Supports for quick installation
- Integrated waterproof membrane to reduce the risk of seepages
- Possibility of inspection of the syphon for periodic cleaning
- Filter for cleaning/hair
- Quick installation
- Drain adapter from 4 to 50 mm included



classic cover - polished stainless steel AISI 304 - DIN 1.4301



classic cover - satin stainless steel AISI 304 - DIN 1.4301

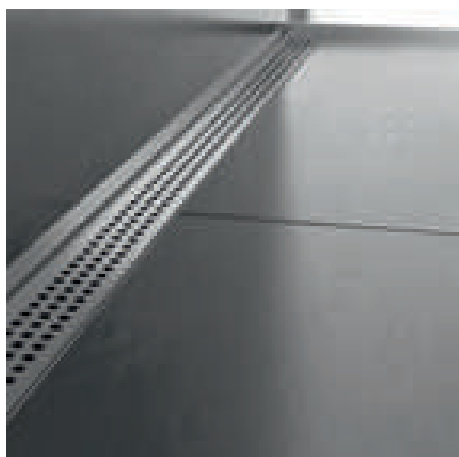

cube cover - satin stainless steel AISI 304 - DIN 1.4301

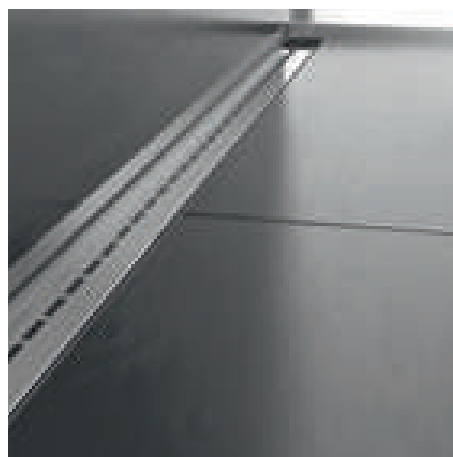



single line cover - polished stainless steel AISI 304 - DIN 1.4301

THIN DRAIN - BASE - pack 10 pcs

| ART. | finishing | | 60 cm | 70 cm | 80 cm | 90 cm | 100 cm | 120 cm |
|------------------------|--|---|--------|--------|--------|--------|--------|--------|
| STAINLESS STEEL | | | | | | | | |
| THIN/ | stainless steel AISI 304 DIN 1.4301 |  | 19400 | 19401 | 19402 | 19403 | 19404 | 19405 |
| | <i>euro/pc</i> | | 290,86 | 302,81 | 318,70 | 333,33 | 350,44 | 380,96 |

CLASSIC COVER - pack 10 pcs

| ART. | finishing | | 60 cm | 70 cm | 80 cm | 90 cm | 100 cm | 120 cm |
|------------------------|---|---|-------|-------|-------|-------|--------|--------|
| STAINLESS STEEL | | | | | | | | |
| XTC/ | satin stainless steel AISI 304 DIN 1.4301 |  | 19410 | 19412 | 19414 | 19416 | 19418 | 19420 |
| | polished stainless steel AISI 304 DIN 1.4301 |  | 19411 | 19413 | 19415 | 19417 | 19419 | 19421 |
| | <i>euro/pc</i> | | 46,78 | 51,83 | 56,86 | 62,37 | 66,56 | 76,16 |

CUBE COVER - pack 10 pcs

| ART. | finishing | | 60 cm | 70 cm | 80 cm | 90 cm |
|------------------------|--|---|-------|-------|-------|-------|
| STAINLESS STEEL | | | | | | |
| XTCC/ | satin stainless steel AISI 304 DIN 1.4301 |  | 19430 | 19431 | 19432 | 19433 |
| | <i>euro/pc</i> | | 58,77 | 63,82 | 68,85 | 74,36 |

SINGLE LINE COVER - pack 10 pcs

| ART. | finishing | | 60 cm | 70 cm | 80 cm | 90 cm |
|-------------|---|---|-------|-------|-------|-------|
| XTL/ | polished stainless steel AISI 304 DIN 1.4301 |  | 19440 | 19441 | 19442 | 19443 |
| | <i>euro/pc</i> | | 58,77 | 63,82 | 68,85 | 74,36 |

TILE COVER - pack 10 pcs

| ART. | finishing | | 60 cm | 70 cm | 80 cm | 90 cm |
|-------------|--|---|-------|-------|-------|-------|
| XTT/ | stainless steel AISI 304 DIN 1.4301 |  | 19450 | 19451 | 19452 | 19453 |
| | <i>euro/pc</i> | | 58,77 | 63,82 | 68,85 | 74,36 |

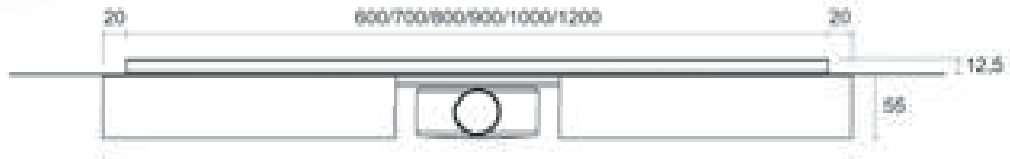
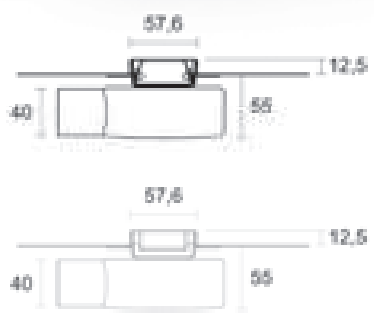
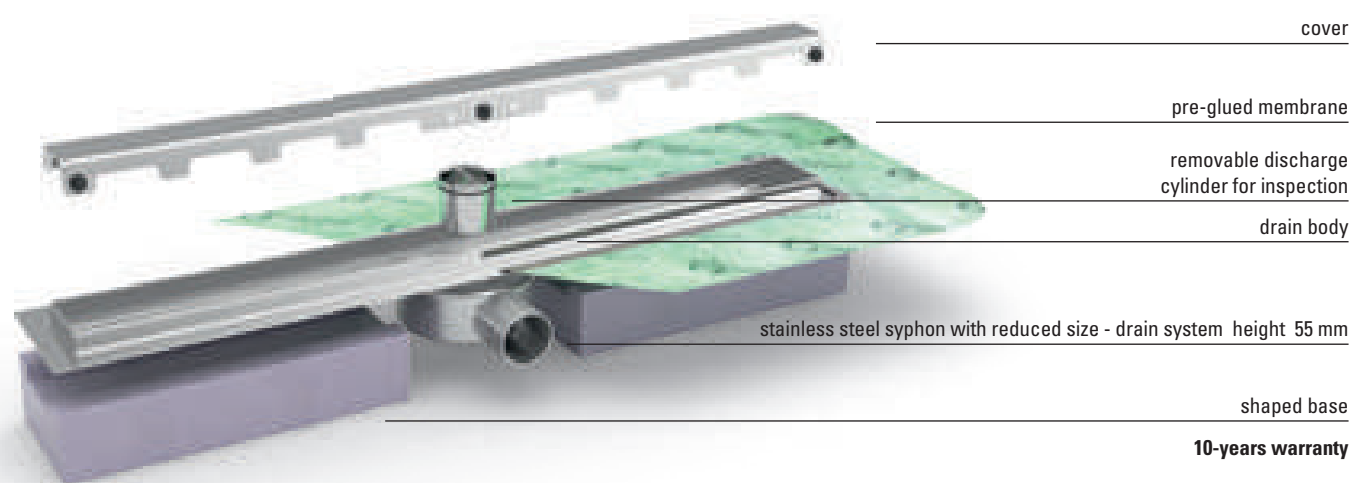

slim drain

slimdrain

Slim Drain is a line of flush with the floor shower drains for a quick and easy installation, which allows to customize the shower with any kind of covering and any tile thickness by choosing Slim Drain Invisible. Thanks to the syphon with low thickness and the height of the shower drain of just 65 mm, they are particularly suitable for refurbishments or in spaces where lightness and versatility are the main features.

ADVANTAGES

- Installation flush with the floor (it eliminates architectural barriers)
- Possibility of installation close to the wall
- Height of the shower drain of 65 mm (laying surface)
- Suitable for any tile thickness (Slim Invisible version)
- Adjustable frame (thickness 7-12,5 mm), Slim Invisible excluded.
- Shower drains with certification EN 1253-1 (minimum flow rate of 24 l/min)
- Integrated adjusting supports for an easy levelling
- Integrated waterproof membrane to reduce the risk of seepages
- Possibility of inspection of the syphon for periodic cleaning
- Filter for cleaning/hair
- Quick installation
- Drain adapter from 40 to 50 mm included



classic cover - polished stainless steel AISI 304 DIN 1.4301



classic cover - satin stainless steel AISI 304 DIN 1.4301

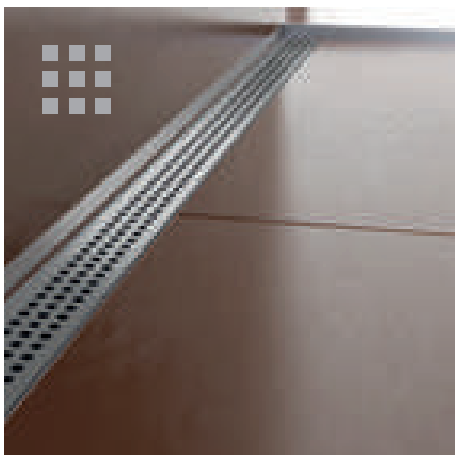

cube cover - satin stainless steel AISI 304 DIN 1.4301

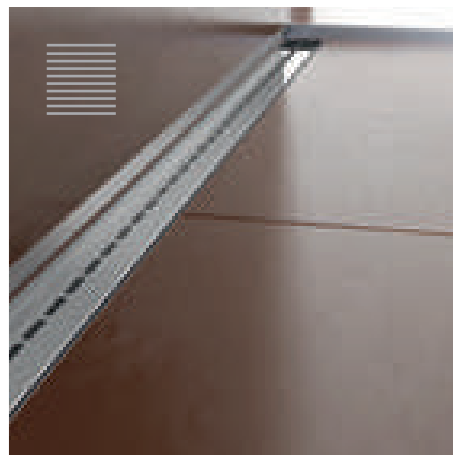

single line cover - polished stainless steel AISI 304 DIN 1.4301

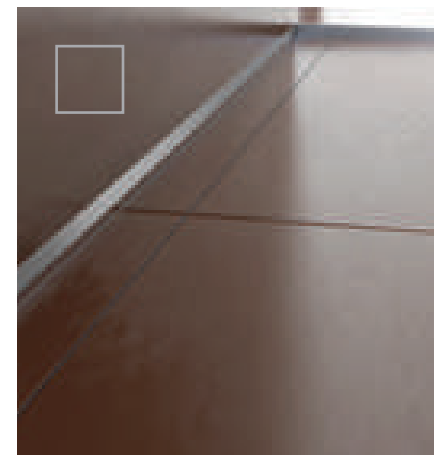



slim invisible - stainless steel AISI 304 DIN 1.4301

SLIM DRAIN - BASE - pack 10 pcs

| ART. | finishing | | 60 cm | 70 cm | 80 cm | 90 cm | 100 cm | 120 cm |
|------------------------|--|---|---------------|---------------|---------------|---------------|---------------|---------------|
| STAINLESS STEEL | | | | | | | | |
| SLIM/ | stainless steel AISI 304 DIN 1.4301 |  | 19504 | 19506 | 19508 | 19510 | 19512 | 19514 |
| | <i>euro/pc</i> | | 348,00 | 361,42 | 374,87 | 389,51 | 401,71 | 428,59 |

CLASSIC COVER - pack 10 pcs

| ART. | finishing | | 60 cm | 70 cm | 80 cm | 90 cm | 100 cm | 120 cm |
|------------------------|---|---|--------------|--------------|--------------|--------------|--------------|--------------|
| STAINLESS STEEL | | | | | | | | |
| XSC/ | satin stainless steel AISI 304 DIN 1.4301 |  | 19524 | 19526 | 19528 | 19530 | 19532 | 19534 |
| | polished stainless steel AISI 304 DIN 1.4301 |  | 19523 | 19525 | 19527 | 19529 | 19531 | 19533 |
| | <i>euro/pc</i> | | 31,75 | 34,19 | 37,86 | 40,30 | 43,97 | 50,07 |

CUBE COVER - pack 10 pcs

| ART. | finishing | | 60 cm | 70 cm | 80 cm | 90 cm |
|------------------------|--|---|--------------|--------------|--------------|--------------|
| STAINLESS STEEL | | | | | | |
| XSCC/ | satin stainless steel AISI 304 DIN 1.4301 |  | 19544 | 19546 | 19548 | 19550 |
| | <i>euro/pc</i> | | 31,75 | 34,19 | 37,86 | 40,30 |

SINGLE LINE COVER - pack 10 pcs

| ART. | finishing | | 60 cm | 70 cm | 80 cm | 90 cm |
|-------------|---|---|--------------|--------------|--------------|--------------|
| XSL/ | polished stainless steel AISI 304 DIN 1.4301 |  | 19563 | 19565 | 19567 | 19569 |
| | <i>euro/pc</i> | | 31,75 | 34,19 | 37,86 | 40,30 |

SLIM INVISIBLE - BASE + COVER - pack 10 pcs

| ART. | finishing | | 60 cm | 70 cm | 80 cm | 90 cm |
|----------------|--|---|---------------|---------------|---------------|---------------|
| SLIM-I/ | stainless steel AISI 304 DIN 1.4301 |  | 19505 | 19507 | 19509 | 19511 |
| | <i>euro/pc</i> | | 354,10 | 367,53 | 382,18 | 394,39 |

Slim Invisible does not include the adjustable frame

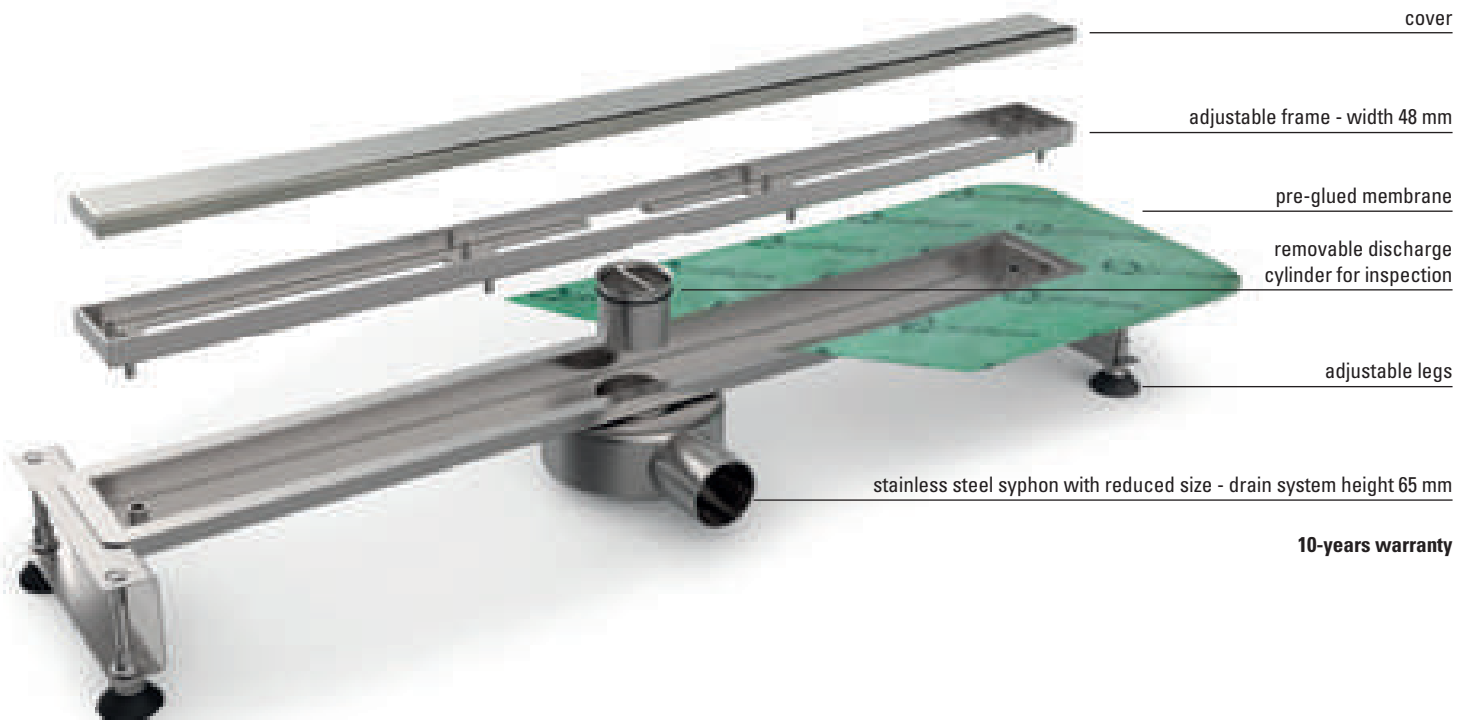
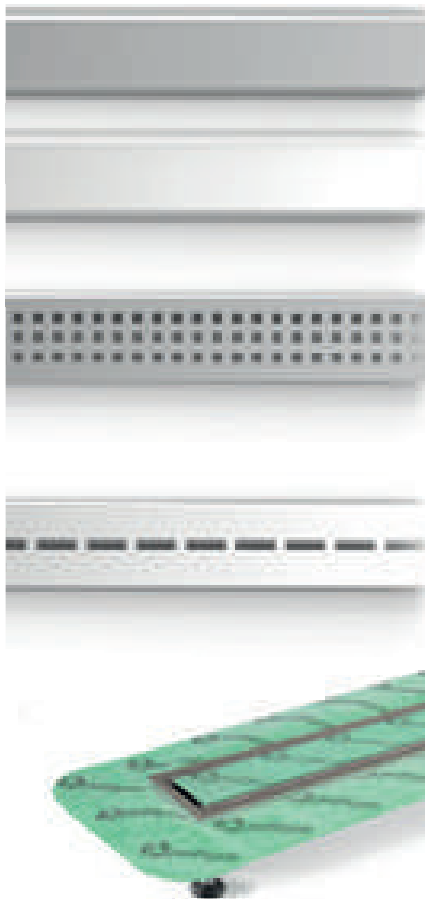

10-years warranty

smart drain

smartdrain

Smart Drain is a line of flush with the floor shower drains for a quick and easy installation, which allows to customize the shower with any kind of covering and any tile thickness by choosing Smart Drain Invisible. With high aesthetic level, varied sizes available and the height of the shower drain of 75 mm, they are particularly suitable for large size of tiles in every space.

ADVANTAGES

- Installation flush with the floor (it eliminates architectural barriers)
- Possibility of installation close to the wall
- Height of the shower drain of 75 mm (laying surface)
- Suitable for tiles with every tiles thickness (Smart Invisible version)
- Adjustable frame (thickness 7-12,5 mm), excluded Smart Invisible.
- Orientable siphoned body.
- Shower drains with certification EN 1253-1 (minimum flow rate of 24 l/min)
- Integrated regular supports for a simple set - aside at the same level.
- Integrated waterproof membrane to reduce the risk of seepages
- Suitable Inox stain steel AISI 316 - DIN 14404 version
- 180° Ruotatable classic cover for tiles (maximum thickness 10 mm)
- Possibility of inspection of the syphon for periodic cleaning
- Filter for cleaning/hair
- Quick installation



classic cover - polished stainless steel AISI 304 DIN 1.4301

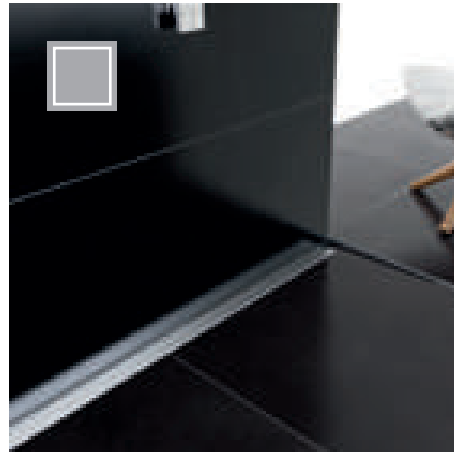

classic cover - satin stainless steel AISI 304 DIN 1.4301

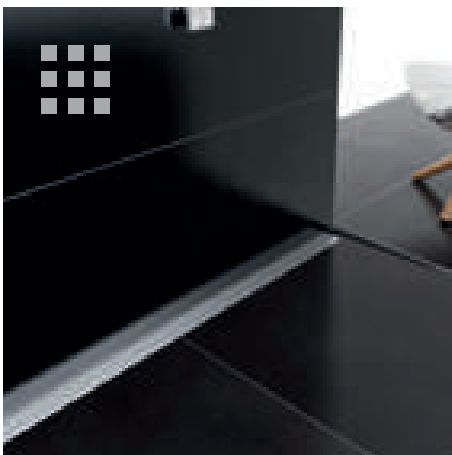

cube cover - satin stainless steel AISI 304 DIN 1.4301



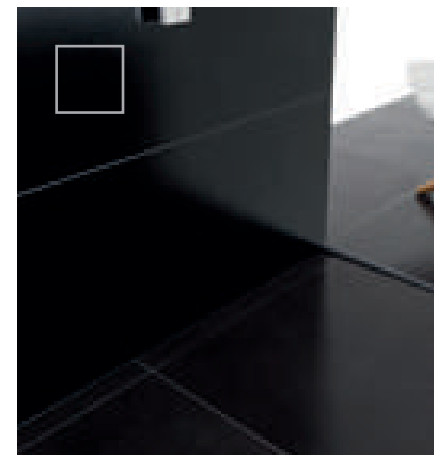

double line cover - polished stainless steel AISI 304 DIN 1.4301





smart invisible - stainless steel AISI 304 DIN 1.4301

SMART DRAIN - BASE - pack 10 pcs

| ART. | finishing | | 70 cm | 80 cm | 90 cm | 100 cm | 110 cm | 120 cm |
|------------------------|--|---|---------------|---------------|---------------|---------------|---------------|---------------|
| STAINLESS STEEL | | | | | | | | |
| SMART/ | stainless steel AISI 304 DIN 1.4301 |  | 19704 | 19706 | 19708 | 19710 | 19712 | 19714 |
| | <i>euro/pc</i> | | 302,81 | 318,70 | 333,33 | 350,44 | 365,09 | 380,96 |
| SMART3/ | stainless steel AISI 316 DIN 1.4404 |  | 19715 | 19716 | 19717 | 19718 | - | - |
| | <i>euro/pc</i> | | 332,13 | 349,23 | 367,53 | 385,85 | - | - |

CLASSIC COVER - pack 10 pcs

| ART. | finishing | | 70 cm | 80 cm | 90 cm | 100 cm | 110 cm | 120 cm |
|------------------------|---|---|--------------|--------------|--------------|--------------|--------------|--------------|
| STAINLESS STEEL | | | | | | | | |
| XLC/ | satin stainless steel AISI 304 DIN 1.4301 |  | 19724 | 19726 | 19728 | 19730 | 19732 | 19734 |
| | polished stainless steel AISI 304 DIN 1.4301 |  | 19723 | 19725 | 19727 | 19729 | 19731 | 19733 |
| | <i>euro/pc</i> | | 75,73 | 79,37 | 83,03 | 86,70 | 90,35 | 94,03 |
| XLC3/ | satin stainless steel AISI 316 DIN 1.4404 |  | 19741 | 19742 | 19743 | 19744 | - | - |
| | <i>euro/pc</i> | | 83,03 | 87,92 | 91,58 | 95,25 | - | - |

CUBE COVER - pack 10 pcs

| ART. | finishing | | 70 cm | 80 cm | 90 cm | 100 cm | 110 cm | 120 cm |
|------------------------|--|---|--------------|--------------|--------------|--------------|--------------|---------------|
| STAINLESS STEEL | | | | | | | | |
| XLCC/ | satin stainless steel AISI 304 DIN 1.4301 |  | 19764 | 19766 | 19768 | 19770 | 19772 | 19774 |
| | <i>euro/pc</i> | | 80,60 | 86,70 | 90,35 | 95,25 | 98,90 | 103,80 |

DOUBLE LINE COVER - pack 10 pcs

| ART. | finishing | | 70 cm | 80 cm | 90 cm | 100 cm | 110 cm | 120 cm |
|------------------------|---|---|--------------|--------------|--------------|--------------|--------------|---------------|
| STAINLESS STEEL | | | | | | | | |
| XLL/ | polished stainless steel AISI 304 DIN 1.4301 |  | 19783 | 19785 | 19787 | 19789 | 19791 | 19793 |
| | <i>euro/pc</i> | | 80,60 | 86,70 | 90,35 | 95,25 | 98,90 | 103,80 |

SMART INVISIBLE - BASE + COVER - pack 10 pcs

| ART. | finishing | | 70 cm | 80 cm | 90 cm | 100 cm | 110 cm | 120 cm |
|------------------------|--|---|---------------|---------------|---------------|---------------|---------------|---------------|
| STAINLESS STEEL | | | | | | | | |
| SMART-I/ | stainless steel AISI 304 DIN 1.4301 |  | 19703 | 19705 | 19707 | 19709 | 19711 | 19713 |
| | <i>euro/pc</i> | | 283,29 | 300,37 | 326,03 | 330,90 | 346,77 | 361,42 |

Smart Invisible does not include the adjustable frame

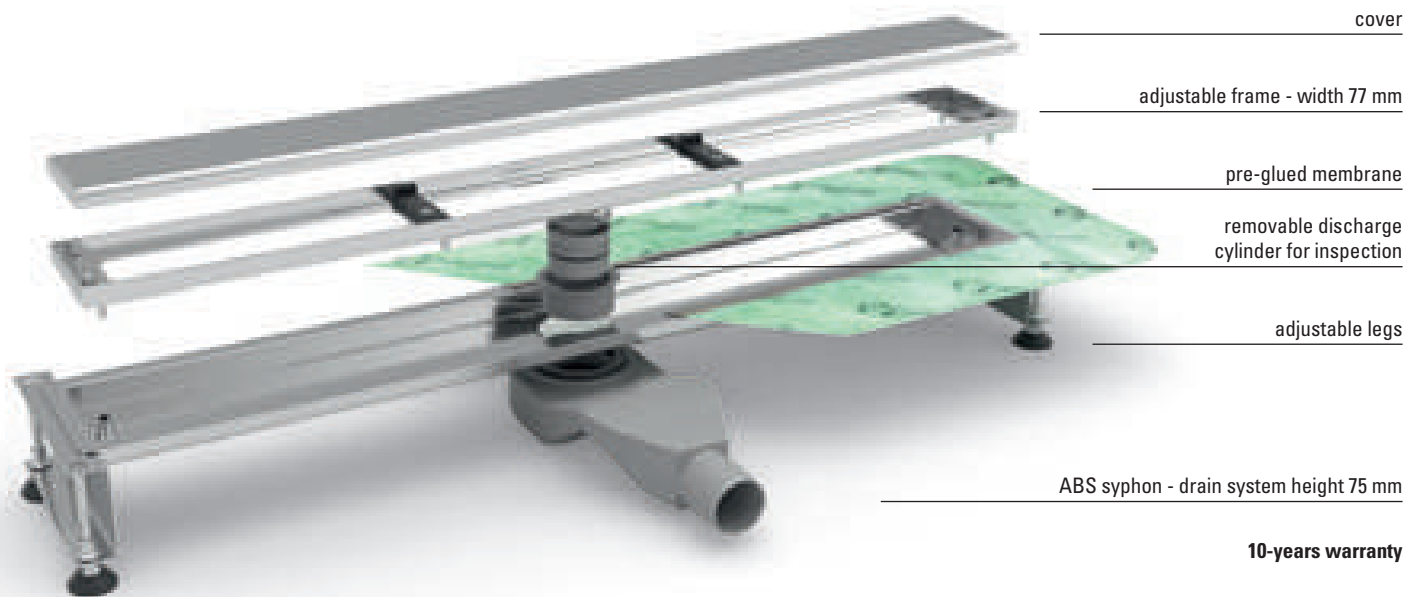
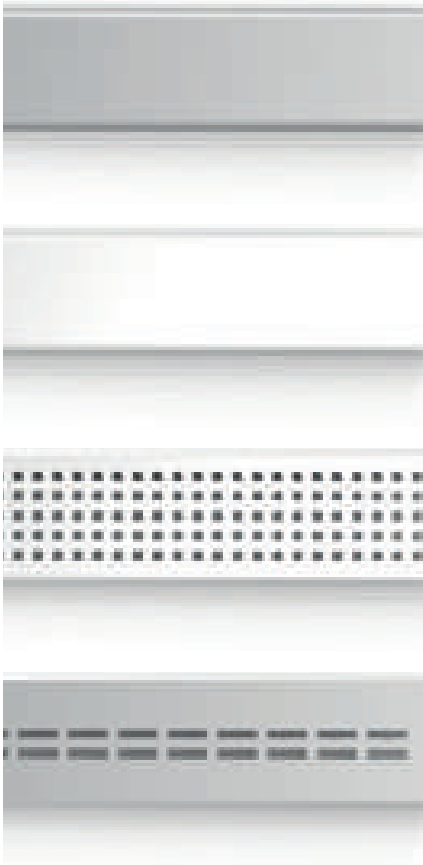

Q drain

q-drain

Q-Drain is a line of point drainages for flush with the floor showers which are quick and easy to install and allow to customize the shower with any kind of covering. Provided with insulating flange and with a height of 72/78 mm, they are the ideal solution for traditional showers flush with the floor.

ADVANTAGES

- Installation flush with the floor (it eliminates architectural barriers)
- Height of the point drainage of 72/78 mm (laying surface)
- Directable syphon
- Shower drains with certification EN 1253-1 (minimum flow rate of 24 l/ min)
- Integrated waterproof membrane to reduce the risk of seepages
- Possibility of laying tiles with thickness up to 10 mm with Q Drain Tile
- Possibility of inspection of the syphon for periodic cleaning
- Filter for cleaning/hair
- Quick installation



Q Drain Cube



Q Drain Line



Q DRAIN CLASSIC - pack 10 pcs

| ART. | finishing | | 10x10 cm |
|-----------------------------------|---|--|---------------|
| STAINLESS STEEL | | | |
| floor thickness of 12,5 mm | | | |
| QDC/1010 | satin stainless steel AISI 304 DIN 1.4301 | | 19850 |
| | polished stainless steel AISI 304 DIN 1.4301 | | 19851 |
| | | | 142,74 |
| <i>euro/pc</i> | | | |

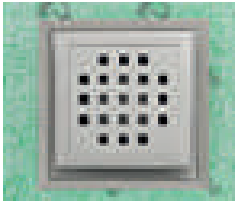

Q DRAIN CUBE - pack 10 pcs

| ART. | finishing | | 10x10 cm |
|-----------------------------------|---|--|---------------|
| STAINLESS STEEL | | | |
| floor thickness of 12,5 mm | | | |
| QDCC/1010 | satin stainless steel AISI 304 DIN 1.4301 | | 19852 |
| | polished stainless steel AISI 304 DIN 1.4301 | | 19853 |
| | | | 142,74 |
| <i>euro/pc</i> | | | |



Q DRAIN LINE - pack 10 pcs

| ART. | finishing | | 10x10 cm |
|-----------------------------------|---|--|---------------|
| STAINLESS STEEL | | | |
| floor thickness of 12,5 mm | | | |
| QDL/1010 | satin stainless steel AISI 304 DIN 1.4301 | | 19854 |
| | polished stainless steel AISI 304 DIN 1.4301 | | 19855 |
| | | | 142,74 |
| <i>euro/pc</i> | | | |

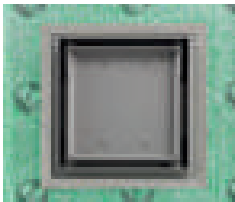

Q DRAIN TILE - pack 10 pcs

| ART. | finishing | | 10x10 cm |
|---------------------------------|--|--|---------------|
| STAINLESS STEEL | | | |
| floor thickness of 10 mm | | | |
| QDI/1010 | stainless steel AISI 304 DIN 1.4301 | | 19856 |
| | | | 142,74 |
| <i>euro/pc</i> | | | |

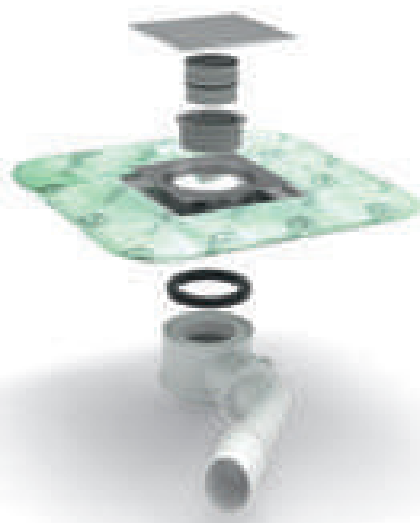

10-years warranty

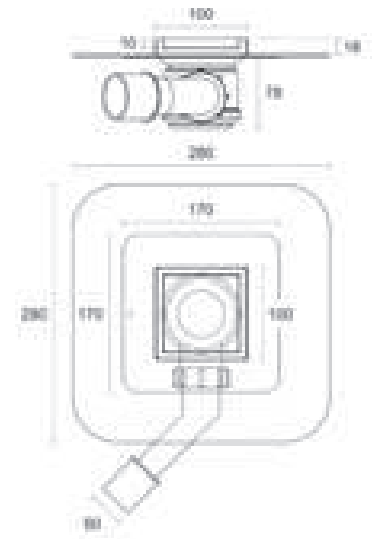
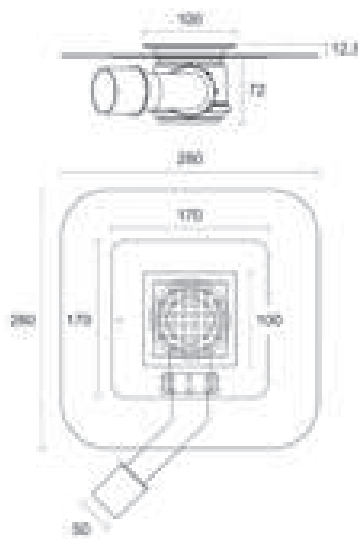

Glass Profile

The floor-level shower is a trendy and design elements that represents a real opportunity for designing bathrooms of every dimension, highlighting their practicality and beauty. Removing the traditional shower tray, the floor-level shower can be made with the same covering of the bathroom, thus creating a uniform and elegant surface. Moreover, the absence of architectural barriers makes the access easier for children, elderly people or disabled.

Profilpas offers a series of integrated solutions for floor-level showers: a system of linear floor-level drains in stainless steel, with the possibility of also opting for the invisible version, thus creating a whole with the shower ceramic covering, which is completed by a wide range of stainless steel profiles for the insertion of glass walls and for finishing the sloping surface.



Glass Profile is a line of stainless steel profiles designed to cover the difference in height of the surface with 2% slope and create a coplanar surface with a modern and linear design. The range includes two finishes: satin stainless steel and matt black colour coated stainless steel. The versatility of these two colours become guarantee of elegance, assuring a minimalist and trendy effect.

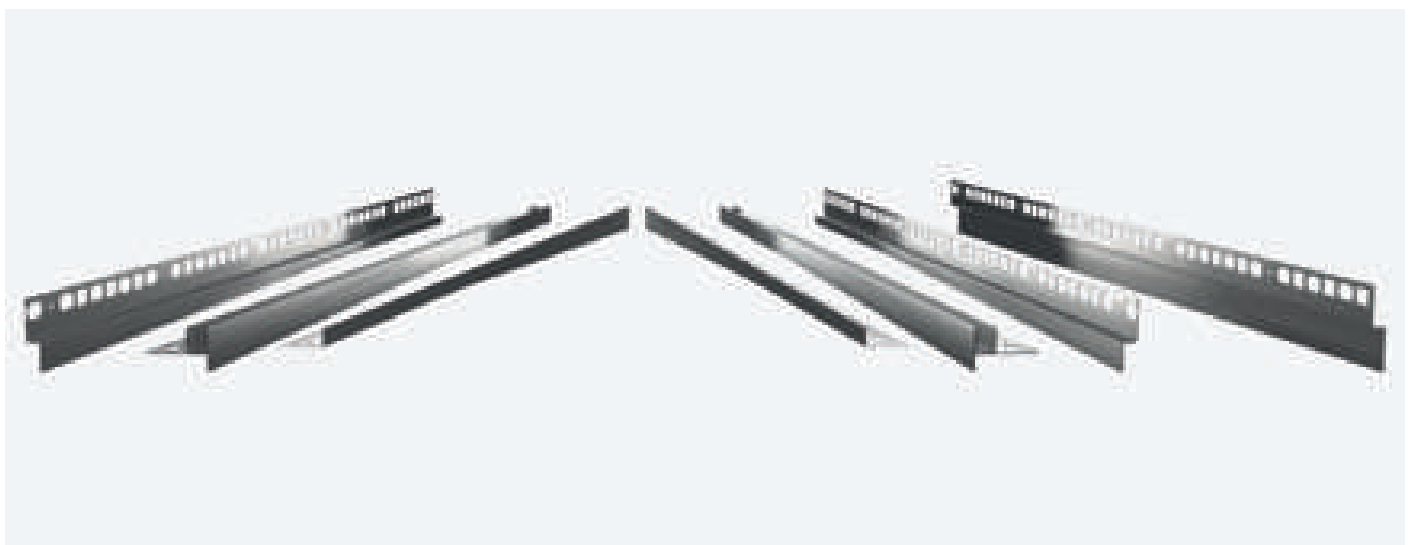
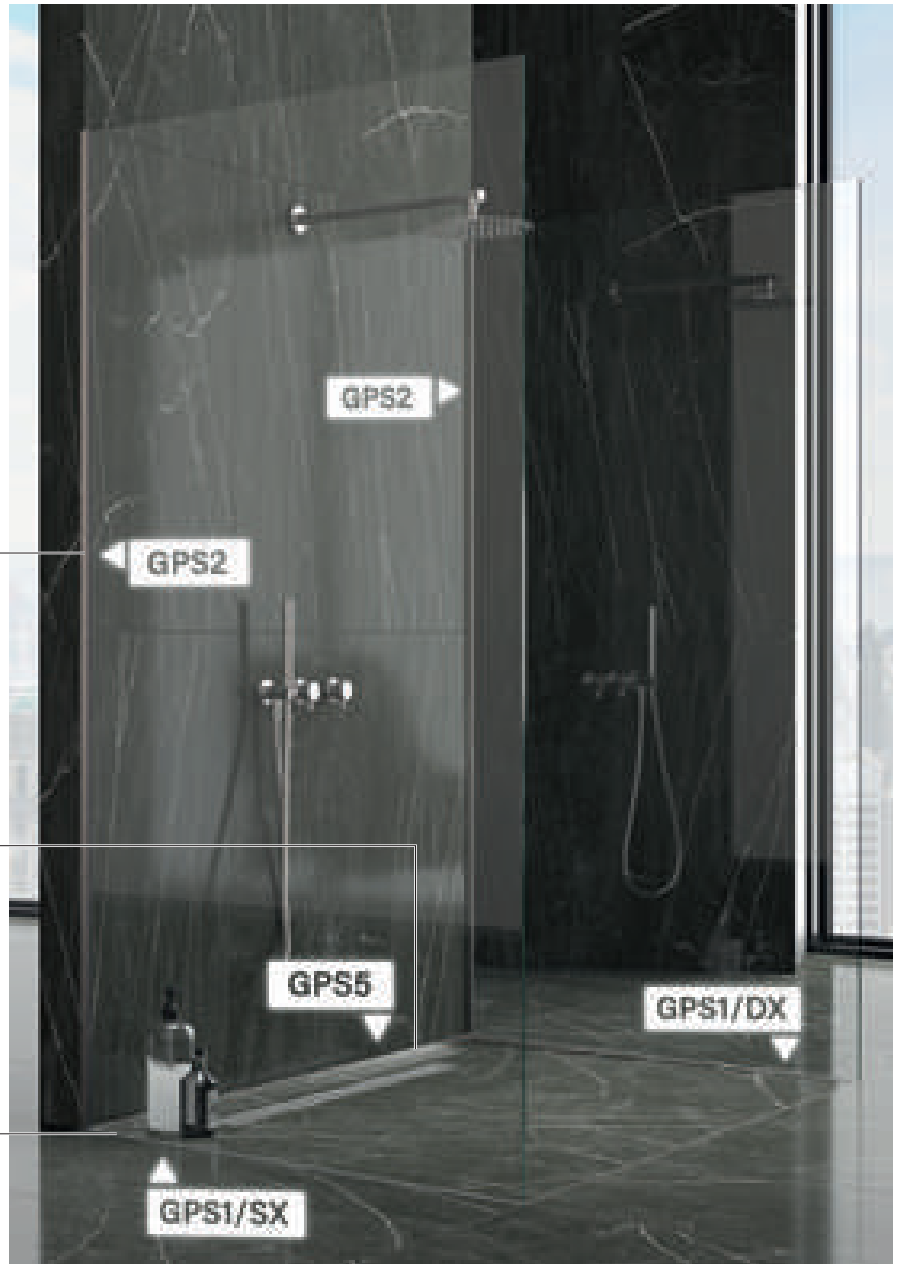

glass profile

Glass Profile GPS1/ is a stainless steel profile for the insertion of glass walls of floor-level showers. GPS1/ is provided with a 2% slope on the shower inner side for a perfect aesthetic solution of the sloped surface. On completion of the profile, there is GPS/6, the end cap for hiding the section of the glass wall.

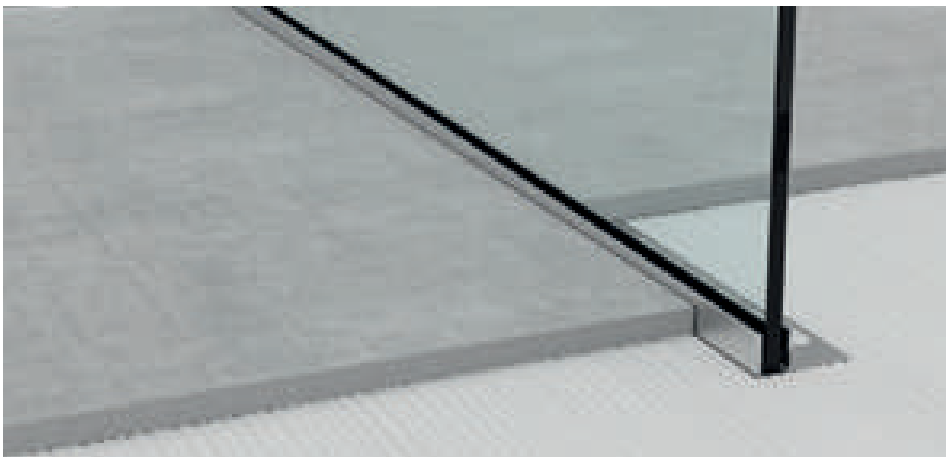

GPS1/DX/19 satin stainless steel AISI 304 DIN 1.4301

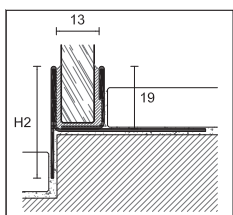

GPS1/DX/19

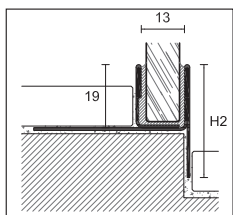

GPS1/SX/19

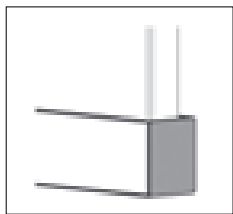

GPS/6



silicone glazing beads

GLASS PROFILE

pack 5 pcs

| ART. | GPS1/ /19 | | | | | | | |
|-----------|-----------|--|-----|--|-----|--|-----|--|
| | DX | | SX | | DX | | SX | |
| length cm | 98 | | 120 | | 148 | | 200 | |
| H2 mm | 34 | | 37 | | 42 | | 60 | |

STAINLESS STEEL

| | | | | | | | | | |
|---|---|--------------|--------------|--------------|--------------|--------------|--------------|---------------|---------------|
| satin stainless steel AISI 304 DIN 1.4301 |  | 31505 | 31507 | 31515 | 31517 | 31525 | 31527 | 31535 | 31537 |
| euro/pc | | 74,00 | 74,00 | 78,96 | 78,96 | 88,83 | 88,83 | 146,80 | 146,80 |

NEW

MATT BLACK COLOUR-COATED STAINLESS STEEL

| | | | | | | | | | |
|---|---|--------------|--------------|--------------|--------------|---------------|---------------|---|---|
| matt black RAL 9005 colour-coated stainless steel AISI 304 DIN 1.4301 |  | 31506 | 31508 | 31516 | 31518 | 31526 | 31528 | - | - |
| euro/pc | | 82,31 | 82,31 | 89,15 | 89,15 | 101,39 | 101,39 | - | - |

individually packed

GLASS PROFILE - END CAP FOR GPS1//19

pack 5 pcs

| ART. | GPS/6 | | | | | | | | |
|---|---|--|--|--|--|--|--|-------------|--|
| satin stainless steel AISI 304 DIN 1.4301 |  | | | | | | | 31564 | |
| euro/pc | | | | | | | | 6,93 | |

NEW

MATT BLACK COLOUR-COATED STAINLESS STEEL

| | | | | | | | | | |
|---|---|--|--|--|--|--|--|-------------|--|
| matt black RAL 9005 colour-coated stainless steel AISI 304 DIN 1.4301 |  | | | | | | | 31566 | |
| euro/pc | | | | | | | | 8,69 | |

no partial packaging

TRANSPARENT SILICONE GLAZING BEADS

pack 5 mt

| ART. | measures | | |
|-------------|------------------|------|--------------|
| GG/2 | thickness | 2 mm | 31590 |
| | euro/pack | | 19,39 |
| GG/3 | thickness | 3 mm | 31592 |
| | euro/pack | | 20,54 |
| GG/4 | thickness | 4 mm | 31594 |
| | euro/pack | | 22,45 |

no partial packaging

Complete the article code with DX and SX (DX = RH and SX = LH) - for example GPS1//19 RH becomes GPS1/DX/19. For a single piece, see sales conditions on page 288

Glass Profile GPS2/ and GPS14/12 are two stainless steel profiles for inserting glass walls on the wall covering. GPS2/ is simple to install, is suitable for tiles of any thickness and does not require drilling. GPS/6 is the end cap to complete the profile, to hide the visible section of the glass wall. GPS14/12 can be fixed directly onto the already-laid wall covering.

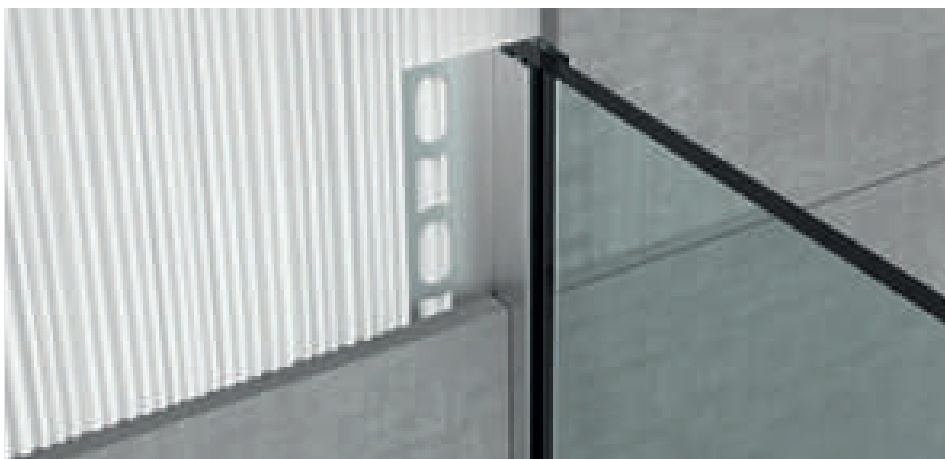

GPS2/19 satin stainless steel AISI 304 DIN 1.4301

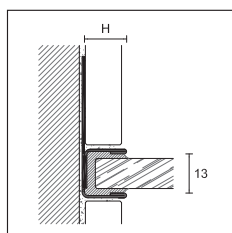

GPS2/

GLASS PROFILE

length = 210 cm - pack 5 pcs

| ART. | finishing | NEW 10 | NEW 12,5 | 19 |
|------|-----------|--------|----------|----|
|------|-----------|--------|----------|----|

STAINLESS STEEL

| | | | | | |
|-------|---|--|-------|-------|-------|
| GPS2/ | satin stainless steel AISI 304 DIN 1.4301 | | 31541 | 31542 | 31543 |
| | euro/pc | | 70,18 | 71,68 | 76,18 |

NEW MATT BLACK COLOUR-COATED STAINLESS STEEL

| | | | | | |
|-------|---|--|-------|-------|-------|
| GPS2/ | matt black RAL 9005 colour-coated stainless steel AISI 304 DIN 1.4301 | | 31546 | 31547 | 31545 |
| | euro/pc | | 88,02 | 89,52 | 94,02 |

individually packed

GLASS PROFILE

length = 250 cm - pack 5 pcs

| ART. | finishing | NEW 10 | NEW 12,5 | 19 |
|------|-----------|--------|----------|----|
|------|-----------|--------|----------|----|

STAINLESS STEEL

| | | | | | |
|-------|---|--|-------|-------|-------|
| GPS2/ | satin stainless steel AISI 304 DIN 1.4301 | | 31548 | 31549 | 31544 |
| | euro/pc | | 87,70 | 89,62 | 95,22 |

individually packed

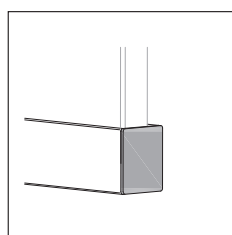

GPS/6

GLASS PROFILE - END CAP FOR GPS2/19

pack 5 pcs

| ART. | GPS/6 |
|------|-------|
|------|-------|

STAINLESS STEEL

| | | |
|---|---------|-------|
| satin stainless steel AISI 304 DIN 1.4301 | | 31564 |
| | euro/pc | 6,93 |

NEW MATT BLACK COLOUR-COATED STAINLESS STEEL

| | | |
|---|---------|-------|
| matt black RAL 9005 colour-coated stainless steel AISI 304 DIN 1.4301 | | 31566 |
| | euro/pc | 8,69 |

no partial packaging

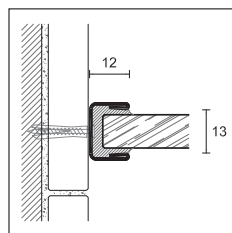

GPS14/12

GLASS PROFILE

pack 5 pcs

| ART. | GPS14/12 |
|------|----------|
|------|----------|

STAINLESS STEEL

| length cm | 210 | 250 | |
|---|-------|-------|-------|
| satin stainless steel AISI 304 DIN 1.4301 | | 32000 | 32001 |
| euro/pc | 20,90 | 24,89 | |

individually packed

Complete the article code with H measure (for example GPS2/ for H=10 becomes GPS2/10).

For a single piece, see sales conditions on page 288

glass profile

Glass Profile GPS3/ is a stainless steel profile provided with a 2% slope on the shower inner side for a perfect aesthetic solution of the sides of the sloped surface.

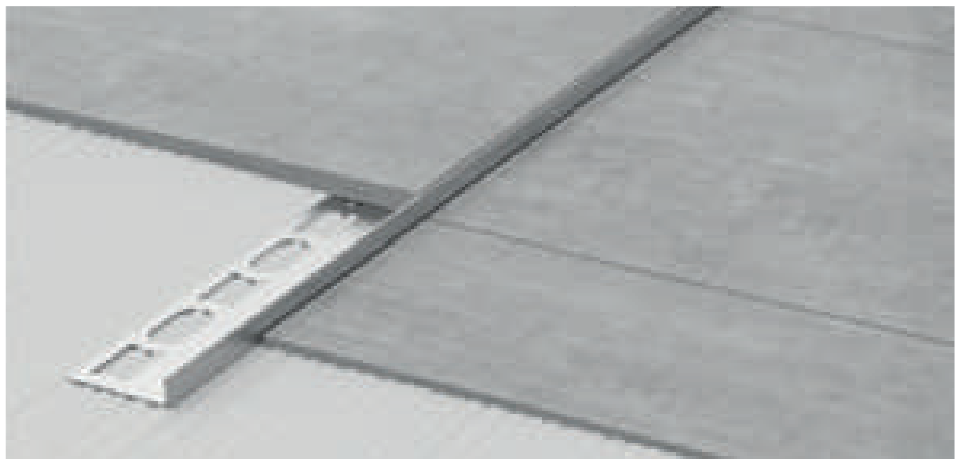

GPS3/SX/10 satin stainless steel AISI 304 DIN 1.4301

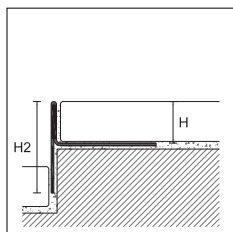

GPS3/DX/

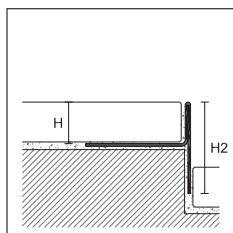

GPS3/SX/

GLASS PROFILE

length = 98 cm - pack 5 pcs

| ART. | finishing | H | H2 | DX | SX |
|---|---|------|------|--------------|--------------|
| STAINLESS STEEL | | | | | |
| GPS3/ /10 | satin stainless steel AISI 304 DIN 1.4301 <i>euro/pc</i> | 10 | 25 | 31615 | 31617 |
| | | | | 38,79 | 38,79 |
| NEW GPS3/ /11 | satin stainless steel AISI 304 DIN 1.4301 <i>euro/pc</i> | 11 | 26 | 31619 | 31620 |
| | | | | 39,11 | 39,11 |
| GPS3/ /12 | satin stainless steel AISI 304 DIN 1.4301 <i>euro/pc</i> | 12,5 | 27,5 | 31625 | 31627 |
| | | | | 39,47 | 39,47 |
| NEW MATT BLACK COLOUR-COATED STAINLESS STEEL | | | | | |
| GPS3/ /10 | matt black RAL 9005 colour-coated stainless steel AISI 304 DIN 1.4301 <i>euro/pc</i> | 10 | 25 | 31616 | 31618 |
| | | | | 47,12 | 47,12 |
| GPS3/ /11 | matt black RAL 9005 colour-coated stainless steel AISI 304 DIN 1.4301 <i>euro/pc</i> | 11 | 26 | 31629 | 31630 |
| | | | | 47,44 | 47,44 |
| GPS3/ /12 | matt black RAL 9005 colour-coated stainless steel AISI 304 DIN 1.4301 <i>euro/pc</i> | 12,5 | 27,5 | 31626 | 31628 |
| | | | | 47,81 | 47,8 |

individually packed

GLASS PROFILE

length = 120 cm - pack 5 pcs

| ART. | finishing | H | H2 | DX | SX |
|---|---|------|------|--------------|--------------|
| STAINLESS STEEL | | | | | |
| GPS3/ /10 | satin stainless steel AISI 304 DIN 1.4301 <i>euro/pc</i> | 10 | 28 | 31645 | 31647 |
| | | | | 41,33 | 41,33 |
| NEW GPS3/ /11 | satin stainless steel AISI 304 DIN 1.4301 <i>euro/pc</i> | 11 | 29 | 31649 | 31650 |
| | | | | 41,87 | 41,87 |
| GPS3/ /12 | satin stainless steel AISI 304 DIN 1.4301 <i>euro/pc</i> | 12,5 | 30,5 | 31655 | 31657 |
| | | | | 42,48 | 42,48 |
| NEW MATT BLACK COLOUR-COATED STAINLESS STEEL | | | | | |
| GPS3/ /10 | matt black RAL 9005 colour-coated stainless steel AISI 304 DIN 1.4301 <i>euro/pc</i> | 10 | 28 | 31646 | 31648 |
| | | | | 51,52 | 51,52 |
| GPS3/ /11 | matt black RAL 9005 colour-coated stainless steel AISI 304 DIN 1.4301 <i>euro/pc</i> | 11 | 29 | 31652 | 31654 |
| | | | | 52,15 | 52,15 |
| GPS3/ /12 | matt black RAL 9005 colour-coated stainless steel AISI 304 DIN 1.4301 <i>euro/pc</i> | 12,5 | 30,5 | 31656 | 31658 |
| | | | | 52,68 | 52,68 |

individually packed







GPS3/ is also available in 8 mm height on request, with a minimum order of 30 pcs.

Complete the article code with DX and SX (DX = RH and SX = LH) - for example GPS3/ /10 RH becomes GPS3/DX/10)

For a single piece, see sales conditions on page 288

GLASS PROFILE



length = 148 cm - pack 5 pcs

| ART. | finishing | | H | H2 | DX | SX |
|---|---|--|------|------|-----------------------|-----------------------|
| STAINLESS STEEL | | | | | | |
| GPS3/ /10 | satin stainless steel AISI 304 DIN 1.4301 <i>euro/pc</i> |  | 10 | 33 | 31675 45,72 | 31677 45,72 |
| NEW GPS3/ /11 | satin stainless steel AISI 304 DIN 1.4301 <i>euro/pc</i> |  | 11 | 34 | 31679 46,32 | 31680 46,32 |
| GPS3/ /12 | satin stainless steel AISI 304 DIN 1.4301 <i>euro/pc</i> |  | 12,5 | 35,5 | 31685 46,87 | 31687 46,87 |
| NEW MATT BLACK COLOUR-COATED STAINLESS STEEL | | | | | | |
| GPS3/ /10 | matt black RAL 9005 colour-coated stainless steel AISI 304 DIN 1.4301 <i>euro/pc</i> |  | 10 | 33 | 31676 58,19 | 31678 58,19 |
| GPS3/ /11 | matt black RAL 9005 colour-coated stainless steel AISI 304 DIN 1.4301 <i>euro/pc</i> |  | 11 | 34 | 31682 58,83 | 31684 58,83 |
| GPS3/ /12 | matt black RAL 9005 colour-coated stainless steel AISI 304 DIN 1.4301 <i>euro/pc</i> |  | 12,5 | 35,5 | 31686 59,47 | 31688 59,47 |

individually packed

GLASS PROFILE

length = 200 cm - pack 5 pcs

| ART. | finishing | | H | H2 | DX | SX |
|------------------------|--|--|------|------|-----------------------|-----------------------|
| STAINLESS STEEL | | | | | | |
| GPS3/ /10 | satin stainless steel AISI 304 DIN 1.4301 <i>euro/pc</i> |  | 10 | 51 | 31694 68,92 | 31695 68,92 |
| GPS3/ /12 | satin stainless steel AISI 304 DIN 1.4301 <i>euro/pc</i> |  | 12,5 | 53,5 | 31698 70,89 | 31699 70,89 |

individually packed



glass profile

Glass Profile GPS4/ is a stainless steel profile provided with a 2% slope on the shower inner side. It connects the sloped floor and the covering perfectly, thus avoiding the oblique cut of the tiles.

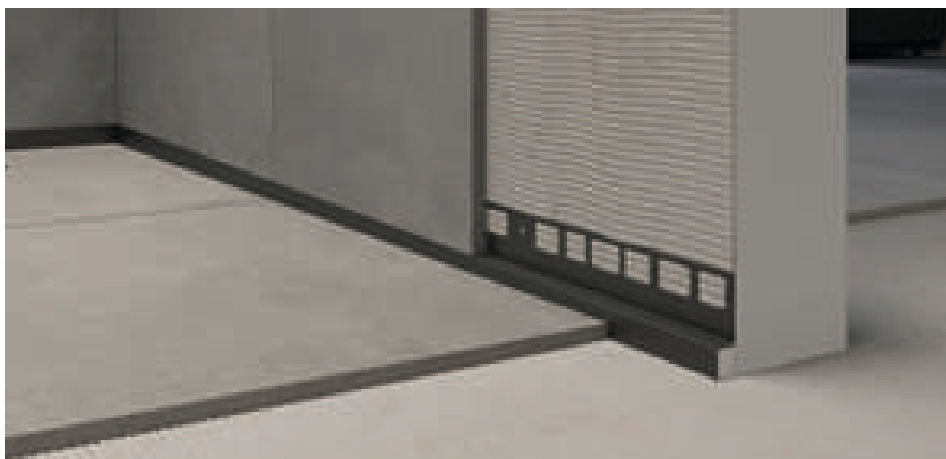

GPS4/DX/10 matt black RAL 9005 colour-coated stainless steel AISI 304 DIN 1.4301

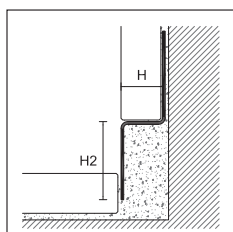

GPS4/DX/

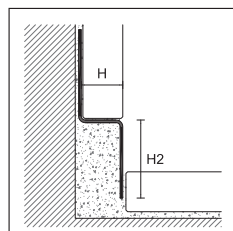

GPS4/SX/

GLASS PROFILE

length = 98 cm - pack 5 pcs

| ART. | finishing | H | H2 | DX | SX |
|------------------------|--|------|----|--------------|--------------|
| STAINLESS STEEL | | | | | |
| GPS4/ /10 | satin stainless steel AISI 304 DIN 1.4301 | 10 | 23 | 31715 | 31717 |
| | <i>euro/pc</i> | | | 38,21 | 38,21 |
| NEW GPS4/ /11 | satin stainless steel AISI 304 DIN 1.4301 | 11 | 23 | 31716 | 31718 |
| | <i>euro/pc</i> | | | 38,48 | 38,48 |
| GPS4/ /12 | satin stainless steel AISI 304 DIN 1.4301 | 12,5 | 23 | 31725 | 31727 |
| | <i>euro/pc</i> | | | 38,63 | 38,63 |

NEW MATT BLACK COLOUR-COATED STAINLESS STEEL

| | | | | | |
|------------------|---|------|----|--------------|--------------|
| GPS4/ /10 | matt black RAL 9005 colour-coated stainless steel AISI 304 DIN 1.4301 | 10 | 23 | 31719 | 31720 |
| | <i>euro/pc</i> | | | 46,53 | 46,53 |
| GPS4/ /11 | matt black RAL 9005 colour-coated stainless steel AISI 304 DIN 1.4301 | 11 | 23 | 31722 | 31724 |
| | <i>euro/pc</i> | | | 46,80 | 46,80 |
| GPS4/ /12 | matt black RAL 9005 colour-coated stainless steel AISI 304 DIN 1.4301 | 12,5 | 23 | 31726 | 31728 |
| | <i>euro/pc</i> | | | 46,95 | 46,95 |

individually packed

GLASS PROFILE

length = 120 cm - pack 5 pcs

| ART. | finishing | H | H2 | DX | SX |
|------------------------|--|------|----|--------------|--------------|
| STAINLESS STEEL | | | | | |
| GPS4/ /10 | satin stainless steel AISI 304 DIN 1.4301 | 10 | 26 | 31745 | 31747 |
| | <i>euro/pc</i> | | | 40,77 | 40,77 |
| NEW GPS4/ /11 | satin stainless steel AISI 304 DIN 1.4301 | 11 | 26 | 31746 | 31748 |
| | <i>euro/pc</i> | | | 41,02 | 41,02 |
| GPS4/ /12 | satin stainless steel AISI 304 DIN 1.4301 | 12,5 | 26 | 31755 | 31757 |
| | <i>euro/pc</i> | | | 41,19 | 41,19 |

GPS4/ is also available in 8 mm height on request, with a minimum order of 30 pcs.

Completare codice articolo con DX e SX (for example GPS4/ /8 DX becomes GPS4/DX/8)

For a single piece, see sales conditions on page 288

NEW MATT BLACK COLOUR-COATED STAINLESS STEEL

| | | | | | | |
|------------------|---|---|------|----|--------------|--------------|
| GPS4/ /10 | matt black RAL 9005 colour-coated stainless steel AISI 304 DIN 1.4301 | ■ | 10 | 26 | 31749 | 31750 |
| | <i>euro/pc</i> | | | | 50,94 | 50,94 |
| GPS4/ /11 | matt black RAL 9005 colour-coated stainless steel AISI 304 DIN 1.4301 | ■ | 11 | 26 | 31752 | 31754 |
| | <i>euro/pc</i> | | | | 51,20 | 51,20 |
| GPS4/ /12 | matt black RAL 9005 colour-coated stainless steel AISI 304 DIN 1.4301 | ■ | 12,5 | 26 | 31756 | 31758 |
| | <i>euro/pc</i> | | | | 51,37 | 51,37 |

individually packed

GLASS PROFILE

length = 148 cm - pack 5 pcs

| ART. | finishing | | H | H2 | DX | SX |
|------------------------|--|---|------|----|--------------|--------------|
| STAINLESS STEEL | | | | | | |
| GPS4/ /10 | satin stainless steel AISI 304 DIN 1.4301 | ▨ | 10 | 31 | 31775 | 31777 |
| | <i>euro/pc</i> | | | | 44,90 | 44,90 |
| NEW GPS4/ /11 | satin stainless steel AISI 304 DIN 1.4301 | ▨ | 11 | 31 | 31776 | 31778 |
| | <i>euro/pc</i> | | | | 45,16 | 45,16 |
| GPS4/ /12 | satin stainless steel AISI 304 DIN 1.4301 | ▨ | 12,5 | 31 | 31785 | 31787 |
| | <i>euro/pc</i> | | | | 45,48 | 45,48 |

NEW MATT BLACK COLOUR-COATED STAINLESS STEEL

| | | | | | | |
|------------------|---|---|------|----|--------------|--------------|
| GPS4/ /10 | matt black RAL 9005 colour-coated stainless steel AISI 304 DIN 1.4301 | ■ | 10 | 31 | 31779 | 31780 |
| | <i>euro/pc</i> | | | | 57,46 | 57,46 |
| GPS4/ /11 | matt black RAL 9005 colour-coated stainless steel AISI 304 DIN 1.4301 | ■ | 11 | 31 | 31782 | 31784 |
| | <i>euro/pc</i> | | | | 57,72 | 57,72 |
| GPS4/ /12 | matt black RAL 9005 colour-coated stainless steel AISI 304 DIN 1.4301 | ■ | 12,5 | 31 | 31786 | 31800 |
| | <i>euro/pc</i> | | | | 58,05 | 58,05 |

individually packed

GLASS PROFILE

length = 200 cm - pack 5 pcs

| ART. | finishing | | H | H2 | DX | SX |
|------------------------|--|---|------|----|--------------|--------------|
| STAINLESS STEEL | | | | | | |
| GPS4/ /10 | satin stainless steel AISI 304 DIN 1.4301 | ▨ | 10 | 49 | 31794 | 31795 |
| | <i>euro/pc</i> | | | | 75,30 | 75,30 |
| GPS4/ /12 | satin stainless steel AISI 304 DIN 1.4301 | ▨ | 12,5 | 49 | 31798 | 31799 |
| | <i>euro/pc</i> | | | | 76,12 | 76,12 |

individually packed



GPS4/SX/10 satin stainless steel AISI 304 DIN 1.4301

glass profile

Glass Profile GPS5/ is a stainless steel profile to be positioned on the wall covering, above the shower drain with sloped surface, in order to avoid the cut of the tiles.

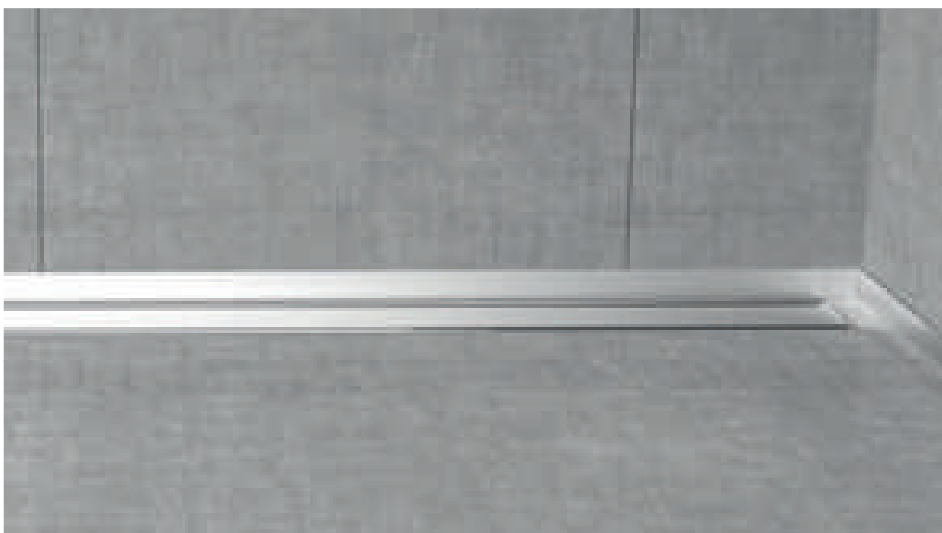



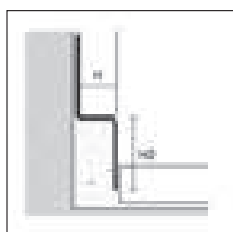



GPS5/ satin stainless steel AISI 304 DIN 1.4301



GPS5/

GLASS PROFILE

length = 125 cm - pack 5 pcs

| ART. | finishing | | H | | H2 | |
|---|---|---|------|--------------|--------------|--------------|
| STAINLESS STEEL | | | | | | |
| | | | | 23 | 33 | 45 |
| GPS5/10/ | satin stainless steel AISI 304 DIN 1.4301 |  | 10 | 31551 | 31553 | 31559 |
| | <i>euro/pc</i> | | | 30,82 | 31,38 | 32,81 |
| NEW GPS5/11/ | satin stainless steel AISI 304 DIN 1.4301 |  | 11 | 31563 | 31572 | - |
| | <i>euro/pc</i> | | | 30,95 | 31,54 | - |
| GPS5/12/ | satin stainless steel AISI 304 DIN 1.4301 |  | 12,5 | 31555 | 31557 | 31561 |
| | <i>euro/pc</i> | | | 31,10 | 31,65 | 33,08 |
| NEW MATT BLACK COLOUR-COATED STAINLESS STEEL | | | | | | |
| GPS5/10/ | matt black RAL 9005 colour-coated stainless steel AISI 304 DIN 1.4301 |  | 10 | 31567 | 31568 | - |
| | <i>euro/pc</i> | | | 41,42 | 41,98 | - |
| GPS5/11/ | matt black RAL 9005 colour-coated stainless steel AISI 304 DIN 1.4301 |  | 11 | 31570 | 31571 | - |
| | <i>euro/pc</i> | | | 41,55 | 42,14 | - |
| GPS5/12/ | matt black RAL 9005 colour-coated stainless steel AISI 304 DIN 1.4301 |  | 12,5 | 31573 | 31574 | - |
| | <i>euro/pc</i> | | | 41,70 | 42,25 | - |

individually packed

GPS5/ is also available in 8 mm height on request, with a minimum order of 30 pcs.

Complete the article code with H2 measure (for example GPS5/10/ for H2 = 23 becomes GPS5/10/23).

For a single piece, see sales conditions on page 288

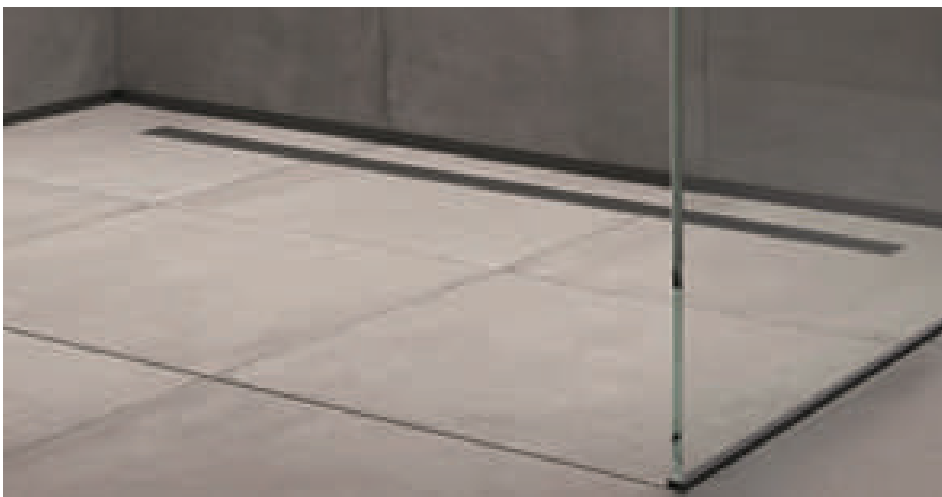

GPS5/ matt black RAL 9005 colour-coated stainless steel AISI 304 DIN 1.4301

GU/ and TGU/ are anodised aluminium profiles suitable for the insertion of glass walls on the floor and on the wall of floor-level showers.



GU/40/12 + TGU/12 silver anodised aluminium

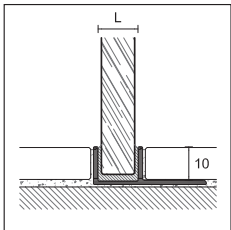

TGU/

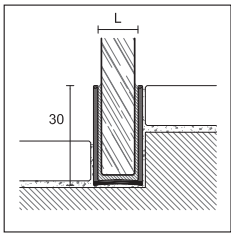

GU/30/

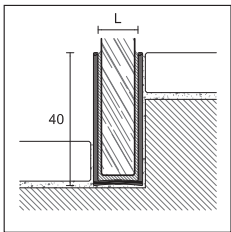

GU/40/

GLASS PROFILE

length = 270 cm - pack 10 pcs

| | | L | |
|------------------|-----------------|-------|-------|
| ART. | finishing | 12 | 14 |
| ALUMINIUM | | | |
| TGU/ | silver anodised | 67760 | 67762 |
| | euro/m | 6,48 | 6,48 |

individually packed

GLASS PROFILE

length = 270 cm - pack 10 pcs

| | | L | |
|------------------|-----------------|-------|-------|
| ART. | finishing | 12 | 14 |
| ALUMINIUM | | | |
| GU/30/ | silver anodised | 67770 | 67772 |
| | euro/m | 7,00 | 7,00 |
| GU/40/ | silver anodised | 67780 | 67782 |
| | euro/m | 8,27 | 8,27 |

individually packed

Complete the article code with L measure
(for example GU/30/ per L = 12 becomes
GU/30/12)

For a single piece, see sales conditions on page 288

wpstop

WPstop is a waterproof membrane in polyethylene with a textile in polypropylene in both sides in order to facilitate the grip of the adhesive, thus ensuring a high adhesion to the support. It is particularly suitable for the waterproofing of floors and tiled walls of bathrooms.

PAIG/ are special pre-formed pieces for waterproofing the internal corners of floor-level showers using Glass Profile GPS1 and GPS3.



sistema Wpstop



rolls



stripes

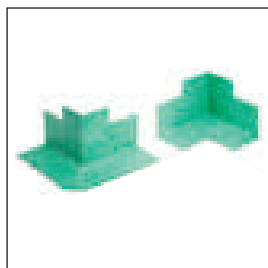

corners

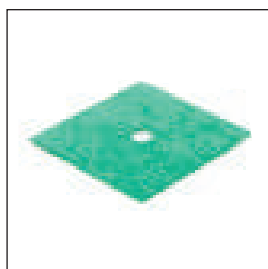

colar

WPSTOP

ART. measures

| | | |
|-------------|--|--------------|
| PR30 | roll 1 m height 30 mt length - pack 1 roll | 19900 |
| | <i>euro/m</i> | 10,37 |
| PR5 | roll 1 m height 5 mt length - pack 6 rolls | 19902 |
| | <i>euro/m</i> | 12,16 |
| PB30 | stripe 14 cm height 30 mt length - pack 1 roll | 19910 |
| | <i>euro/m</i> | 3,18 |
| PB5 | stripe 14 cm height 5 mt length - pack 6 rolls | 19912 |
| | <i>euro/m</i> | 4,12 |
| PAE | outside corner - pack 10 pcs | 19920 |
| | <i>euro/pc</i> | 7,65 |
| PAI | inside corner - pack 10 pcs | 19922 |
| | <i>euro/pc</i> | 7,65 |
| PF12 | colar cm 12x12 - pack 10 pcs | 19930 |
| | <i>euro/pc</i> | 5,95 |

no partial packaging

INSTRUCTIONS

Store in a cool and dry place, avoiding direct exposure to sunlight and heat sources.

Please refer to the technical data sheet before the installation. For special installations, please contact our technical department.

NEW WPSTOP - CORNERS FOR GLASS PROFILE GPS1 AND GPS3

| ART. | measures | RX | LH |
|-----------------|-----------------------------|-----------------------|-----------------------|
| PAIG//15 | inside corner - pack 10 pcs | 19931 | 19932 |
| | <i>euro/pc (euro/pack.)</i> | 14,31 (143,10) | 14,31 (143,10) |
| PAIG//20 | inside corner - pack 10 pcs | 19933 | 19934 |
| | <i>euro/pc (euro/pack.)</i> | 14,31 (143,10) | 14,31 (143,10) |
| PAIG//28 | inside corner - pack 10 pcs | 19935 | 19936 |
| | <i>euro/pc (euro/pack.)</i> | 14,31 (143,10) | 14,31 (143,10) |
| PAIG//38 | inside corner - pack 10 pcs | 19937 | 19938 |
| | <i>euro/pc (euro/pack.)</i> | 14,31 (143,10) | 14,31 (143,10) |

no partial packaging

INSTRUCTIONS

Store in a cool and dry place, avoiding direct exposure to sunlight and heat sources.

Please refer to the technical data sheet before the installation. For special installations, please contact our technical department.

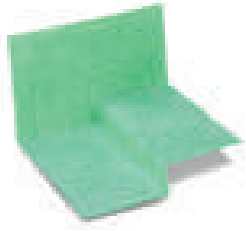

PAIG/DX/

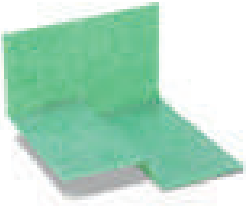

PAIG/SX/

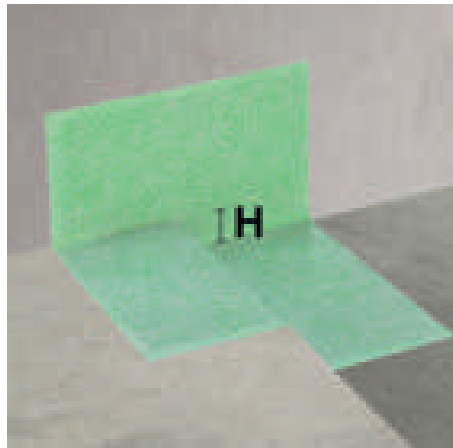

Complete the article code with DX and SX (DX = RH and SX = LH) - for example PAIG//15 RH becomes PAIG/DX/15.

For a single piece, see sales conditions on page 288

glass profile

Sanibord BP/22 and BP/25 are technical profiles in coextruded PVC to be installed between the covering and the bath tub or shower tray during the laying. These profiles allow to avoid the use of silicone and, besides the aesthetic advantages, guarantee a high hygienic level over time.



BP/22



BP/25

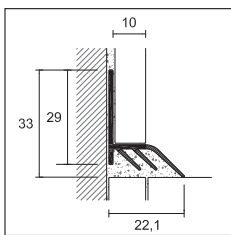

BP/22

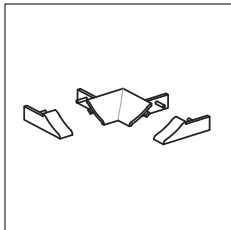

BPT/22

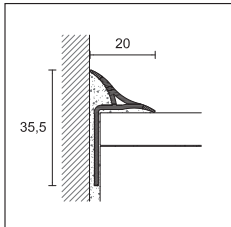

BP/25

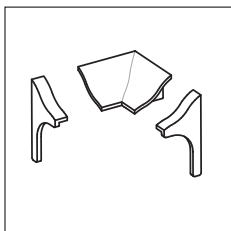

BPT/25

SANIBORD

length = 270 cm - pack 20 pcs

ART. finishing

CO-EXTRUDED PVC

| | | | |
|--------------|------------------|--------------------------|-------------|
| BP/22 | anti-mould white | <input type="checkbox"/> | 95520 |
| | <i>euro/m</i> | | 6,73 |

no partial packaging

INSIDE CORNER AND RIGHT/LEFT END CAPS FOR BP/22

pack 6 blister

ART. finishing

POLYPROPYLENE

| | | | |
|---------------|---------------------|--------------------------|-------------|
| BPT/22 | white | <input type="checkbox"/> | 95530 |
| | <i>euro/blister</i> | | 4,53 |

no partial packaging

SANIBORD

length = 270 cm - pack 20 pcs

ART. finishing

CO-EXTRUDED PVC

| | | | |
|--------------|------------------|--------------------------|-------------|
| BP/25 | anti-mould white | <input type="checkbox"/> | 95540 |
| | <i>euro/m</i> | | 6,73 |

no partial packaging

INSIDE CORNER AND RIGHT/LEFT END CAPS FOR BP/25

pack 6 blister

ART. finishing

POLYPROPYLENE

| | | | |
|---------------|---------------------|--------------------------|-------------|
| BPT/25 | white | <input type="checkbox"/> | 95545 |
| | <i>euro/blister</i> | | 4,53 |

no partial packaging

KIT: 1 PC OF 180 CM + 2 PCS OF 90 CM + 2 INSIDE CORNERS AND RIGHT/LEFT END CAPS

pack 10 pcs

ART. finishing

CO-EXTRUDED PVC

| | | | |
|---------------|------------------|--------------------------|--------------|
| BPK/25 | anti-mould white | <input type="checkbox"/> | 95494 |
| | <i>euro/kit</i> | | 32,43 |

individually packed - no partial packaging

Sanibord BH/20 and BP/20 are technical profiles in colour-coated aluminium and coextruded PVC to be installed between the covering and the bath tub or the shower tray. These profiles allow to avoid the use of silicone and, besides the aesthetic advantages, guarantee a high hygienic level over time.

BH/20 in colour-coated aluminium is provided with the certified antibacterial technology (according to the internationally recognized laboratory test JIS Z 2801:2000) which allows to reduce the presence of the most dangerous bacteria up to 99%.



BP/20 anti-mould white co-extruded PVC

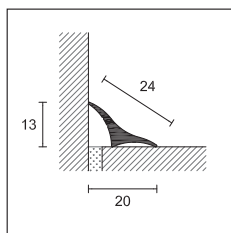

BH/20

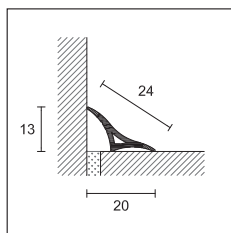

BP/20

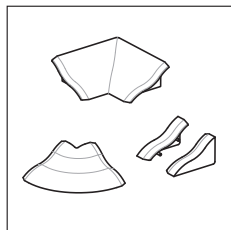

BPT/20

SANIBORD

length = 270 cm - pack 20 pcs

ART. finishing

ANTIBACTERIAL COLOUR-COATED ALUMINIUM

| | | | |
|-------------------------|--|--------------------------|-------------|
| BH/20 | colour-coated white antibacterial RAL 9003 | <input type="checkbox"/> | 95459 |
| | <i>euro/m</i> | | 8,20 |
| BH/20/A adhesive | colour-coated white antibacterial RAL 9003 | <input type="checkbox"/> | 95460 |
| | <i>euro/m</i> | | 9,27 |

SANIBORD

length = 270 cm - pack 20 pcs

ART. finishing

CO-EXTRUDED PVC

| | | | |
|-------------------------|------------------|--------------------------|-------------|
| BP/20 | anti-mould white | <input type="checkbox"/> | 95490 |
| | <i>euro/m</i> | | 4,45 |
| BP/20/A adhesive | anti-mould white | <input type="checkbox"/> | 95470 |
| | <i>euro/m</i> | | 5,86 |

no partial packaging

INSIDE CORNER, OUTSIDE CORNER, RIGHT/LEFT END CAPS FOR BH/20 AND BP/20

pack 6 blister

ART. finishing

POLYPROPYLENE

| | | | |
|---------------|---------------------|--------------------------|-------------|
| BPT/20 | white | <input type="checkbox"/> | 95480 |
| | <i>euro/blister</i> | | 6,29 |

no partial packaging

KIT: 1 PC OF 180 CM + 2 PCS OF 90 CM + 2 INSIDE CORNERS AND RIGHT/LEFT END CAPS

pack 10 pcs

ART. finishing

CO-EXTRUDED PVC

| | | | |
|---------------|------------------|--------------------------|--------------|
| BPK/20 | anti-mould white | <input type="checkbox"/> | 95544 |
| | <i>euro/kit</i> | | 27,26 |

individually packed excepted BP20 - no partial packaging

MS POLYMER-BASED ADHESIVE FOR SKIRTING BOARDS

quantity 290 ml - pack 24 pcs

ART.

| | | | |
|--------------|----------------|--------------------------|--------------|
| PP/96 | | <input type="checkbox"/> | 78301 |
| | <i>euro/pc</i> | | 18,81 |





profiles for floors of same height

The range of profiles is designed to combine different materials with elegance and simplicity. The coupling of different materials thus becomes interior style and not visual limit.

profiles for floors of same height

cerfix® proangle

Proangle is a line of profiles to finish, protect and decorate floors of same level in ceramic, marble, granite, wood or other material. It is also ideal as separation and decoration joint between floors made of different materials, as finishing and protection element for the edges of steps, platforms and worktops and as perimeter profile for the shaping of doormats. Proangle B in natural aluminium is particularly suitable where it is necessary to proceed to polishing, even deep, of marble, resin and wood surfaces.



Al/10 stainless steel AISI 304 DIN 1.4301

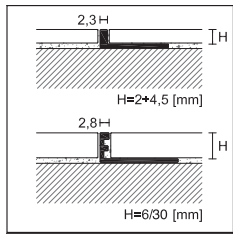

ZG/
ZA/
ZN/
ZK/

PPDESIGN

PROANGLE

length = 270 cm - pack 20 pcs

| | | H | | | | |
|------------------|-------------------|-------|-------|-------|-------|-------|
| ART. | finishing | 2 | 2,5 | 3 | 4,5 | 6 |
| ALUMINIUM | | | | | | |
| ZG/ | natural aluminium | 90207 | 90206 | 90208 | 90210 | 88159 |
| | euro/m | 2,08 | 2,08 | 2,08 | 2,23 | 2,29 |
| ZA/ | silver anodised | 90336 | 90337 | 90338 | 90340 | 88204 |
| | euro/m | 2,95 | 2,95 | 2,95 | 3,08 | 3,15 |
| BRASS | | | | | | |
| ZN/ | natural brass | - | - | 90078 | 90080 | 88024 |
| | euro/m | - | - | 7,37 | 7,53 | 7,76 |
| ZK/ | chromium plated | - | - | - | 90081 | 88114 |
| | euro/m | - | - | - | 16,93 | 17,05 |

individually packed - ZA/ H 10 and ZG/ H 8 - 10 - 12 are available in length of 90 cm euro/m + 0,42 art. ZN/22,5 pack 5 pcs

PROANGLE

length = 270 cm - pack 20 pcs

| | | H | | | |
|------------------------|---|-------|-------|-------|-------|
| ART. | finishing | 3 | 4,5 | 6 | 8 |
| STAINLESS STEEL | | | | | |
| AI/ | stainless steel AISI 304 DIN 1.4301 | 91636 | 91638 | 91642 | 91644 |
| | euro/m | 6,98 | 7,11 | 7,44 | 7,69 |
| AIS/ | satin stainless steel AISI 304 - DIN 1.4301 | - | 91671 | 91673 | 91674 |
| | euro/m | - | 8,89 | 9,23 | 9,48 |
| AIX/ | stainless steel AISI 316 DIN 1.4404 | - | - | 91684 | 91685 |
| | euro/m | - | - | 8,76 | 8,96 |

individually packed - AI/ H 10 is available in length of 90 cm euro/m + 0,42

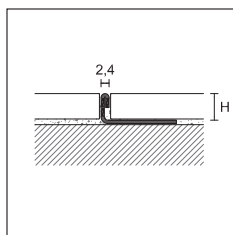

AI/
AIS/
AIX/

Profiles PROANGLE sandblasted stainless steel finish see page 96

Complete the article code with H measure (for example ZG/ for H=10 becomes ZG/10)

Items AIX/ in other heights, on demand for minimum 540 meters for each height

For a single piece, see sales conditions on page 288



ZG/10 natural aluminium



ZBG/10 natural aluminium



ZN/10 natural brass



ZK/10 chromium-plated brass

| H | | | | | | | | | | | | |
|-------|-------|-------|-------|-------|-------|-------|-------|-------|-------|-------|------|----|
| 8 | 9 | 10 | 11 | 12,5 | 14 | 15 | 17,5 | 20 | 22,5 | 25 | 27,5 | 30 |
| 88160 | 88155 | 88161 | 88156 | 88162 | 88157 | 88163 | 88164 | 88165 | 88166 | 88167 | - | - |
| 2,44 | 2,51 | 2,54 | 2,61 | 2,68 | 2,79 | 2,90 | 3,23 | 3,40 | 3,68 | 3,89 | - | - |
| 88205 | 88217 | 88206 | 88218 | 88207 | - | 88208 | 88209 | 88210 | 88211 | 88212 | - | - |
| 3,23 | 3,31 | 3,39 | 3,66 | 3,91 | - | 4,16 | 4,54 | 4,91 | 5,19 | 5,54 | - | - |
| 88025 | - | 88026 | 88038 | 88027 | - | 88028 | 88029 | 88030 | 88031 | - | - | - |
| 8,24 | - | 8,81 | 9,16 | 9,49 | - | 10,25 | 11,27 | 12,03 | 12,65 | - | - | - |
| 88115 | - | 88116 | 88118 | 88117 | - | - | - | - | - | - | - | - |
| 17,63 | - | 18,02 | 18,29 | 18,67 | - | - | - | - | - | - | - | - |

| H | | | | | | | | | | | | |
|-------|-------|-------|-------|-------|-------|-------|-------|-------|-------|-------|-------|--|
| 9 | 10 | 11 | 12,5 | 14 | 15 | 17,5 | 20 | 22,5 | 25 | 27,5 | 30 | |
| 91645 | 91646 | 91647 | 91648 | 91649 | 91650 | 91652 | 91654 | 91656 | 91658 | 91660 | 91662 | |
| 7,89 | 8,05 | 8,23 | 8,37 | 8,58 | 8,84 | 9,26 | 9,60 | 10,14 | 10,78 | 11,20 | 11,61 | |
| - | 91675 | 91677 | 91676 | - | 91678 | - | 91679 | - | - | - | - | |
| - | 9,83 | 9,99 | 10,16 | - | 11,64 | - | 13,46 | - | - | - | - | |
| - | 91686 | 91688 | 91687 | - | - | - | - | - | - | - | - | |
| - | 9,45 | 9,94 | 10,41 | - | - | - | - | - | - | - | - | |

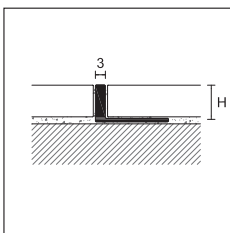

ZBG/

PROANGLE B

length = 270 cm - pack 20 pcs

| | | H | | | | | |
|------------------|-------------------|-------|-------|-------|-------|-------|-------|
| ART. | finishing | 8 | 10 | 12,5 | 15 | 20 | 22,5 |
| ALUMINIUM | | | | | | | |
| ZBG/ | natural aluminium | 90010 | 90012 | 90014 | 90016 | 90018 | 90020 |
| | euro/m | 3,20 | 3,28 | 3,58 | 3,97 | 4,61 | 4,85 |

individually packed

Complete the article code with H measure (for example ZBG/ for H=10 becomes ZBG /10)

For a single piece, see sales conditions on page 288

proflex line

Proangle is also available in the Flex version, specially studied for those situations where there is the need to curve the profile. Proangle Flex can be curved by hand or through the specific tool Proflex Machine.



AIF/10 stainless steel AISI 304 DIN 14301

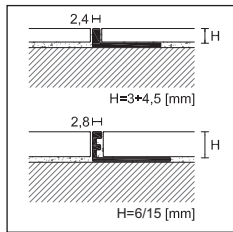

ZGF/

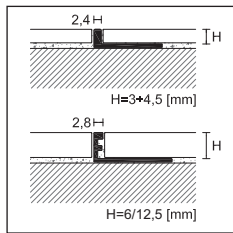

ZNF/

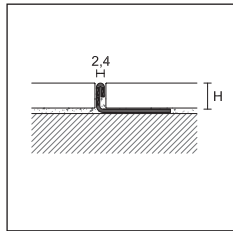

AIF/

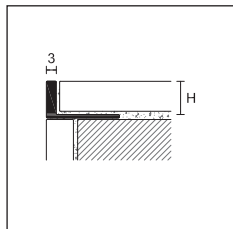

ZBGF/

PRO FLEX LINE

PROANGLE FLEX

length = 270 cm - pack 20 pcs

| | | H | | | | | | |
|------------------|-------------------|-------|-------|-------|-------|-------|-------|-------|
| ART. | finishing | 3 | 4,5 | 6 | 8 | 10 | 12,5 | 15 |
| ALUMINIUM | | | | | | | | |
| ZGF/ | natural aluminium | 88720 | 88721 | 88722 | 88723 | 88724 | 88725 | 88726 |
| | euro/m | 2,93 | 3,13 | 3,17 | 3,32 | 3,40 | 3,54 | 3,77 |

BRASS

| | | | | | | | | |
|------|---------------|-------|---|-------|-------|-------|-------|---|
| ZNF/ | natural brass | 88701 | - | 88703 | 88704 | 88705 | 88706 | - |
| | euro/m | 8,20 | - | 8,56 | 9,04 | 9,51 | 10,26 | - |

length = 270 cm - pack 10 pcs

STAINLESS STEEL

| | | | | | | | | |
|------|------------------------------------|---|---|-------|-------|-------|-------|---|
| AIF/ | stainless steel AISI 304 DIN 14301 | - | - | 91622 | 91623 | 91624 | 91625 | - |
| | euro/m | - | - | 9,14 | 9,42 | 9,79 | 10,11 | - |

Proangle Flex is available in other heights on request.

PRO FLEX LINE

PROANGLE FLEX

length = 270 cm - pack 20 pcs

| | | H | | | | | |
|------------------|-------------------|-------|-------|-------|-------|-------|-------|
| ART. | finishing | 8 | 10 | 12,5 | 15 | 20 | 22,5 |
| ALUMINIUM | | | | | | | |
| ZBGF/ | natural aluminium | 90011 | 90013 | 90015 | 90017 | 90019 | 90021 |
| | euro/m | 4,41 | 4,47 | 4,77 | 5,15 | 5,69 | 5,94 |

individually packed



Complete the article code with H measure (for example ZGF/ for H=8 becomes ZGF/8)

For a single piece, see sales conditions on page 288

PROFLEX MACHINE - hand machine to bend proflex line profiles, see page 267

Prodecor and Prodecor DJ are two lines of profiles for finishing and protecting floors of same level in ceramic, marble, granite, wood or other materials. They are also ideal as separation and decoration joints between floors made of different materials, as perimeter profiles for the shaping of doormats or as protection and finishing of platforms and ceramic steps.

The visible thickness makes the profile an elegant separation element perfectly integrated into the floor.



DJK/15 chromium-plated brass

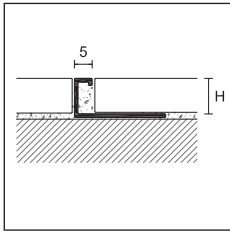

DJG/
DJA/
DJN/
DJK/

PPDESIGN

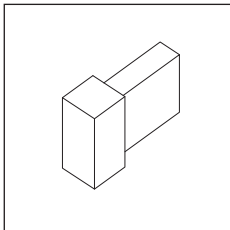

PRODECOR DJ

length = 270 cm - pack 20 pcs

| | | H | | | | |
|------------------------------|-------------------|-------|-------|-------|-------|-------|
| ART. | finishing | 8 | 10 | 12,5 | 15 | 20 |
| ALUMINIUM | | | | | | |
| DJG/ | natural aluminium | 95670 | 95672 | 95674 | - | - |
| | euro/m | 4,17 | 4,48 | 4,80 | - | - |
| DJA/ | silver anodised | 95680 | 95682 | 95684 | - | - |
| | euro/m | 5,42 | 5,70 | 6,01 | - | - |
| BRASS | | | | | | |
| DJN/ | natural brass | 95690 | 95692 | 95694 | 95691 | 95693 |
| | euro/m | 11,40 | 11,82 | 12,35 | 13,16 | 14,69 |
| CHROMIUM-PLATED BRASS | | | | | | |
| DJK/ | chromium plated | 95700 | 95702 | 95704 | 95703 | 95705 |
| | euro/m | 18,87 | 19,31 | 19,86 | 20,69 | 22,24 |

individually packed - art. DJN/20 and DJK/20 pack 10 pcs

OUTSIDE AND INSIDE CORNERS

pack 5 pcs

| | | H | | | | |
|------------------------------|-------------------|-------|-------|-------|-------|-------|
| ART. | finishing | 8 | 10 | 12,5 | 15 | 20 |
| ALUMINIUM | | | | | | |
| DJG/ /EI | natural aluminium | 95676 | 95677 | 95678 | - | - |
| | euro/pc | 5,93 | 5,93 | 5,93 | - | - |
| DJA/ /EI | silver anodised | 95686 | 95687 | 95688 | - | - |
| | euro/pc | 7,10 | 7,10 | 7,10 | - | - |
| BRASS | | | | | | |
| DJN/ /EI | natural brass | 95696 | 95697 | 95698 | 95715 | 95716 |
| | euro/pc | 10,45 | 10,45 | 10,45 | 10,45 | 10,45 |
| CHROMIUM-PLATED BRASS | | | | | | |
| DJK/ /EI | chromium plated | 95706 | 95707 | 95708 | 95709 | 95710 |
| | euro/pc | 16,15 | 16,15 | 16,15 | 16,15 | 16,15 |

no partial packaging

PRO FLEX LINE

PRODECOR DJ FLEX NEW

length = 270 cm - pack 10 pcs

| | | H | | | | |
|------------------|-----------------|---|-------|-------|----|----|
| ART. | finishing | 8 | 10 | 12,5 | 15 | 20 |
| ALUMINIUM | | | | | | |
| DJAF/ | silver anodised | - | 95685 | 95689 | - | - |
| | euro/m | - | 7,35 | 7,67 | - | - |
| BRASS | | | | | | |
| DJNF/ | natural brass | - | 95695 | 95699 | - | - |
| | euro/m | - | 13,97 | 14,49 | - | - |

individually packed

DJAF/ and DJNF/ are available in 8, 15 and 20 mm height on request, with a minimum order of 100 pcs for each code.

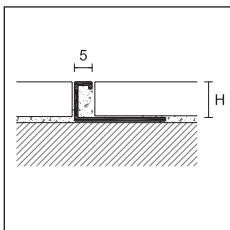

DJAF/
DJNF/

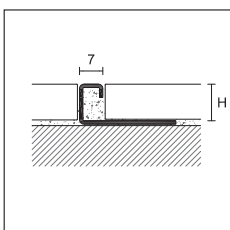

DI/

PRODECOR

length = 270 cm - pack 20 pcs

| | | H | | | | |
|------------------------|---|-------|-------|-------|-------|-------|
| ART. | finishing | 8 | 10 | 12,5 | 15 | 20 |
| STAINLESS STEEL | | | | | | |
| DI/ | polished stainless steel AISI 304 DIN 1.4301 | 95906 | 95908 | 95910 | 95911 | 95907 |
| | euro/m | 10,96 | 11,38 | 11,77 | 12,15 | 13,30 |

art. DI/20 pack 10 pcs

cerfix® prostyle

Prostyle is a line of multi-purpose profiles for the finishing and decoration of floors of same level in ceramic, marble, granite or other types of materials. It is also ideal as separation and decoration joint between floors of different materials and, in the stainless steel version, it is suitable for the protection of ceramic steps and for the surfaces subject to the passage of heavy and frequent loads.



UK/12 chromium-plated brass

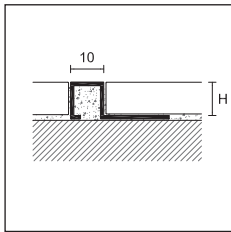

UG/
UA/
UN/
UK/

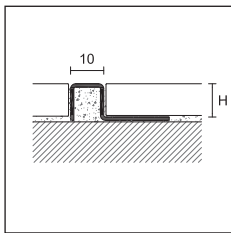

UI/
UIS/

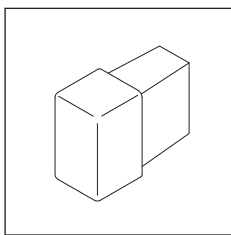

PPDESIGN

PROSTYLE

length = 270 cm - pack 20 pcs

| | | H | | | | | |
|------------------|-------------------|-------|-------|----|-------|-------|----|
| ART. | finishing | 8 | 10 | 11 | 12,5 | 15 | 20 |
| ALUMINIUM | | | | | | | |
| UG/ | natural aluminium | 93368 | 93370 | - | 93372 | 93377 | - |
| | <i>euro/m</i> | 4,91 | 5,21 | - | 5,53 | 5,97 | - |
| UA/ | silver anodised | 93378 | 93380 | - | 93382 | 93387 | - |
| | <i>euro/m</i> | 6,39 | 6,72 | - | 7,06 | 7,49 | - |

length = 270 cm - pack 10 pcs

| | | | | | | | |
|------------------------|---|-------|-------|-------|-------|-------|-------|
| STAINLESS STEEL | | | | | | | |
| UI/ | polished stainless steel AISI 304 DIN 1.4301 | 93400 | 93401 | - | 93402 | 93403 | 93404 |
| | <i>euro/m</i> | 11,82 | 12,45 | - | 13,25 | 14,06 | 15,71 |
| UIS/ | satin stainless steel AISI 304 DIN 1.4301 | 93348 | 93350 | - | 93352 | 93360 | 93361 |
| | <i>euro/m</i> | 13,74 | 14,41 | - | 15,15 | 15,97 | 17,65 |
| BRASS | | | | | | | |
| UN/ | natural brass | 93300 | 93302 | 93311 | 93304 | 93306 | 93308 |
| | <i>euro/m</i> | 13,04 | 14,94 | 15,91 | 16,75 | 17,58 | 19,36 |
| UK/ | chromium plated | 93325 | 93327 | 93312 | 93329 | 93338 | 93340 |
| | <i>euro/m</i> | 20,80 | 22,76 | 23,67 | 24,63 | 25,45 | 27,38 |

individually packed

OUTSIDE AND INSIDE CORNERS

pack 5 pcs

| | | H | | | | | |
|------------------------|---|-------|-------|-------|-------|-------|-------|
| ART. | finishing | 8 | 10 | 11 | 12,5 | 15 | 20 |
| ALUMINIUM | | | | | | | |
| UG/ /EI | natural aluminium | 93373 | 93374 | - | 93375 | 93376 | - |
| UA/ /EI | silver anodised | 93383 | 93384 | - | 93385 | 93386 | - |
| | <i>euro/pc</i> | 7,10 | 7,10 | - | 7,10 | 7,10 | - |
| STAINLESS STEEL | | | | | | | |
| UI/ /EI | polished stainless steel AISI 304 DIN 1.4301 | 93405 | 93406 | - | 93407 | 93408 | 93409 |
| | <i>euro/pc</i> | 14,81 | 14,81 | - | 14,81 | 14,81 | 14,81 |
| UIS/ /EI | satin stainless steel AISI 304 DIN 1.4301 | 93353 | 93354 | - | 93355 | 93356 | 93357 |
| | <i>euro/pc</i> | 17,07 | 17,07 | - | 17,07 | 17,07 | 17,07 |
| BRASS | | | | | | | |
| UN/ /EI | natural brass | 93301 | 93303 | 93341 | 93305 | 93307 | 93309 |
| | <i>euro/pc</i> | 15,10 | 15,10 | 15,10 | 15,10 | 15,10 | 15,10 |
| UK/ /EI | chromium plated | 93334 | 93335 | 93342 | 93336 | 93337 | 93339 |
| | <i>euro/pc</i> | 17,07 | 17,07 | 17,07 | 17,07 | 17,07 | 17,07 |

no partial packaging

Complete the article code with H measure
(for example UG/ for H=8 becomes UG/8)

For a single piece, see sales conditions on page 288

Projoint U and Projoint they are a range of separation joints in stainless steel and brass, especially suitable in case of transit of high and frequent loads. The version 799 / in case of need can be inserted and polished even after the installation after the cutting of the flooring.

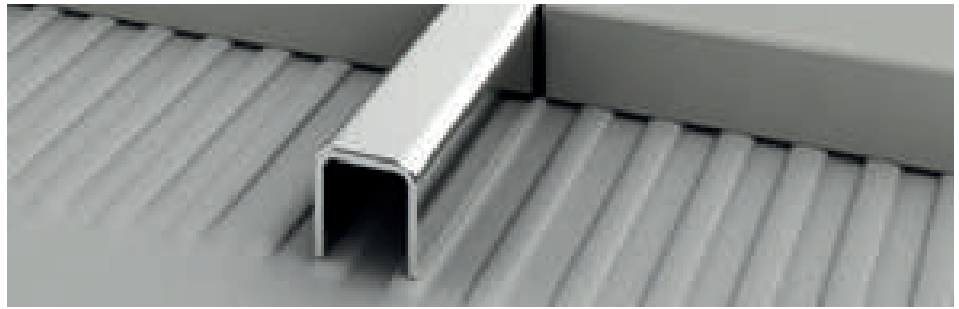

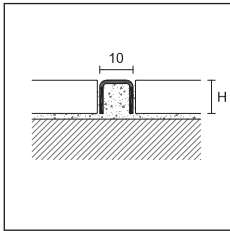

799/U/12 polished stainless steel AISI 304 DIN 1.4301



799/U/
399/U

PROJOINT U

length = 270 cm - pack 20 pcs

| H | 10 | 12,5 |
|------------------------|---|---|
| ART. finishing | | |
| STAINLESS STEEL | | |
| 799/U/ | polished stainless steel AISI 304 DIN 1.4301 |  |
| | 75078 | 75072 |
| | euro/m | 8,12 |
| BRASS | | |
| 399/U | polished brass |  |
| | 75077 | - |
| | euro/m | - |

individually packed

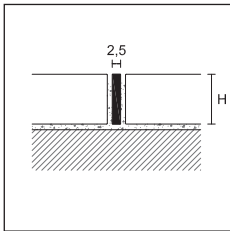

799/

PROJOINT

length = 270 cm - pack 20 pcs

| H | 10 |
|------------------------|---|
| ART. finishing | |
| STAINLESS STEEL | |
| 799/ | stainless steel AISI 304 DIN 1.4301 |
| |  |
| | 74966 |
| | euro/m |
| | 5,72 |

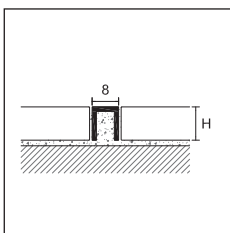

380/8

PROJOINT

length = 270 cm - pack 20 pcs

| measures LxH | 8x10 |
|-----------------------|---|
| ART. finishing | |
| BRASS | |
| 380/8 | natural brass |
| |  |
| | 75047 |
| | euro/m |
| | 14,05 |

Complete the article code with H measure (for example 799/U/ for H=10 becomes 799/U/10)

For a single piece, see sales conditions on page 288

projoint

Projoint T is a line of profiles for the separation, protection and decoration of same-level floors in ceramic, marble, granite, wood or other materials. It is also ideal to cover any imperfections due to the cutting or for the laying of floors made of different materials. Its special section allows to cover slight height differences (2÷3 mm) between two different types of floor. It is also easy to install, thanks to the arrow shape which allows a perfect fixing with sealants or adhesives.



99/T/14 silver anodised aluminium

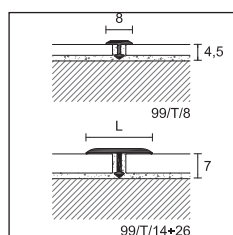

99/T/
399/T/
399/TC/

PROJOINT T

| | | | | |
|------------------------|----------|-----------|-----------|-----------|
| length = 270 cm - pack | 50 pcs | 50 pcs | 30 pcs | 20 pcs |
| width | 8 | 14 | 20 | 26 |

ART. finishing

ALUMINIUM

| | | | | | |
|--|--|-------------|-------------|-------------|-------------|
| silver anodised | | 75075 | 75080 | 63600 | 75082 |
| gold anodised | | - | 75083 | 75084 | 75085 |
| euro/m | | 3,18 | 3,50 | 3,76 | 4,61 |
| 99/T/ titanium anodised | | - | 75099 | - | - |
| euro/m | | - | 4,18 | - | - |
| colour-coated anthracite grey RAL 7016 | | - | 75091 | - | - |
| euro/m | | - | 7,04 | - | - |

| | | | | |
|------------------------|---|-----------|---|---|
| length = 270 cm - pack | - | 10 pcs | - | - |
| width | - | 14 | - | - |

ART. finishing

ALUMINIUM decors ALCROM® PLUS

| | | | | | |
|---------------------------|--|---|-------------|---|---|
| NEW 99/T/ 97 black | | - | 75095 | - | - |
| euro/m | | - | 5,33 | - | - |

individually packed

PROJOINT T

| | |
|--|-----------|
| length = 90 cm - pack 10 pcs / blister | L |
| ART. finishing | 14 |

ALUMINIUM

| | | |
|---------------------|--|-------------|
| silver anodised | | 20008 |
| 499/T gold anodised | | 20010 |
| euro/pc | | 4,14 |

PROJOINT T

| | |
|-------------------------------|-----------------|
| length = 270 cm - pack 20 pcs | LxH |
| ART. finishing | 26 X 4,5 |

ALUMINIUM

| | | |
|--------------------------|--|-------------|
| 99/TR/26 silver anodised | | 75081 |
| euro/m | | 4,57 |

individually packed

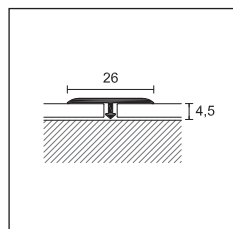

99/TR/26

PRO FLEX LINE

Projoint T 99/T/ can be bent with Proflex Machine.

Complete the article code with L measure (for example 99/T/ for L=14 becomes 99/T/14)

packaging in blister no partial packaging

For a single piece, see sales conditions on page 288

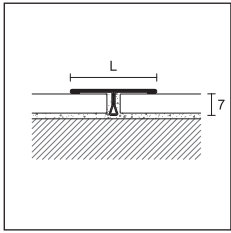

799/T/
799/TS/

PROJOINT T

| | | | | |
|------------------------|---|-----------|--------------|--------------|
| length = 270 cm - pack | | 30 pcs | 20 pcs | |
| width | | 14 | 26 | |
| ART. finishing | | | | |
| STAINLESS STEEL | | | | |
| 799/T/ | polished stainless steel AISI 304 DIN 1.4301 | | 75092 | 75096 |
| | euro/m | | 9,23 | 13,53 |
| 799/TS/ | satin stainless steel AISI 304 DIN 1.4301 | | 75093 | 75097 |
| | euro/m | | 11,56 | 16,43 |

individually packed

PROJOINT T

| | | | | |
|--|---|--|--------------|---|
| length = 90 cm - pack 10 pcs / blister | | | | |
| 4799/T | polished stainless steel AISI 304 DIN 1.4301 | | 20001 | - |
| | euro/pc | | 9,27 | - |
| 4799/TS | satin stainless steel AISI 304 DIN 1.4301 | | 20002 | - |
| | euro/pc | | 11,38 | - |

PROJOINT T

| | | | | | | |
|------------------------|-----------------|----------|--------------|--------------|--------------|--------------|
| length = 270 cm - pack | | 50 pcs | 20 pcs | 20 pcs | 20 pcs | |
| width | | 8 | 14 | 20 | 26 | |
| ART. finishing | | | | | | |
| BRASS | | | | | | |
| 399/T/ | polished | | 75070 | 75087 | 75090 | 75088 |
| | euro/m | | 6,50 | 6,74 | 10,16 | 11,85 |
| pack | | | 30 pcs | 30 pcs | - | 10 pcs |
| 399/TC/ | chromium plated | | 75071 | 75086 | - | 75089 |
| | euro/m | | 13,16 | 13,49 | - | 17,99 |

individually packed

PROJOINT T

| | | | |
|--|----------------|--|-------------|
| length = 90 cm - pack 10 pcs / blister | | | |
| 4399/T | polished | | 20016 |
| | euro/pc | | 7,19 |

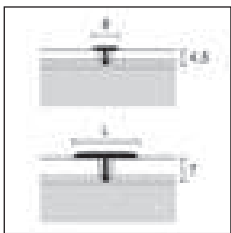

PPDESIGN

399/T/
399/TC/



799/T/26 polished stainless steel AISI 304 DIN 1.4301



399/T/14 polished brass

PROFLEX LINE

Projoint T 399/T/ and 399/TC/ can be bent with Proflex Machine.

Complete the article code with L measure (for example 799/T/ for L=14 becomes 799/T/14)

For a single piece, see sales conditions on page 288

profiles for floors of same height

projoint

Projoint R is a line of profiles for subdivision and / or decoration of floors of the same level in ceramic, marble, granite, wood or other materials. The thickness of the upper part makes it particularly suitable for the polishing of wood, marble, etc...



399/R/10 natural brass

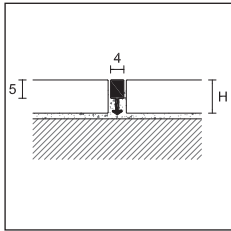

99/R/
399/R/

PROJOINT R

length = 270 cm - pack 50 pcs H

| ART. | finishing | 10 | 14 |
|------|-----------|----|----|
|------|-----------|----|----|

ALUMINIUM

| | | | | |
|-------|-------------------|---|-------------|-------------|
| 99/R/ | natural aluminium |  | 75006 | 75016 |
| | <i>euro/m</i> | | <i>2,26</i> | <i>2,75</i> |

length = 270 cm - pack 20 pcs H

BRASS

| | | | | |
|--------|---------------|---|-------------|-------------|
| 399/R/ | natural brass |  | 75007 | 75017 |
| | <i>euro/m</i> | | <i>7,63</i> | <i>8,69</i> |

length = 90 cm - pack 10 pcs 

BRASS

| | | | | |
|-----------|----------------|--|-------------|---|
| 4399/R/10 | natural brass |  | 20006 | - |
| | <i>euro/pc</i> | | <i>8,37</i> | - |

Projoint M is ideal as a separation joint and / or renovation and decoration between floors of the same level laid with glue or mortar. Used between materials of different thickness or type, it could also be polished both in the aluminium and brass version.



399/M natural brass

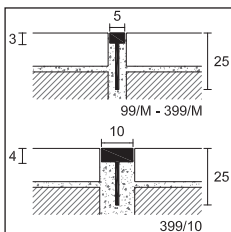

99/M
399/M
399/10

PROJOINT M

length = 270 cm - pack 50 pcs

| measures | 5x3x25 | 10x4x25 |
|----------|--------|---------|
|----------|--------|---------|

| ART. | finishing | | |
|------|-----------|--|--|
|------|-----------|--|--|

ALUMINIUM

| | | | | |
|------|-------------------|---|-------------|--------|
| 99/M | natural aluminium |  | 75005 | - |
| | <i>euro/m</i> | | <i>3,03</i> | - |
| | pack | | 20 pcs | 10 pcs |

BRASS

| | | | | |
|-------|---------------|---|-------------|---|
| 399/M | natural brass |  | 74975 | - |
| | <i>euro/m</i> | | <i>8,93</i> | - |

| | | | | |
|--------|---------------|---|---|--------------|
| 399/10 | natural brass |  | - | 74906 |
| | <i>euro/m</i> | | - | <i>16,81</i> |

Complete the article code with H measure (for example 99/R/ for H=10 becomes 99/R/10)

 packaging in blister no partial packaging

For a single piece, see sales conditions on page 288

Proclassic R is a line of profiles specially designed as threshold cover and to hide junctions and possible imperfections due to the cutting or the laying between floors of different materials. The rounded shape allows to compensate a slight height difference 2÷3 mm) between two different types of floor. The fixing is particularly easy thanks to the possibility to use adhesive or screws.



30/A silver anodised aluminium

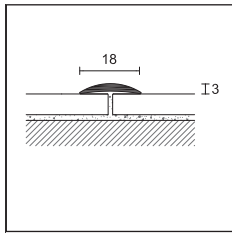

21/

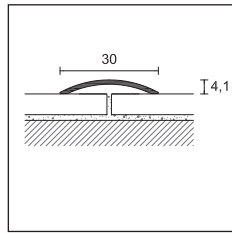

30/

PROCLASSIC R

length = 270 cm - pack 20 pcs

| ART. | finishing | A |
|------------------|-----------------|-------|
| ALUMINIUM | | |
| 21/ | silver anodised | 71037 |
| | <i>euro/m</i> | 4,69 |
| | gold anodised | 71047 |
| | <i>euro/m</i> | 4,69 |

individually packed

PROCLASSIC R

| pack | 30 pcs | | | | 10 pcs / blister | | | | | | | |
|--|--------|-------|-------|-------|------------------|-------|-------|-----|-------|-------|-------|--|
| length cm | 270 | | | | 83 | 93 | 103 | 166 | | | | |
| ART. | 30/ | | | | 430/ | | | | | | | |
| finishing | F | A | CV | AD | CV | AD | CV | AD | CV | AD | | |
| ALUMINIUM | | | | | | | | | | | | |
| silver anodised | | 71067 | 71097 | 20128 | 20148 | 20132 | 20152 | - | 20156 | 20140 | 20160 | |
| gold anodised | | 71077 | 71107 | - | - | 20133 | 20153 | - | 20157 | - | 20161 | |
| <i>euro/m</i> | | 3,65 | 4,96 | - | - | - | - | - | - | - | - | |
| <i>euro/pc</i> | | - | - | 4,26 | 5,04 | 4,60 | 5,59 | - | 6,13 | 7,86 | 9,73 | |
| titanium anodised | | - | 71098 | - | - | - | - | - | - | - | - | |
| <i>euro/m</i> | | - | 5,50 | - | - | - | - | - | - | - | - | |
| <i>euro/pc</i> | | - | - | - | - | - | - | - | - | - | - | |
| bronze anodised | | - | 71117 | - | - | - | 20154 | - | - | - | - | |
| <i>euro/m</i> | | - | 4,96 | - | - | - | - | - | - | - | - | |
| <i>euro/pc</i> | | - | - | - | - | - | 5,59 | - | - | - | - | |
| colour-coated anthracite grey RAL 7016 | | - | 71101 | - | - | - | - | - | - | - | - | |
| <i>euro/m</i> | | - | 8,99 | - | - | - | - | - | - | - | - | |

individually packed

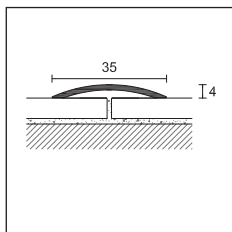

35/

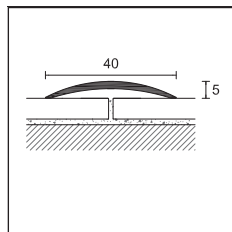

41/

PROCLASSIC R

length = 270 cm - pack 20 pcs

| ART. | 35/ | |
|------------------|-----|-------|
| finishing | F | A |
| ALUMINIUM | | |
| silver anodised | | 71387 |
| <i>euro/m</i> | | 4,68 |
| | | 71417 |
| | | 5,96 |

individually packed

PROCLASSIC R

| pack | 20 pcs | | 10 pcs / blister |
|-------------------|--------|-------|------------------|
| length cm | 270 | | 90 |
| ART. | 41/ | | 441/ |
| finishing | F | A | AD |
| ALUMINIUM | | | |
| silver anodised | | 71587 | 71617 |
| gold anodised | | - | 71627 |
| <i>euro/m</i> | | 5,57 | 6,85 |
| <i>euro/pc</i> | | - | 7,29 |
| titanium anodised | | - | 71618 |
| <i>euro/m</i> | | - | 7,54 |
| <i>euro/pc</i> | | - | 7,99 |
| bronze anodised | | - | 71637 |
| <i>euro/m</i> | | - | 6,85 |
| <i>euro/pc</i> | | - | - |

individually packed

Complete the article code with F= drilled, A-A-D=adhesive, CV=with screws (for example 30/ becomes 30/F)

packaging in blister no partial packaging

For a single piece, see sales conditions on page 288

proclassic

Proclassic R in stainless steel is particularly suitable in public spaces and in the case of passage of frequent and heavy loads. The sparkle of polished stainless steel also matches perfectly the modern floors and furnishings.

Proclassic R in polished brass is classic and modern at the same time and can be easily combined to handles, taps and other furniture accessories of the same material and finish.



720/A polished stainless steel AISI 430 DIN 1.4016

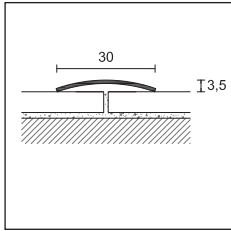

720/
722/
020/

PROCLASSIC R

| | | | | | | | | | | | | | |
|---|-------------|-------------|-------------|-------------|-------------|-------------|-------|-------|-------|-------|-------|-------|--|
| pack | 20 pcs | PRO | | | | | | | | | | | |
| length cm | 270 | 73 | 83 | 93 | 103 | 166 | | | | | | | |
| ART. | 720/ | 720/ | | | | | | | | | | | |
| finishing | F A | F A | F A | F A | F A | F A | F A | F A | F A | F A | F A | F A | |
| STAINLESS STEEL (thickness 10/10) | | | | | | | | | | | | | |
| polished stainless steel AISI 430 - DIN 1.4016 | 71287 71297 | 71280 71290 | 71281 71291 | 71282 71292 | - | - | - | - | - | - | - | 71294 | |
| euro/m | 3,41 4,97 | - | - | - | - | - | - | - | - | - | - | - | |
| euro/pc | - | 2,50 3,64 | 2,85 4,14 | 3,19 4,65 | - | - | - | - | - | - | - | 8,26 | |
| 10 pcs / blister | | | | | | | | | | | | | |
| ART. | 4720/ | | | | | | | | | | | | |
| finishing | | CV AD | CV AD | CV AD | CV AD | CV AD | CV AD | CV AD | CV AD | CV AD | CV AD | CV AD | |
| polished stainless steel AISI 430 - DIN 1.4016 | - - | 20287 20293 | 20288 20294 | 20289 20295 | 20290 20296 | 20291 20297 | | | | | | | |
| euro/pc | - - | 4,18 4,98 | 4,59 5,54 | 4,92 6,01 | 5,34 6,60 | 8,23 10,44 | | | | | | | |
| satin stainless steel AISI 430 - DIN 1.4016 | - 71298 | - - | - - | - - | - - | - - | | | | | | | |
| euro/m | - 5,87 | - - | - - | - - | - - | - - | | | | | | | |

individually packed

PROCLASSIC R

| | | | | | | | | | | | | | |
|--|---------|------------------|-------|---------|-------|-------|-------|-------|-------|-------|-------|-------|--|
| pack | 20 pcs | 10 pcs / blister | | | | | | | | | | | |
| length cm | 270 | 73 | 83 | 93 | 103 | 166 | | | | | | | |
| ART. | 722/ | 4722/ | | | | | | | | | | | |
| finishing | - A | CV AD | CV AD | CV AD | CV AD | CV AD | CV AD | CV AD | CV AD | CV AD | CV AD | CV AD | |
| STAINLESS STEEL (thickness 10/10) | | | | | | | | | | | | | |
| satin stainless steel AISI 304 - DIN 1.4301 | - 71268 | - - | - - | - 20300 | - - | - - | | | | | | | |
| euro/m | - 8,15 | - - | - - | - - | - - | - - | | | | | | | |
| euro/pc | - - | - - | - - | - 8,51 | - - | - - | | | | | | | |

individually packed

PROCLASSIC R

| | | | | | | | | | | | | | |
|--------------------------------|-------------|------------------|-------------|-------------|-------------|-------------|-------|-------|-------|-------|-------|-------|--|
| pack | 20 pcs | 10 pcs / blister | | | | | | | | | | | |
| length cm | 270 | 73 | 83 | 93 | 103 | 166 | | | | | | | |
| ART. | 020/ | 4020/ | | | | | | | | | | | |
| finishing | F A | CV AD | CV AD | CV AD | CV AD | CV AD | CV AD | CV AD | CV AD | CV AD | CV AD | CV AD | |
| BRASS (thickness 10/10) | | | | | | | | | | | | | |
| polished | 71187 71207 | 20207 20213 | 20208 20214 | 20209 20215 | 20210 20216 | 20211 20217 | | | | | | | |
| euro/m | 6,99 8,66 | - - | - - | - - | - - | - - | | | | | | | |
| euro/pc | - - | 6,54 7,45 | 7,35 8,31 | 8,02 9,27 | 8,85 10,19 | 13,87 16,21 | | | | | | | |

individually packed



020/A polished brass

Complete the article code with F= drilled, A=adhesive, CV=with screws (for example 720/drilled becomes 720/F)

packaging in blister no partial packaging

For a single piece, see sales conditions on page 288

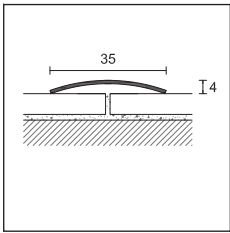

726/

PROCLASSIC R

| | | | | | |
|-----------|--------|------|-----|-----|--|
| pack | 20 pcs | PRO | | | |
| length | 270 | 83 | 93 | 166 | |
| ART. | 726/ | 726/ | | | |
| finishing | F A | F A | F A | F A | |

STAINLESS STEEL (thickness 10/10)

| | | | | | | | | | |
|---|--|-------|-------|---|---|-------|-------|---|---|
| polished stainless steel AISI 430 - DIN 1.4016 | | 71507 | 71517 | - | - | 71502 | 71512 | - | - |
| euro/m | | 5,10 | 6,35 | - | - | - | - | - | - |
| euro/pc | | - | - | - | - | 4,74 | 5,92 | - | - |

10 pcs / blister

| | | | | | | | |
|---|-------|----|-------|-------|-------|----|-------|
| ART. | 4726/ | | | | | | |
| finishing | | CV | AD | CV | AD | CV | AD |
| polished stainless steel AISI 430 - DIN 1.4016 | | - | 26016 | 26010 | 26017 | - | 26019 |
| euro/pc | | - | 6,15 | 5,91 | 6,85 | - | 11,99 |

satin stainless steel
AISI 430 - DIN 1.4016

| | | | | | | | |
|---------------|--|---|-------|---|---|---|---|
| | | - | 71518 | - | - | - | - |
| euro/m | | - | 7,42 | - | - | - | - |

individually packed

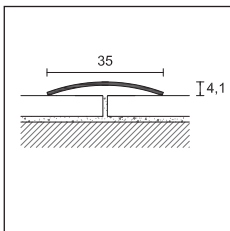

026/

PROCLASSIC R

| | | |
|------------------------------|--------|------------------|
| pack | 20 pcs | 10 pcs / blister |
| thickness =10/10 - length cm | 270 | 93 |
| ART. | 026/ | 4026/ |
| finishing | F A | CV AD |

BRASS (thickness 10/10)

| | | | | | |
|----------------|--|-------|-------|-------|-------|
| polished | | 71447 | 71457 | 20409 | 20415 |
| euro/m | | 9,29 | 11,19 | - | - |
| euro/pc | | - | - | 10,38 | 11,79 |

individually packed

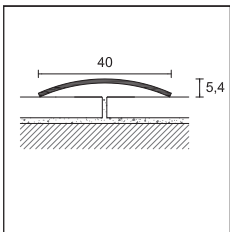

729/

PROCLASSIC R

| | | |
|-----------|--------|-----------------|
| pack | 20 pcs | 5 pcs / blister |
| length | 270 | 93 |
| ART. | 729/ | 4729/ |
| finishing | F A | CV AD |

STAINLESS STEEL (thickness 12/10)

| | | | | | |
|---|--|-------|-------|---|-------|
| polished stainless steel AISI 430 - DIN 1.4016 | | 71667 | 71677 | - | 40220 |
| euro/m | | 7,50 | 8,89 | - | - |
| euro/pc | | - | - | - | 9,31 |
| satin stainless steel AISI 430 - DIN 1.4016 | | - | 71678 | - | - |
| euro/m | | - | 10,47 | - | - |

individually packed

Complete the article code with F= drilled, A-A-D=adhesive, CV=with screws (for example 726/ drilled becomes 726/F)

packaging in blister no partial packaging

For a single piece, see sales conditions on page 288



722/A satin stainless steel AISI 304 DIN 1.4301

proclassic

Proclassic F is a line of threshold cover profiles with a thickness that allows the application under the doors. 19/ and 25/ are provided with a useful non-slip knurled surface. The installation is particularly simple, thanks to the possibility to use adhesive or screws.

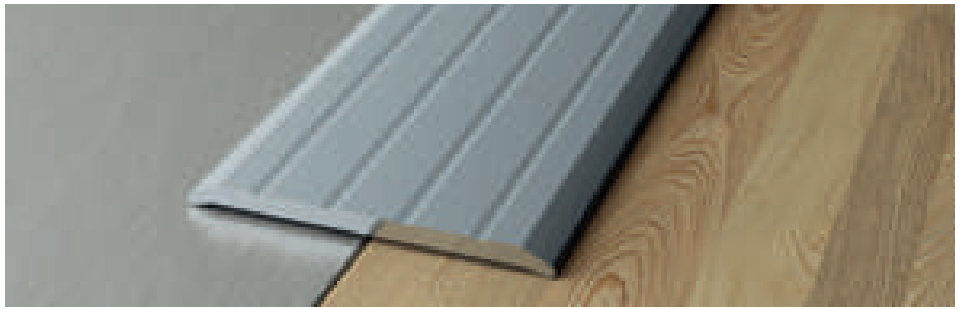

25/A silver anodised aluminium

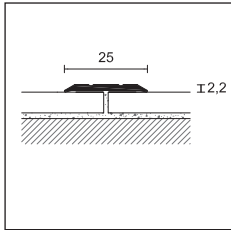

19/

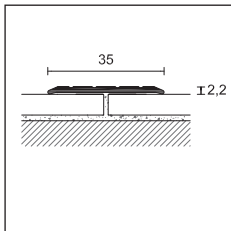

25/

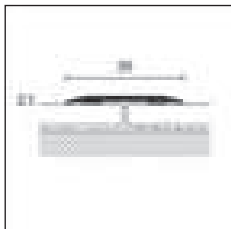

22/A
422/AD





Complete the article code with F=drilled, A/AD=adhesive, CV=with screws (for example 19/F)

NEW

 packaging in blister no partial packaging





For a single piece, see sales conditions on page 288

PROCLASSIC F

| | | | | |
|------------------|---|-------|--|-------|
| pack | 30 pcs | | 10 pcs / blister  | |
| length cm | 270 | | 93 | |
| ART. | 19/ | | 419/ | |
| finishing | F | A | CV | AD |
| ALUMINIUM | | | | |
| silver anodised |  71867 | 71897 | 27074 | 27092 |
| euro/m | 3,43 | 4,60 | - | - |
| euro/pc | - | - | 4,31 | 5,21 |
| gold anodised |  - | 71907 | 27080 | 27099 |
| euro/m | - | 4,60 | - | - |
| euro/pc | - | - | 4,31 | 5,21 |
| bronze anodised |  - | 71917 | - | - |
| euro/m | - | 4,60 | - | - |
| euro/pc | - | - | - | - |



individually packed

PROCLASSIC F

| | | | | | |
|------------------|---|-------|-------|--|-------|
| pack | 20 pcs | | | 10 pcs / blister  | |
| length cm | 270 | | | 93 | |
| ART. | 25/ | | | 425/ | |
| finishing | F | D | A | CV | AD |
| ALUMINIUM | | | | | |
| silver anodised |  71947 | 71948 | 71977 | 22533 | 22553 |
| euro/m | 4,24 | 4,24 | 5,54 | - | - |
| euro/pc | - | - | - | 5,07 | 5,96 |
| gold anodised |  71957 | - | 71987 | 22534 | 22554 |
| euro/m | 4,24 | - | 5,54 | - | - |
| euro/pc | - | - | - | 5,07 | 5,96 |
| bronze anodised |  - | - | 71997 | - | 22555 |
| euro/m | - | - | 5,54 | - | - |
| euro/pc | - | - | - | - | 5,96 |

individually packed

PROCLASSIC F

| | | | | |
|------------------|---|-------|--|--|
| pack | 10 pcs | | 10 pcs / blister  | |
| length cm | 270 | | 90 | |
| ART. | 22/A | | 422/AD | |
| finishing | | | | |
| ALUMINIUM | | | | |
| silver |  44000 | 43790 | | |
| euro/m | 5,58 | - | | |
| euro/pc | - | 6,43 | | |
| titanium |  44001 | 43791 | | |
| euro/m | 6,55 | - | | |
| euro/pc | - | 7,28 | | |



ALUMINIUM - decors ALCROM® PLUS

| | | | | |
|----------|---|---|--|--|
| black 97 |  43996 | - | | |
| euro/m | 8,12 | - | | |
| euro/pc | - | - | | |

Wood-effect decors available on page 182 and 183





PROCLASSIC F

| | | | | | |
|---|---------------|---------------|---------------|--|----------------------------------|
| pack | 20 pcs | | | 10 pcs / blister  | 10 pcs |
| length cm | 270 | | | 90 | 270 |
| measures LxH | 15x1,8 | 20x1,8 | 30x2,5 | 30x2,5 | 40x2,5 thickness 10/10 |
| ART. | 723/A | 724/A | 730/A | 4730/AD | 740/A |
| STAINLESS STEEL | | | | | |
| polished stainless steel AISI 430 - DIN 1.4016  | 71717 | 71777 | 72117 | 20692 | 72377 |
| euro/m | 5,49 | 5,94 | 6,38 | - | 9,20 |
| euro/pc | - | - | - | 6,38 | - |

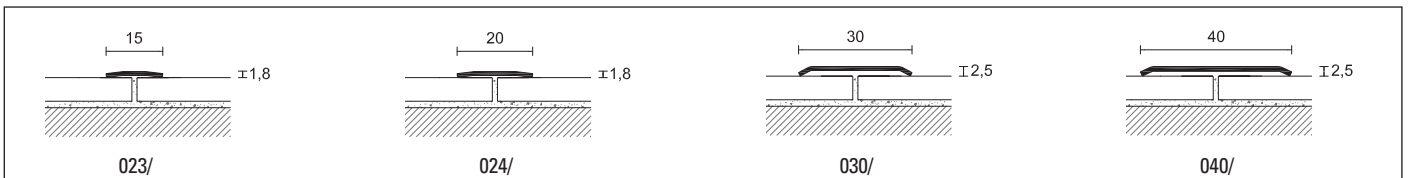
art. 723/ no individually packed - art. 730/ and 740/ individually packed



PROCLASSIC F

| | | | | | |
|--|---------------|---------------|---------------|--|---------------|
| pack | 20 pcs | | | 10 pcs / blister  | 10 pcs |
| thickness 10/10 - length cm | 270 | | | 90 | 270 |
| measures LxH | 15x1,8 | 20x1,8 | 30x2,5 | 30x2,5 | 40x2,5 |
| ART. | 023/A | 024/A | 030/A | 4030/AD | 040/A |
| BRASS | | | | | |
| polished  | 71697 | 71757 | 72057 | 20612 | 72317 |
| euro/m | 9,14 | 10,09 | 10,37 | - | 13,07 |
| euro/pc | - | - | - | 11,09 | - |

art. 030/ and 040/ individually packed - art. 023/ and 024/ not individually packed



 packaging in blister no partial packaging

For a single piece, see sales conditions on page 288 22/A aluminium covered with Alcrom® Plus black 97





profiles for floors of different height

The range of profiles for floors of different height is made with a sloping section and allows to connect floors with different thicknesses. Products made of stainless steel, brass or aluminium, are chosen according to the target environment.

cerfix® pronivel

Pronivel NZS / is a line of connection between floors of different level composed by a bearing profile and two connection wings of different size. Together the two pieces allow the elimination of the step between floors of different thickness. The articulated connector permits many combinations and the laying of a new flooring on the side of the connector , even after the application of NZS /.

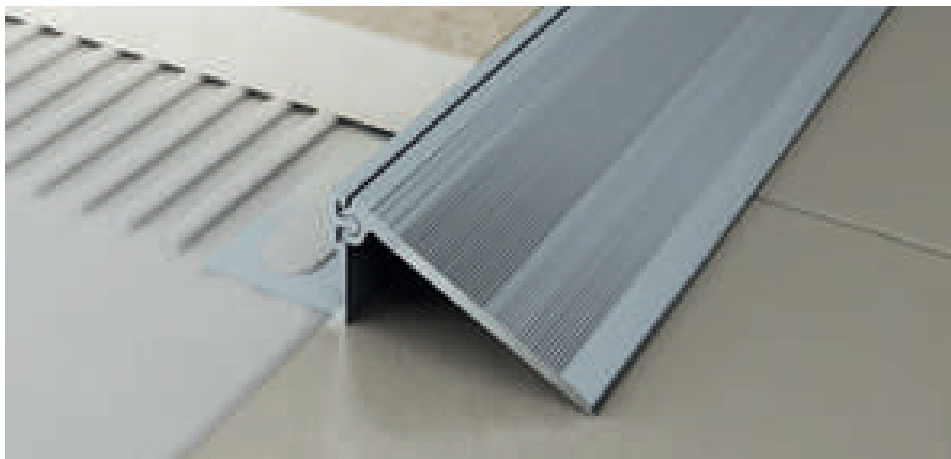

NZS/B/12 + NZS/S2 silver anodised aluminium

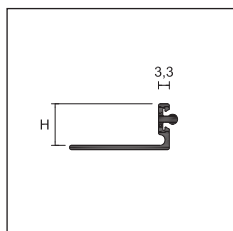

NZS/B/

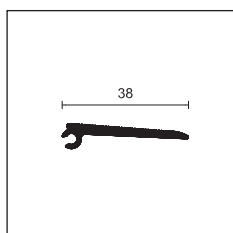

NZS/S1

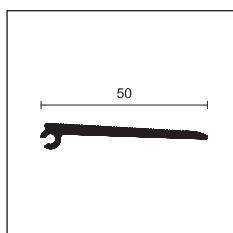

NZS/S2

PRONIVEL N

length = 270 cm - pack 10 pcs

| | | H | | | |
|------------------|----------------------------|-------|-------|-------|-------|
| ART. | finishing | 10 | 12,5 | 15 | 20 |
| ALUMINIUM | | | | | |
| NZS/B/ | silver anodised | 99905 | 99906 | 99907 | 99908 |
| | euro/m | 7,77 | 8,00 | 8,42 | 8,97 |
| | | L | | | |
| | | 38 | 50 | | |
| NZS/S1 | connection silver anodised | 99900 | - | | |
| NZS/S2 | connection silver anodised | - | 99901 | | |
| | euro/m | 9,69 | 11,19 | | |

individually packed

| | | |
|-----------------|---------------------|---------------------|
| | | |
| art. NZS/B/10 | art. NZS/S1 | art. NZS/S2 |
| 10 | 38,5 | 51 |
| | → +7 0 → -15 | → +5 0 → -25 |
| 12,5 | 38 | 50,5 |
| art. NZS/B/12,5 | | |
| | → +10 0 → -12 | → +5 0 → -23 |
| 15 | 37 | 50 |
| art. NZS/B/15 | | |
| | → +10 0 → -10 | → +6 0 → -21 |
| 20 | 35 | 48 |
| art. NZS/B/20 | | |
| | → +18 0 → -5 | → +15 0 → -15 |

Complete the article code with H measure (eg. NZS/B/ for H=10 becomes NZS/B/10)

For a single piece, see sales conditions on page 288

Pronivel P is a line of profiles to be applied during the laying of ceramic or marble flooring and suitable for connect different thicknesses. The versions in stainless steel and brass are suitable to withstand heavy stress.

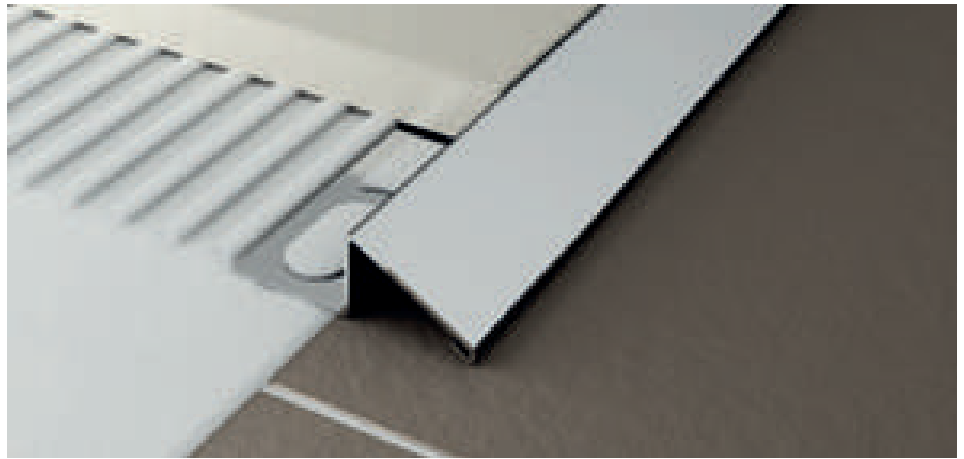

PNI/10 polished stainless steel AISI 304 DIN 1.4301

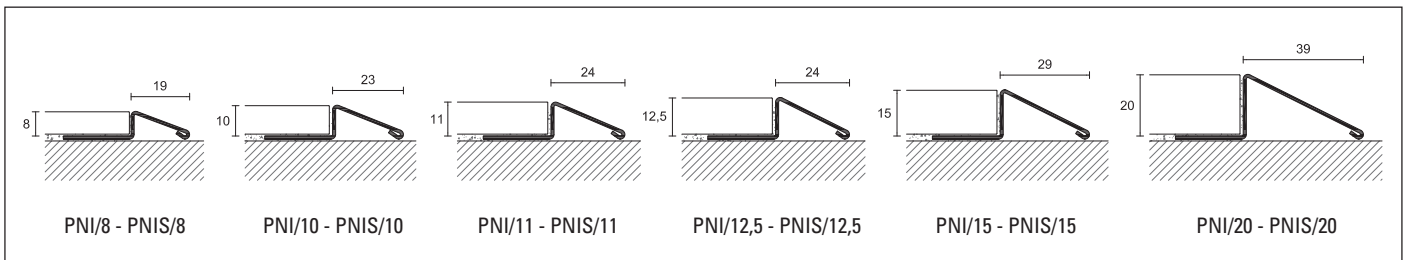
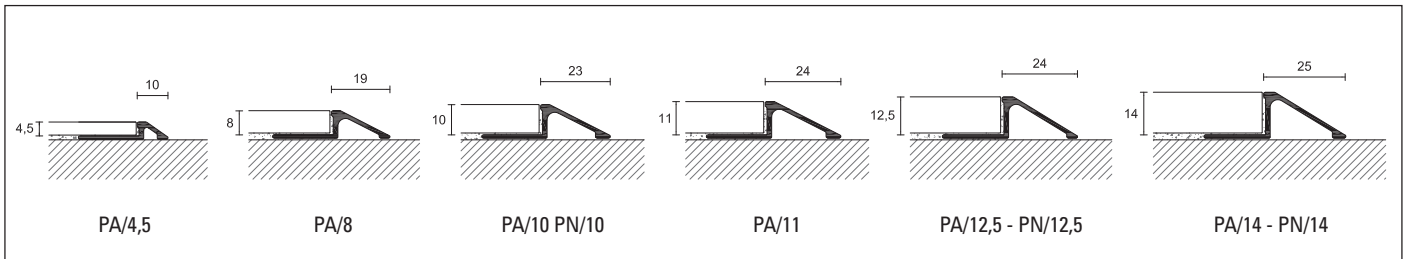

PRONIVEL P

length = 270 cm - pack 10 pcs

| | | H | | | | | | | |
|------------------------|---|-------|-------|-------|-------|-------|-------|-------|-------|
| ART. | finishing | 4,5 | 8 | 10 | 11 | 12,5 | 14 | 15 | 20 |
| ALUMINIUM | | | | | | | | | |
| PA/ | silver anodised | 93175 | 93181 | 93182 | 93185 | 93183 | 93184 | - | - |
| | <i>euro/m</i> | 5,59 | 5,89 | 6,32 | 6,72 | 6,99 | 7,35 | - | - |
| STAINLESS STEEL | | | | | | | | | |
| PNI/ | polished stainless steel AISI 304 DIN 1.4301 | - | 93092 | 93094 | 93090 | 93096 | - | 93098 | 93100 |
| | <i>euro/m</i> | - | 12,35 | 13,38 | 14,11 | 14,88 | - | 15,63 | 17,87 |
| PNIS/ | satin stainless steel AISI 304 DIN 1.4301 | - | 93093 | 93095 | 93091 | 93097 | - | 93099 | 93101 |
| | <i>euro/m</i> | - | 12,85 | 15,93 | 16,54 | 17,18 | - | 18,27 | 20,49 |
| BRASS | | | | | | | | | |
| PN/ | natural brass | - | - | 93122 | - | 93123 | - | - | - |
| | <i>euro/m</i> | - | - | 17,35 | - | 21,61 | - | - | - |

individually packed

Complete the article code with H measure (eg. PA/ for H=8 becomes PA/8)

For a single piece, see sales conditions on page 288

profiles for floors of different height

cerfix® pronivel

Pronivel L is a profile suitable to connect floors of different heights. Applicable on flooring already laid, it is fixed to the floor with adhesive.



45/SF silver anodised aluminium

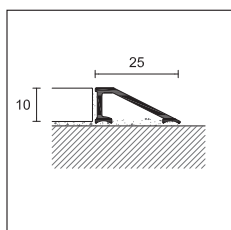

45/

PRONIVEL L

length = 270 cm - pack 20 pcs

ART. finishing

H

10

SF

A

ALUMINIUM

| | | | | |
|-----|-----------------|---|-------------|-------------|
| 45/ | silver anodised |  | 73550 | 73552 |
| | <i>euro/m</i> | | 5,50 | 6,76 |

individually packed

Pronivel PB is a transition profile between two floors subject to stress. The slight slope makes easier the passing of trolleys or wheelchairs.



PBA/10 silver anodised aluminium

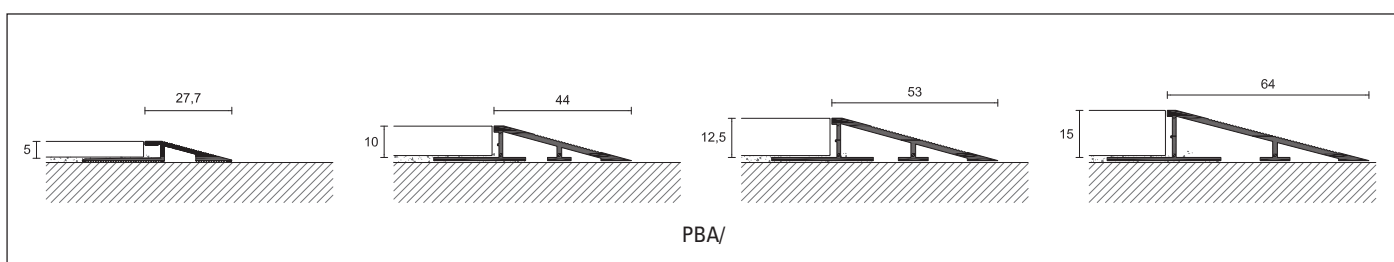

PBA/

PRONIVEL PB

length = 270 cm - pack 10 pcs

ART. finishing

5

10

12,5

15

H

ALUMINIUM

| | | | | | | |
|------|-----------------|---|-------------|--------------|--------------|--------------|
| PBA/ | silver anodised |  | 93204 | 93206 | 93208 | 93210 |
| | <i>euro/m</i> | | 7,78 | 15,46 | 17,77 | 20,40 |

individually packed

Complete the article code with SF=undrilled, A=adhesive, (eg. 45/ adhesive becomes 45/A)

Complete the article code with H measure (eg. PBA/ for H=10 becomes PBA/10)

For a single piece, see sales conditions on page 288

Pronivel Flex is a line of bendable profiles for the connection of different level floors. These profiles can be curved through our Proflex Machine and the specific wheels kit.



PLAF/10 silver anodised aluminium

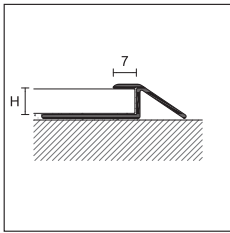

PLAF/

PRO FLEX LINE

PRONIVEL FLEX

length = 270 cm - pack 10 pcs

| | | H | | |
|------------------|-----------------|-------|-------|--|
| ART. | finishing | 8 | 10 | |
| ALUMINIUM | | | | |
| PLAF/ | silver anodised | 93190 | 93192 | |
| | euro/m | 8,56 | 9,90 | |

individually packed

Pronivel M is a line of profiles designed to connect during installation floors of different heights. The special section is effective in case of connection with carpet or LVT.



MIN/10 polished stainless steel AISI 304 DIN 1.4301

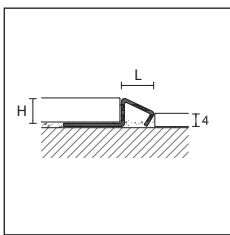

MIN/

PRONIVEL M

length = 270 cm - pack 10 pcs

| | | H | | |
|------------------------|--|-------|-------|------|
| ART. | finishing | 8 | 10 | 12,5 |
| STAINLESS STEEL | | | | |
| MIN/ | polished stainless steel AISI 304 DIN 1.4301 | 93023 | 93024 | - |
| | euro/m | 10,12 | 11,12 | - |

individually packed

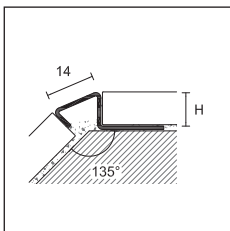

MIN/

Complete the article code with H measure (for example PLAF/ for H=8 becomes PLAF/8)

Complete the article code with H measure (for example MIN/ for H=10 becomes MIN/10)

For a single piece, see sales conditions on page 288

prolevel

Prolevel 61/ is a line of profiles to be applied after the installation, and can compensate for differences in height between 6.5 and 13 mm.



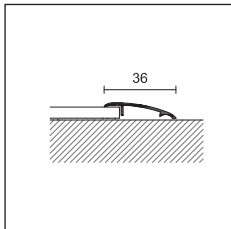

61/A silver anodised aluminium



61/

PROLEVEL HIGH

| | | |
|---|--------|--|
| pack | 20 pcs | 10 pcs / blister  |
| length cm | 270 | 90 |
| ART. | 61/ | 461/ |
| finishing | A | AD |
| ALUMINIUM | | |
| silver anodised  | 73437 | 21200 |
| euro/m | 5,84 | - |
| euro/pc | - | 6,20 |

art. 61/ individually packed

Prolevel High 55/ and 57/ are two profiles in aluminium that allows to remove the small step between two floors with a respective difference in height of 8 and 12 mm. Available also in blister pack and with adhesive, they can be easily used in DIY installations.



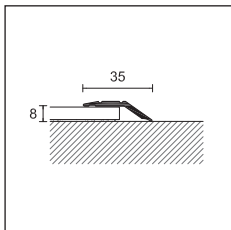

57/A silver anodised aluminium



55/

PROLEVEL HIGH

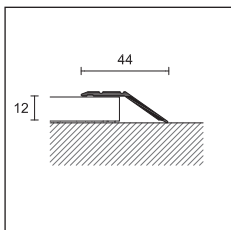

| | | | | |
|---|--------|--|-------|-------|
| pack | 20 pcs | 10 pcs / blister  | | |
| length cm | 270 | 90 | | |
| ART. | 55/ | 455/ | | |
| finishing | F | A | CV | AD |
| ALUMINIUM | | | | |
| silver anodised  | 73907 | 73937 | 42312 | 42330 |
| gold anodised  | - | 73947 | - | 42336 |
| euro/m | 6,86 | 8,10 | - | - |
| euro/pc | - | - | 7,28 | 8,20 |

art. 55/ individually packed



57/

PROLEVEL HIGH

| | | | | |
|---|--------|--|-------|-------|
| pack | 20 pcs | 10 pcs / blister  | | |
| length cm | 270 | 90 | | |
| ART. | 57/ | 457/ | | |
| finishing | F | A | CV | AD |
| ALUMINIUM | | | | |
| silver anodised  | 73967 | 73997 | 42352 | 42370 |
| gold anodised  | - | 74007 | - | 42376 |
| euro/m | 7,67 | 8,91 | - | - |
| euro/pc | - | - | 8,04 | 8,91 |

art. 57/ individually packed

Complete the item code with F=drilled, A-AD=adhesive, CV=screws (eg. 61/ adhesive becomes 61/A)

 packaging in blister no partial packaging

For a single piece, see sales conditions on page 288

Prolevel 711/ and 311/ are a line of self-adhesive stainless steel and polished brass profiles which allows the elimination of the step between floors with 7 or 12 mm slope. Available also in blister pack and self-adhesive, they are easily applicable in DIY field.



711/A polished stainless steel AISI 430 - DIN 1.4016

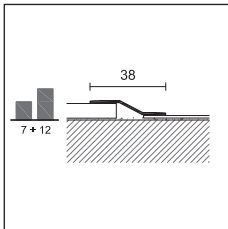

711/
311/

PROLEVEL HIGH

| | | | |
|---|--------|------------------|-------|
| pack | 20 pcs | 10 pcs / blister | |
| length cm | 270 | 83 | 93 |
| ART. | 711/ | 4711/ | |
| finishing | A | AD | AD |
| STAINLESS STEEL | | | |
| polished stainless steel AISI 430 - DIN 1.4016 | 73627 | 40431 | 40432 |
| euro/m | 8,49 | - | - |
| euro/pc | - | 8,12 | 8,96 |
| satin stainless steel AISI 430 - DIN 1.4016 | 73628 | - | - |
| euro/m | 10,00 | - | - |
| ART. | 311/ | 4311/ | |
| finishing | A | AD | AD |
| BRASS | | | |
| polished | 73607 | - | 22656 |
| euro/m | 13,10 | - | - |
| euro/pc | - | - | 13,57 |

art. 711/ and 311/ individually packed

Prolevel 712/ and 312/ are a line of self-adhesive stainless steel and polished brass profiles which allows the elimination of the step between floors with 12 or 16 mm slope. Available also in blister pack and self-adhesive, they are easily applicable in DIY field.



312/A polished brass

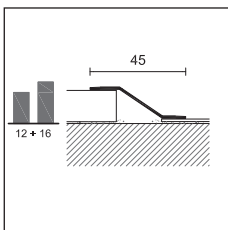

712/
312/

PROLEVEL HIGH

| | | | |
|---|--------|-----------------|--|
| pack | 10 pcs | 5 pcs / blister | |
| length cm | 270 | 90 | |
| ART. | 712/ | 4712/ | |
| finishing | A | AD | |
| STAINLESS STEEL | | | |
| polished stainless steel AISI 430 - DIN 1.4016 | 73637 | 40898 | |
| euro/m | 12,99 | - | |
| euro/pc | - | 12,75 | |
| ART. | 312/ | 4312/ | |
| finishing | A | AD | |
| BRASS | | | |
| polished | 73617 | 40868 | |
| euro/m | 19,67 | - | |
| euro/pc | - | 19,67 | |

art. 712/ e 312/ individually packed

Complete the item code with A - AD=adhesive (eg. 711/ adhesive becomes 711/A) - packaging in blister no partial packaging
For a single piece, see sales conditions on page 288

prolevel

Prolevel High 732/ is a line of profiles for the protection of the perimetral border of floors. Available in stainless steel, it can be also used as stair nosing.



732/SF/10 polished stainless steel AISI 430 DIN 1.4016

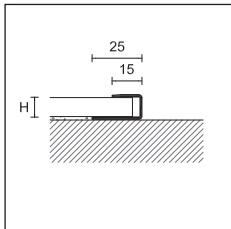

732/SF/

PROLEVEL HIGH

length = 270 cm - pack 15 pcs

| ART. | finishing | 10 | 12,5 | 15 |
|------------------------|---|-------|-------|-------|
| STAINLESS STEEL | | | | |
| 732/SF/ | polished stainless steel AISI 430 DIN 1.4016 | 74217 | 74227 | 74237 |
| | <i>euro/m</i> | 11,19 | 12,20 | 12,20 |

individually packed

Prolevel 700/, 300/ and 10/ are a line of transition profiles for floors of small thickness already laid. Available in different widths and also in blister pack, self-adhesive and with screws, they are easily applicable in DIY field.



700/A polished stainless steel AISI 430 DIN 1.4016

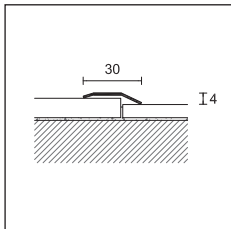

700/
300/

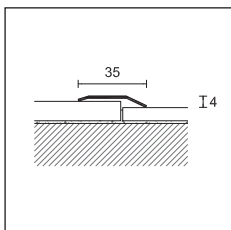

701/

PROLEVEL MEDIUM

| pack | 20 pcs | | 10 pcs / blister |
|---|--------|---------|------------------|
| length cm | 270 | 270 | 93 |
| ART. | 700/ | 701/ | 4701/ |
| finishing | A | F A | AD |
| STAINLESS STEEL | | | |
| polished stainless steel AISI 430 DIN 1.4016 | 72877 | - 72957 | 21135 |
| <i>euro/m</i> | 5,91 | - 6,72 | - |
| <i>euro/pc</i> | - | - | 7,23 |

art. 700/ and 701/ individually packed

PROLEVEL MEDIUM

| pack | 20 pcs | 10 pcs / blister |
|----------------|--------|------------------|
| length cm | 270 | 93 |
| ART. | 300/ | 4300/ |
| finishing | A | AD |
| BRASS | | |
| polished | 72857 | 21035 |
| <i>euro/m</i> | 10,37 | - |
| <i>euro/pc</i> | - | 11,09 |

art. 300/ individually packed

Complete the article code with F=drilled, A-AD=adhesive, CV=screws (eg. 700/ drilled becomes 700/F)

 packaging in blister no partial packaging

For a single piece, see sales conditions on page 288

Prolevel 6/ is a line of transition profiles in aluminium, for floors of small thickness already laid. Available also in blister pack, self-adhesive and with screws, they are easily applicable in DIY field.

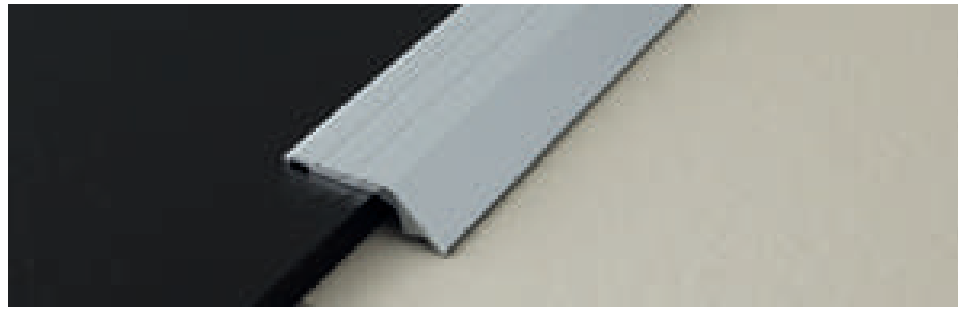

6/A silver anodised aluminium

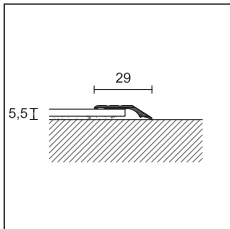

6/

PROLEVEL MEDIUM

| | | | | | | |
|------------------|--------|-------------|------------------|-------|-------|-------|
| pack | 30 pcs | | 10 pcs / blister | | | |
| length cm | 270 | | 93 | 166 | | |
| ART. | 6/ | | 46/ | | | |
| finishing | F | A | CV | AD | CV | AD |
| ALUMINIUM | | | | | | |
| silver anodised | | 72727 72757 | 20932 | 20952 | 20940 | 20960 |
| gold anodised | | 72737 72767 | 20933 | 20953 | - | - |
| bronze anodised | | - 72777 | - | - | - | - |
| euro/m | | 4,26 5,45 | - | - | - | - |
| euro/pc | | - - | 5,06 | 5,96 | 8,68 | 10,43 |

art. 6/ individually packed

Prolevel Medium 10/ and Prolevel Thin 54/ are two profiles for the connection of PVC floors. They can be installed on already-laid floors and they also acts as protection of the floor edge.



54/A gold anodised aluminium

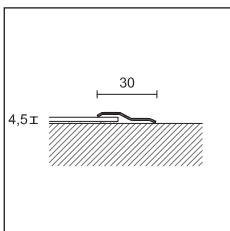

10/

PROLEVEL MEDIUM

| | | |
|------------------|--------|-------|
| pack | 20 pcs | |
| length cm | 270 | |
| ART. | 10/ | |
| finishing | A | |
| ALUMINIUM | | |
| silver anodised | | 72527 |
| euro/m | | 5,04 |

individually packed

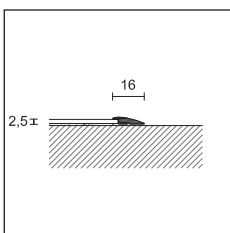

54/

PROLEVEL THIN

| | | | |
|-------------------------------|-----------------|----|-------------|
| length = 270 cm - pack 20 pcs | | | |
| ART. | finishing | SF | A |
| ALUMINIUM | | | |
| 54/ | silver anodised | | 72587 72617 |
| | gold anodised | | - 72627 |
| | euro/m | | 3,83 4,91 |

individually packed

Complete the item code with SF=undrilled, A-AD=adhesive, (eg. 54/ undrilled becomes 54/SF)

packaging in blister no partial packaging

For a single piece, see sales conditions on page 288





movement joints

A line designed to permit the expansion and contraction that materials undergo as a result of the seasonal temperature. A wide range of finishes to suit different stresses to which the coating is subjected.

movement joints

cerfix® projoint

Projoint DIL NE is an expansion joint in co-extruded PVC. Suitable for the laying with glue, it is available in three colors and four heights and it is suitable for large areas with pedestrian traffic. Set on the joints created on the screed, it allows to absorb stresses of compression and expansion.



NE/10 co-extruded PVC grey + grey RAL 7035

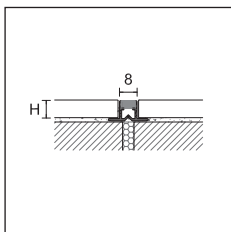

NE/

PROJOINT DIL

length = 270 cm

| ART. finishing | | H | | | |
|----------------------------|----------------------------------|-------------|-------------|-------------|-------------|
| | | 8 | 10 | 12,5 | 15 |
| CO-EXTRUDED PVC | | | | | |
| NE/ | grey+grey RAL 7035 | 99650 | 99660 | 99670 | 99680 |
| | stone grey+ stone grey RAL 7030 | 99653 | 99663 | 99673 | 99683 |
| | cream white+cream white RAL 9001 | 99652 | 99662 | - | - |
| pack 20 pcs euro/m | | 1,21 | 1,33 | 1,45 | 1,58 |
| pack 100 pcs euro/m | | 1,00 | 1,12 | 1,24 | 1,37 |

no partial packaging

Projoint DIL NJ/ is an expansion joint in co-extruded PVC with perforated side flanges. Suitable for floors laid with glue, it is able to absorb tensile and compression stresses, thanks to the elastic central part. Made of PVC non-toxic and anti shock, UV resistant and it can be used indoors and outdoors.



NJ/10 PVC co-extruded PVC light grey RAL 7035

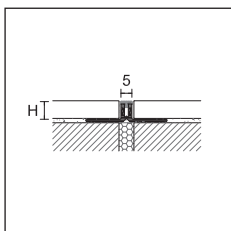

NJ/

PROJOINT DIL

length = 270 cm - pack 20 pcs

| ART. finishing | | H | | | | |
|------------------------|---------------------|-------------|-------------|-------------|-------------|-------------|
| | | 4,5 | 8 | 10 | 12,5 | 15 |
| CO-EXTRUDED PVC | | | | | | |
| NJ/ | light grey RAL 7035 | 99757 | 99750 | 99760 | 99770 | 99780 |
| | stone grey RAL 7030 | 99758 | 99752 | 99762 | 99772 | 99782 |
| euro/m | | 2,95 | 3,38 | 3,71 | 4,04 | 4,36 |

no partial packaging

Complete the article code with H measure (for example NE/ for H=8 becomes NE/8)

For a single piece, see sales conditions on page 288

Projoint DIL NL/ is an expansion joint in co-extruded PVC with perforated side flanges. Suitable for floors or marble laid with glue, it is able to absorb tensile and compression stresses thanks to the elastic central part. It is suitable for both pedestrian traffic and light driveway (car and transpallet). Made of PVC non-toxic and anti shock, UV resistant and it can be used indoors and outdoors.



NL/10 co-extruded PVC grey + grey RAL 7035

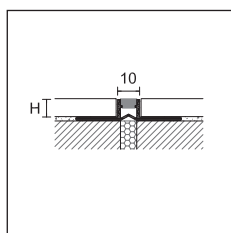

NL/

PROJOINT DIL

| length = 270 cm - pack 20 pcs | | H | | | | |
|-------------------------------|---------------------------------|-------------|-------------|-------------|-------------|-------------|
| ART. | finishing | 8 | 10 | 12,5 | 15 | 20 |
| CO-EXTRUDED PVC | | | | | | |
| NL/ | grey+grey RAL 7035 | 99700 | 99710 | 99720 | - | - |
| | stone grey+ stone grey RAL 7030 | 99704 | 99714 | 99724 | 99734 | 99744 |
| | black+black RAL 9005 | 99703 | 99713 | 99723 | - | - |
| euro/m | | 3,80 | 4,23 | 4,69 | 5,12 | 6,05 |

no partial packaging

Projoint DIL NF is an expansion joint in co-extruded PVC for the laying with mortar. Available in three colors and three heights, it is suitable to divide large areas with pedestrian traffic. It allows to absorb compressive and expansion stresses.

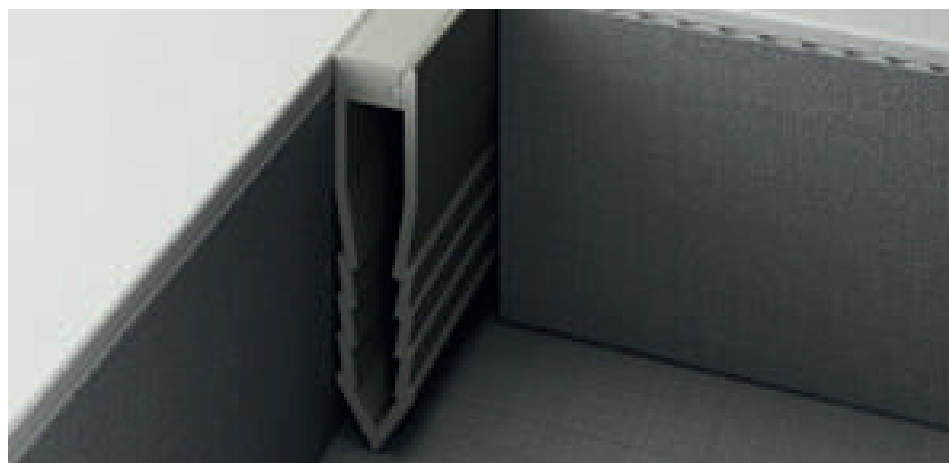

NF/45 co-extruded PVC grey + grey RAL 7035

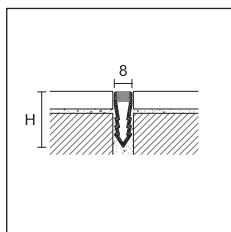

NF/

PROJOINT DIL

| length = 270 cm | | H | | |
|------------------------|----------------------------------|-------------|-------------|-------------|
| ART. | finishing | 25 | 35 | 45 |
| CO-EXTRUDED PVC | | | | |
| NF/ | grey+grey RAL 7035 | 99800 | 99810 | 99820 |
| | stone grey+ stone grey RAL 7030 | 99803 | 99813 | 99823 |
| | cream white+cream white RAL 9001 | 99802 | 99812 | - |
| pack 20 pcs | | | | |
| euro/m | | 1,73 | 1,97 | 2,39 |
| pack 40 pcs | | | | |
| euro/m | | - | - | 2,15 |
| pack 50 pcs | | | | |
| euro/m | | - | 1,73 | - |
| pack 80 pcs | | | | |
| euro/m | | 1,49 | - | - |

no partial packaging

Complete the article code with H measure (for example NL/ for H=10 becomes NL/10)

For a single piece, see sales conditions on page 288

movement joints

cerfix® projoint

Projoint DIL NAN is an expansion joint in aluminium, with an interchangeable insert in elastic vinyl resin, characterized by a visible section of 15 mm. The structure of the joint allows to protect the edge of the tile and is able to withstand high traffic, both pedestrian and vehicular.



NAN/10 natural aluminium + stone grey rubber

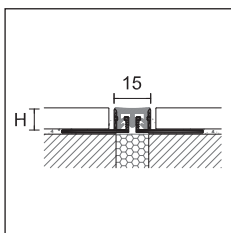

NAN/

PROJOINT DIL

length = 270 cm - pack 10 pcs

| | | H | | |
|------------------|--|--------------|--------------|--------------|
| ART. | finishing | 10 | 12,5 | 15 |
| ALUMINIUM | | | | |
| NAN/ | natural aluminium + grey RAL 7035 rubber | 99974 | 99975 | 99976 |
| | natural aluminium + stone grey RAL 7030 rubber | 99977 | 99978 | 99979 |
| <i>euro/m</i> | | 13,13 | 13,50 | 14,15 |

individually packed - NAN/ available with black rubber upon request, minimum order 100 pcs

SPARE INSERT FOR NAN/

length= 270 cm - pack 20 pcs

| ART. | finishing | | |
|---------------|---------------------|--|-------------|
| GM/ | grey RAL 7035 | | 99993 |
| | stone grey RAL 7030 | | 99989 |
| <i>euro/m</i> | | | 3,02 |

Projoint DIL NPAN/ is an expansion joint in aluminium, with an interchangeable insert in elastic vinyl resin, characterized by a visible section of 21 mm. The structure of the joint allows to protect the edge of the tile and is able to withstand high traffic, both pedestrian and vehicular.



NPAN/10 natural aluminium + stone grey rubber

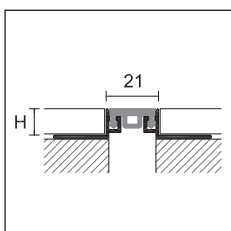

NPAN/

PROJOINT DIL

length = 270 cm - pack 10 pcs

| | | H | | |
|------------------|--|--------------|--------------|--------------|
| ART. | finishing | 10 | 12,5 | 15 |
| ALUMINIUM | | | | |
| NPAN/ | natural aluminium + stone grey RAL 7030 rubber | 99984 | 99985 | 99986 |
| | <i>euro/m</i> | 13,44 | 13,84 | 14,57 |

individually packed - NPAN/ available with black rubber upon request, minimum order 100 pcs

SPARE INSERT FOR NPAN/

length= 270 cm - pack 20 pcs

| ART. | finishing | | |
|---------------|---------------------|--|-------------|
| GMP/ | stone grey RAL 7030 | | 99988 |
| <i>euro/m</i> | | | 3,41 |

Complete the article code with H measure (for example NAN/ for H=10 becomes NAN/10)

For a single piece, see sales conditions on page 288

Projoint DIL NIN/ is an expansion joint in stainless steel, with an interchangeable insert in elastic vinyl resin, characterized by a reduced section of 15 mm. The structure of the joint allows to protect the edge of the tile and is able to withstand heavy traffic, both pedestrian and vehicular (forklifts, transpallets and cars).



NIN/10 stainless steel + stone grey rubber

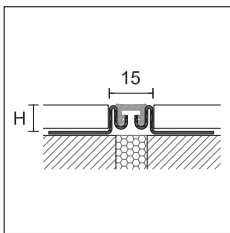

NIN/

PROJOINT DIL

length = 270 cm - pack 5 pcs

| | | H | | | |
|------------------------|--|--------------|--------------|--------------|--------------|
| ART. | finishing | 10 | 12,5 | 15 | 20 |
| STAINLESS STEEL | | | | | |
| NIN/ | stainless steel AISI 304 DIN 1.4301 + grey RAL 7035 rubber | 99915 | 99916 | 99917 | 99918 |
| | stainless steel AISI 304 DIN 1.4301 + stone grey RAL 7030 rubber | 99925 | 99926 | 99927 | 99928 |
| euro/m | | 26,44 | 27,28 | 28,09 | 29,77 |

individually packed - NIN/ available with black rubber upon request, minimum order 100 pcs

SPARE INSERT FOR NIN/

length= 270 cm - pack 20 pcs

| ART. | finishing | | |
|---------------|---------------------|--|-------------|
| GM/10 | grey RAL 7035 | | 99998 |
| | stone grey RAL 7030 | | 99999 |
| euro/m | | | 3,02 |

Projoint DIL NIL/ is a perimeter expansion joint in stainless steel, with an interchangeable insert in elastic vinyl resin, characterized by a visible section of 14 mm. The structure of the joint allows to connect the floor to the wall and is able to withstand heavy traffic, both pedestrian and vehicular (forklifts, transpallets and cars).



NIL/10 stainless steel + stone grey rubber

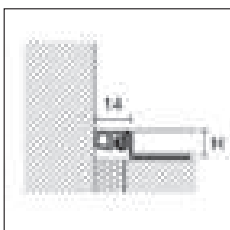

NIL/

NEW PROJOINT DIL

length = 270 cm - pack 5 pcs

| | | H | | | |
|------------------------|--|--------------|--------------|--------------|--------------|
| ART. | finishing | 10 | 12,5 | 15 | 20 |
| STAINLESS STEEL | | | | | |
| NIL/ | stainless steel AISI 304 DIN 1.4301 + stone grey RAL 7030 rubber | 99896 | 99897 | 99898 | 99899 |
| | euro/m | 18,18 | 18,93 | 19,82 | 21,47 |

individually packed - NIL/ available with black rubber upon request, minimum order 100 pcs

SPARE INSERT FOR NIL/

length= 270 cm - pack 20 pcs

| ART. | finishing | | |
|---------------|---------------------|--|-------------|
| GM12/L | stone grey RAL 7030 | | 99987 |
| euro/m | | | 3,02 |

Complete the article code with H measure (for example NIN/ for H=10 becomes NIN/10)

For a single piece, see sales conditions on page 288

Projoint NTA/, NTI/ and NTO/ are expansion joints for the laying with glue with inner section in vulcanized EPDM. The metal structure easily stands up to the recurring pedestrian and vehicular traffic (forklift trucks, transpallets and cars).



NTA/10 natural aluminium + EPDM grey polishable RAL 7046

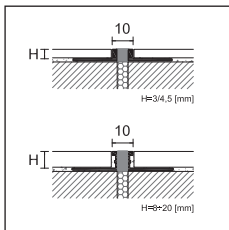

NTA/
NTO/

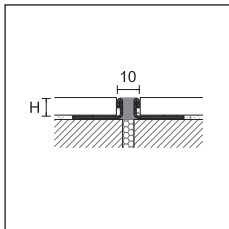

NTI/

Projoint STA/ and STI/ are expansion joints for the division of floors laid with mortar, with inner section in vulcanized EPDM. The metal structure easily withstands the recurring pedestrian and vehicular traffic (forklift trucks, transpallets and cars), making them particularly suitable for shopping malls and frequent passage of loads. We suggest the use of the stainless steel hooks ST/7 for the installation.

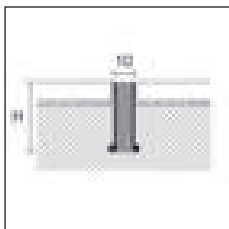

STA/
STI/

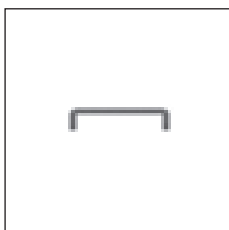

ST/7

PROJOINT DIL

length = 270 cm - pack 10 pcs

| ART. | finishing | 3 | 4,5 | 8 | 10 | 12,5 | 15 | 20 |
|--|---|--------------|--------------|--------------|--------------|--------------|--------------|--------------|
| ALUMINIUM | | | | | | | | |
| NTA/ | natural aluminium + EPDM grey polishable RAL 7046 | 99421 | 99425 | 99441 | 99445 | 99449 | 99453 | 99457 |
| | natural aluminium + EPDM black polishable RAL 9005 | 99422 | 99426 | 99442 | 99444 | 99450 | 99454 | 99458 |
| | euro/m | 21,35 | 22,14 | 22,91 | 23,72 | 25,20 | 26,81 | 30,51 |
| | natural aluminium + EPDM bahama polishable RAL 10070 | 99427 | 99428 | - | - | - | - | - |
| natural aluminium + EPDM brown polishable RAL 10071 | 99429 | 99430 | - | - | - | - | - | |
| euro/m | 21,35 | 22,14 | - | - | - | - | - | |
| STAINLESS STEEL | | | | | | | | |
| NTI/ | stainless steel AISI 304 DIN 1.4301 + EPDM grey RAL 7046 | 99471 | 99475 | 99481 | 99485 | 99489 | 99493 | 99497 |
| | stainless steel AISI 304 DIN 1.4301 + EPDM black RAL 9005 | 99472 | 99474 | 99482 | 99486 | 99490 | - | - |
| | euro/m | 32,84 | 33,27 | 34,88 | 36,76 | 39,33 | 42,06 | 47,76 |
| | stainless steel AISI 304 DIN 1.4301 + EPDM bahama RAL 10070 | 99431 | 99432 | - | - | - | - | - |
| stainless steel AISI 304 DIN 1.4301 + EPDM brown RAL 10071 | 99433 | 99434 | - | - | - | - | - | |
| euro/m | 32,84 | 33,27 | - | - | - | - | - | |
| STAINLESS STEEL | | | | | | | | |
| NTO/ | brass natural + EPDM grey polishable RAL 7046 | - | - | 99401 | 99405 | 99409 | 99413 | 99417 |
| euro/m | - | - | 39,19 | 41,69 | 44,77 | 48,12 | 55,02 | |

art. NTO/15 and NTO/20 pack 5 pcs



STI/40 stainless steel AISI 304 DIN 1.4301 + EPDM grey polishable RAL 7046

PROJOINT DIL

length = 250 cm - pack 10 pcs

| ART. | finishing | 30 | 40 | 50 |
|------------------------|---|--------------|--------------|--------------|
| ALUMINIUM | | | | |
| STA/ | natural aluminium + EPDM grey polishable RAL 7046 | 99581 | 99585 | 99589 |
| | euro/m | 42,35 | 52,40 | 62,43 |
| STAINLESS STEEL | | | | |
| STI/ | stainless steel AISI 304 DIN 1.4301 + EPDM grey polishable RAL 7046 | 99621 | 99625 | 99629 |
| | euro/m | 50,86 | 58,37 | 69,65 |

Upon request, we can make different measures and colours for articles STA/, STI/ and STO. Please contact our sales department

ACCESSORIES

pack 100 pcs

| ART. | finishing | |
|----------------------------|---------------------------------------|---------------------|
| STAINLESS STEEL | | |
| ST/7 | steel hook for STA/ and STI/ profiles | 99640 |
| euro/pc (euro/pack) | | 0,64 (64,00) |

no partial packaging

Projoint NZA is an expansion joint in aluminium consisting of two interlocking and sliding profiles. Suitable for ceramic floors subjected to intense traffic, it ensures a high resistance to loads and high traffic both pedestrian and vehicular (forklifts, transpallet and cars).



NZA/10 natural aluminium

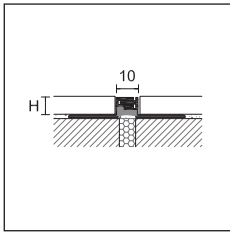

NZA/

PROJOINT DIL

length = 270 cm - pack 20 pcs

| | | H | | | | |
|------------------|-------------------|-------|-------|-------|-------|-------|
| ART. | finishing | 3 | 5 | 8 | 10 | 12,5 |
| ALUMINIUM | | | | | | |
| NZA/ | natural aluminium | - | - | 99910 | 99912 | 99914 |
| | euro/m | - | - | 13,60 | 13,99 | 14,40 |
| NZA/ | silver anodised | 99300 | 99320 | - | - | - |
| | euro/m | 15,33 | 15,72 | - | - | - |

individually packed

Projoint NZS is an expansion joint in aluminium with high absorption. Thanks to the 2 interlocking parts, the joint can absorb movements of +/- 5 mm with articulated flins that permit tridimensional movements. The structure of the joint protects the edge of the tile, and it bears the pedestrian and vehicular passage. NZS is also available as a joint cover (when tiles are already laid), NZS/A, or side joint for industrial buildings, NZS/L.



NZS/10 silver anodised aluminium

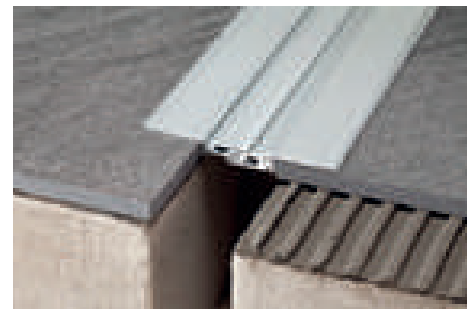

NZS/A/40 silver anodised aluminium

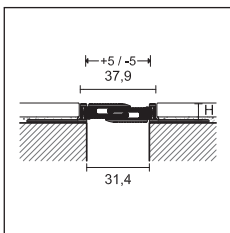

NZS/

PROJOINT DIL

length = 270 cm - pack 5 pcs

| | | H | | | |
|------------------|-----------------|-------|-------|-------|-------|
| ART. | finishing | 10 | 12,5 | 15 | 20 |
| ALUMINIUM | | | | | |
| NZS/ | silver anodised | 99880 | 99881 | 99882 | 99883 |
| | euro/m | 35,90 | 36,34 | 36,75 | 37,61 |

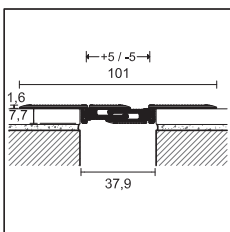

NZS/A/40

PROJOINT DIL

length = 270 cm - pack 5 pcs

| | | H |
|------------------|-----------------|-------|
| ART. | finishing | 8 |
| ALUMINIUM | | |
| NZS/A/40 | silver anodised | 99885 |
| | euro/m | 35,90 |

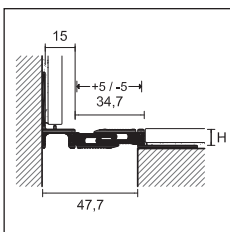

NZS/L/

PROJOINT DIL

length = 270 cm - pack 5 pcs

| | | H | | | |
|------------------|-----------------|-------|-------|-------|-------|
| ART. | finishing | 10 | 12,5 | 15 | 20 |
| ALUMINIUM | | | | | |
| NZS/L/ | silver anodised | 99890 | 99891 | 99892 | 99893 |
| | euro/m | 35,90 | 36,34 | 36,75 | 37,61 |

Complete the article code with H measure (for example NZA/ for H=8 becomes NZA/8)

For a single piece, see sales conditions on page 288

cerfix® projoint

Projoint DIL PBE is a structural joint composed of two L-shaped profiles in natural aluminium and an expanding part in interchangeable plasticized PVC, available in black or grey. The two L-shaped profiles have drilled bases to allow the mechanical fixing with screws to the underlying structure.



PBE/30 natural aluminium + striated black rubber

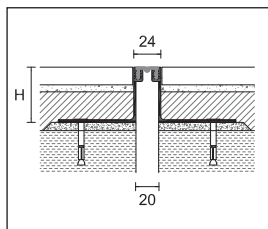

PBE/20 smooth rubber

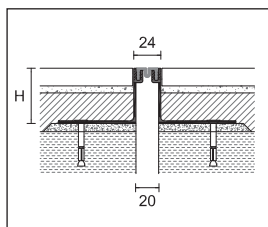

PBE/20 striated rubber

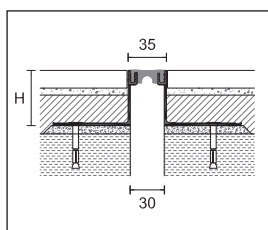

PBE/30 smooth rubber

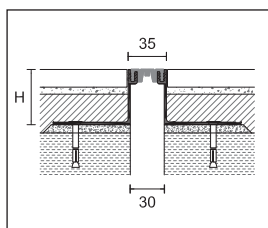

PBE/30 striated rubber

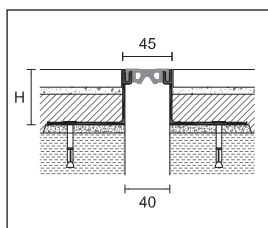

PBE/40 smooth rubber

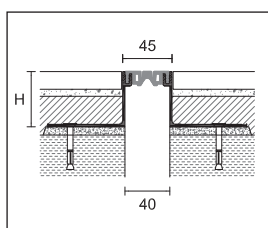

PBE/40 striated rubber

PROJOINT DIL

length = 300 cm - pack 5 pcs

| ART. | finishing | 14 | 24 | 42 | 50 | 82 |
|------------------|---|--------------|--------------|--------------|--------------|--------------|
| ALUMINIUM | | | | | | |
| | natural aluminium + smooth grey rubber | 99321 | 99322 | 99323 | 99324 | 99325 |
| | natural aluminium + smooth black rubber | 99326 | 99327 | 99328 | 99329 | 99330 |
| PBE/20/ | euro/m | 35,39 | 36,72 | 44,70 | 55,37 | 66,31 |
| | natural aluminium + striated grey rubber | 99331 | 99332 | 99333 | 99334 | 99335 |
| | natural aluminium + striated black rubber | 99336 | 99337 | 99338 | 99339 | 99340 |
| | euro/m | 35,39 | 36,72 | 44,70 | 55,37 | 66,31 |

no partial packaging - profiles are provided with accessories for mechanical fixing



smooth rubber



striated rubber

PROJOINT DIL

length = 300 cm - pack 5 pcs

| ART. | finishing | 14 | 24 | 42 | 50 | 82 |
|------------------|---|--------------|--------------|--------------|--------------|--------------|
| ALUMINIUM | | | | | | |
| | natural aluminium + smooth grey rubber | 99341 | 99342 | 99343 | 99344 | 99345 |
| | natural aluminium + smooth black rubber | 99346 | 99347 | 99348 | 99349 | 99350 |
| PBE/30/ | euro/m | 38,57 | 40,43 | 48,29 | 58,31 | 69,37 |
| | natural aluminium + striated grey rubber | 99351 | 99352 | 99353 | 99354 | 99355 |
| | natural aluminium + striated black rubber | 99356 | 99357 | 99358 | 99359 | 99360 |
| | euro/m | 38,57 | 40,43 | 48,29 | 58,31 | 69,37 |

no partial packaging - profiles are provided with accessories for mechanical fixing



smooth rubber



striated rubber

PROJOINT DIL

length = 300 cm - pack 5 pcs

| ART. | finishing | 14 | 24 | 42 | 50 | 82 |
|------------------|---|--------------|--------------|--------------|--------------|--------------|
| ALUMINIUM | | | | | | |
| | natural aluminium + smooth grey rubber | 99361 | 99362 | 99363 | 99364 | 99365 |
| | natural aluminium + smooth black rubber | 99366 | 99367 | 99368 | 99369 | 99370 |
| PBE/40/ | euro/m | 41,36 | 42,69 | 50,43 | 56,70 | 72,57 |
| | natural aluminium + striated grey rubber | 99371 | 99372 | 99373 | 99374 | 99375 |
| | natural aluminium + striated black rubber | 99376 | 99377 | 99378 | 99379 | 99380 |
| | euro/m | 41,36 | 42,69 | 50,43 | 56,70 | 72,57 |

no partial packaging - profiles are provided with accessories for mechanical fixing



smooth rubber



striated rubber

We suggest the use of the black insert.

Delivery times to be agreed.

Projoint DIL PBH and PAS are two structural joints composed of two L-shaped profiles in natural aluminium and an expanding part in interchangeable EPDM, available in black or grey. Projoint DIL PHDE is a structural joint composed of two interlocking and sliding profiles in natural aluminium. All profiles have drilled bases to allow the mechanical fixing with screws to the underlying structure and are designed to withstand structural movements of big buildings.



PBH/65/ natural aluminium + black EPDM insert

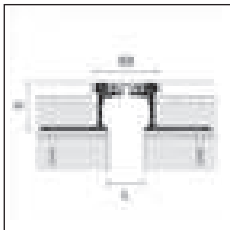

PBH/65

PROJOINT DIL

length = 300 cm - pack 2 pcs

| | | H | | | |
|------------------|---------------------------------------|--------------|--------------|---------------|---------------|
| ART. | finishing | 18 | 35 | 50 | 80 |
| ALUMINIUM | | L=50 | L=40 | L=40 | L=40 |
| PBH/65/ | natural aluminium + grey EPDM insert | 99500 | 99501 | 99502 | 99503 |
| | natural aluminium + black EPDM insert | 99504 | 99505 | 99506 | 99507 |
| euro/m | | 86,72 | 97,52 | 118,46 | 154,75 |

no partial packaging - profiles are provided with accessories for mechanical fixing

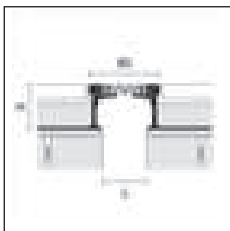

PBH/75

PROJOINT DIL

length = 300 cm - pack 2 pcs

| | | H | | | |
|------------------|---------------------------------------|--------------|---------------|---------------|---------------|
| ART. | finishing | 18 | 35 | 50 | 80 |
| ALUMINIUM | | L=60 | L=50 | L=50 | L=50 |
| PBH/75/ | natural aluminium + grey EPDM insert | 99508 | 99509 | 99510 | 99511 |
| | natural aluminium + black EPDM insert | 99512 | 99513 | 99514 | 99515 |
| euro/m | | 96,05 | 109,39 | 127,01 | 170,75 |

no partial packaging - profiles are provided with accessories for mechanical fixing

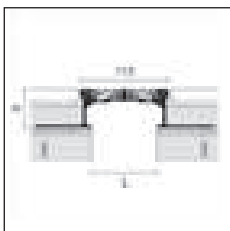

PAS/105

PROJOINT DIL

length = 300 cm - pack 2 pcs

| | | H | | | |
|------------------|---------------------------------------|---------------|---------------|---------------|---------------|
| ART. | finishing | 18 | 35 | 50 | 80 |
| ALUMINIUM | | L=95 | L=85 | L=85 | L=85 |
| PAS/105/ | natural aluminium + grey EPDM insert | 99516 | 99517 | 99518 | 99519 |
| | natural aluminium + black EPDM insert | 99520 | 99521 | 99522 | 99523 |
| euro/m | | 150,75 | 164,09 | 172,50 | 216,11 |

no partial packaging - profiles are provided with accessories for mechanical fixing

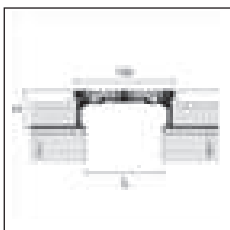

PAS/125

PROJOINT DIL

length = 300 cm - pack 2 pcs

| | | H | | | |
|------------------|---------------------------------------|---------------|---------------|---------------|---------------|
| ART. | finishing | 18 | 35 | 50 | 80 |
| ALUMINIUM | | L=111 | L=100 | L=100 | L=100 |
| PAS/125/ | natural aluminium + grey EPDM insert | 99524 | 99525 | 99526 | 99527 |
| | natural aluminium + black EPDM insert | 99528 | 99529 | 99530 | 99531 |
| euro/m | | 166,48 | 181,03 | 210,78 | 240,92 |

no partial packaging - profiles are provided with accessories for mechanical fixing

We suggest the use of the black insert.

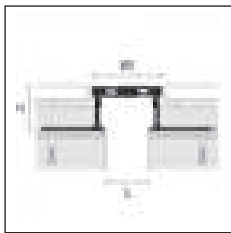

PHDE/80

PROJOINT DIL

| length = 300 cm - pack 2 pcs | | H | | | |
|------------------------------|-------------------|--------|--------|--------|--------|
| ART. | finishing | 18 | 35 | 50 | 80 |
| ALUMINIUM | | L=60 | L=50 | L=50 | L=50 |
| PHDE/80/ | natural aluminium | 99590 | 99591 | 99592 | 99593 |
| | euro/m | 118,46 | 145,14 | 181,43 | 222,24 |

no partial packaging - profiles are provided with accessories for mechanical fixing

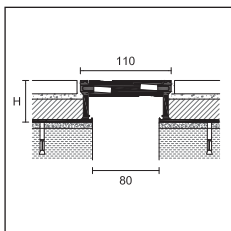

PHDE/110

PROJOINT DIL

| length = 300 cm - pack 2 pcs | | H | |
|------------------------------|-------------------|--------|--------|
| ART. | finishing | 50 | 80 |
| ALUMINIUM | | | |
| PHDE/110/ | natural aluminium | 99594 | 99595 |
| | euro/m | 206,92 | 238,67 |

no partial packaging - profiles are provided with accessories for mechanical fixing

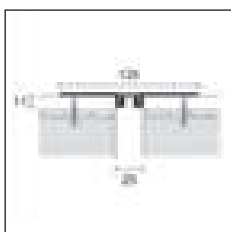

PFFE/20

PROJOINT DIL

| length = 300 cm - pack 5 pcs | | H | |
|------------------------------|---|-------|--|
| ART. | finishing | | |
| ALUMINIUM | | | |
| | natural aluminium + smooth grey rubber | 99596 | |
| | natural aluminium + smooth black rubber | 99597 | |
| PFFE/20/ | euro/m | 32,29 | |
| | natural aluminium + striated grey rubber | 99598 | |
| | natural aluminium + striated black rubber | 99599 | |
| | euro/m | 32,29 | |

no partial packaging - profiles are provided with accessories for mechanical fixing



smooth rubber striated rubber

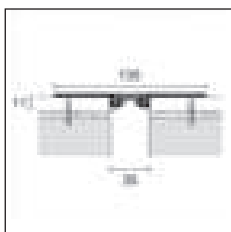

PFFE/30

PROJOINT DIL

| length = 300 cm - pack 5 pcs | | H | |
|------------------------------|---|-------|--|
| ART. | finishing | | |
| ALUMINIUM | | | |
| | natural aluminium + smooth grey rubber | 99600 | |
| | natural aluminium + smooth black rubber | 99601 | |
| PFFE/30/ | euro/m | 39,10 | |
| | natural aluminium + striated grey rubber | 99602 | |
| | natural aluminium + striated black rubber | 99603 | |
| | euro/m | 39,10 | |

no partial packaging - profiles are provided with accessories for mechanical fixing



smooth rubber striated rubber

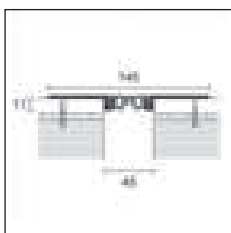

PFFE/40

PROJOINT DIL

| length = 300 cm - pack 5 pcs | | H | |
|------------------------------|---|-------|--|
| ART. | finishing | | |
| ALUMINIUM | | | |
| | natural aluminium + smooth grey rubber | 99604 | |
| | natural aluminium + smooth black rubber | 99605 | |
| PFFE/40/ | euro/m | 43,63 | |
| | natural aluminium + striated grey rubber | 99606 | |
| | natural aluminium + striated black rubber | 99607 | |
| | euro/m | 43,63 | |

no partial packaging - profiles are provided with accessories for mechanical fixing



smooth rubber striated rubber

Procover Flex is a line of structural aluminium joint covers designed to withstand traction and compression transverse movements of large buildings.

They withstand both pedestrian and vehicular traffic with rubber wheels (cars).

Procover Fix is a line of flat joint cover profiles in aluminium for coplanar floors (GJA/) and perimeter joint cover profiles for the connection of floors and walls (GWA/), suitable to cover structural movements of expansion or compression of two different structures.

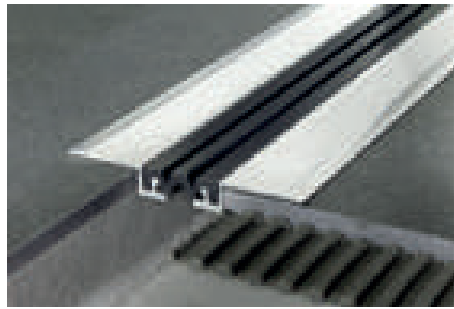

GJF/40 natural aluminium + EPDM black RAL 9005

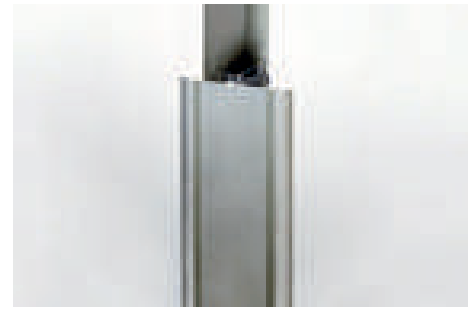

GJA/70 silver anodised aluminium

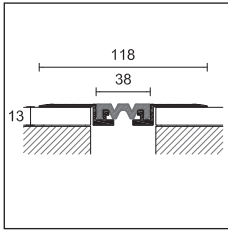

GJF/40

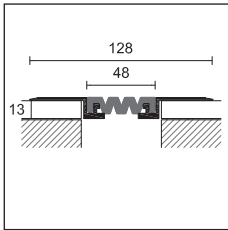

GJF/50

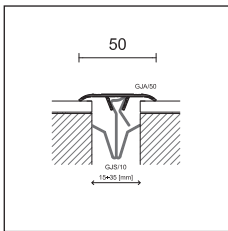

GJA/50

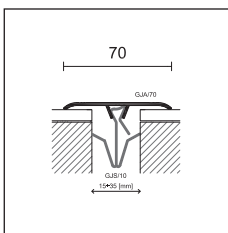

GJA/70

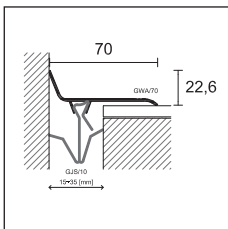

GWA/70

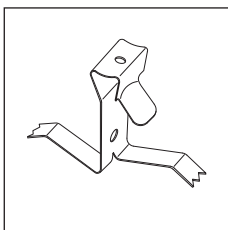

GJS/10

PROCOVER FLEX

length = 400 cm - pack 5 pcs

L

| ART. | finishing | 40 | 50 |
|------------------|--|-------|-------|
| ALUMINIUM | | | |
| GJF/ | natural aluminium + EPDM black insert RAL 9005 | 74490 | 74492 |
| | euro/m | 34,84 | 37,80 |

SPARE INSERT

length = 400 cm

L

| ART. | finishing | 40 | 50 |
|------------------|---------------------|-------|-------|
| ALUMINIUM | | | |
| GM/ | EPDM black RAL 9005 | 74491 | 74493 |
| | euro/m | 11,20 | 14,70 |

PROCOVER FIX

length = 300 cm - pack 10 pcs

L

| ART. | finishing | 50 | 70 |
|------------------|-----------------|-------|-------|
| ALUMINIUM | | | |
| GJA/ | silver anodised | 74550 | 74610 |
| | euro/m | 16,21 | 28,08 |
| GWA/ | silver anodised | - | 74552 |
| | euro/m | - | 25,17 |

SPRING CLIP

from 15 to 35 mm - pack 50 pcs

STAINLESS STEEL

| | | |
|--------|--------------------------|-------|
| GJS/10 | harmonic stainless steel | 74730 |
| | euro/pc | 2,31 |

Complete the article code with L measure (for example GJF/ for L=40 becomes GJF/40)

For a single piece, see sales conditions on page 288

cerfix® procover

Procover G in anodized aluminium are joint covering profiles, suitable for creating continuity on structures with continuous bays. These joint coverings are supplied with adhesive or are fixed with screws and dowels.

In this case it is perforated laterally, and fixed only to one structure allowing the free sliding over the other.



G/80/A silver anodised aluminium

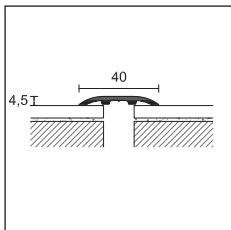

G/40/

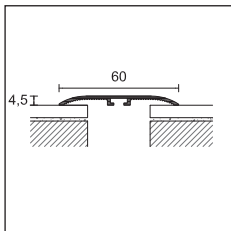

G/60/

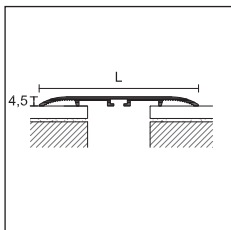

G/80/

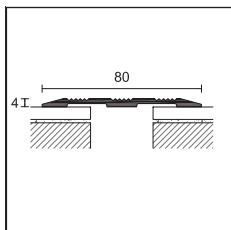



GR/80/SF

Complete the article code with A-AD=adhesive, SF=undrilled (for example G/40/ adhesive becomes G/40/A)

 packaging in blister no partial packaging

For a single piece, see sales conditions on page 288

PROCOVER

| pack | 20 pcs | 20 pcs |  6 pcs / blister | 20 pcs | | |
|------------------|---|--------|---|---------|-------|-------|
| length cm | 300 | 300 | 100 | 300 | | |
| ART. | G/40/ | G/60/ | G/460/ | G/80/ | | |
| finishing | A | SF | A | AD SF A | | |
| ALUMINIUM | | | | | | |
| silver anodised |  74528 | 74558 | 74588 | 21982 | 74618 | 74648 |
| euro/m | 8,88 | 9,67 | 11,58 | - | 12,86 | 14,81 |
| euro/pc | - | - | - | 13,14 | - | - |

art. G/40, G/60 and G/80 individually packed

PROCOVER

| | |
|-------------------------------|---|
| length = 270 cm - pack 10 pcs | L |
| width | 80 |
| ART. | GR/80/ |
| finishing | SF |
| ALUMINIUM | |
| silver anodised |  71855 |
| euro/m | 16,20 |

individually packed



GR/80/SF silver anodised aluminium

Procover G in stainless steel and polished brass are joint covering profiles, suitable for creating continuity on structures with continuous bays. These joint coverings are supplied with adhesive or are fixed with screws and dowels. In this case it is perforated laterally, and fixed only to one structure allowing the free sliding over the other. In these versions they are suitable even to vehicular traffic.

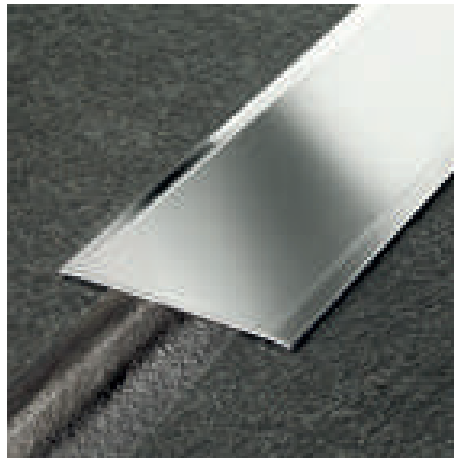

760/SF polished stainless steel AISI430-DIN 1.4016



0100/A polished brass

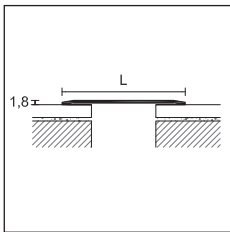

PROCOVER

| | | | | | | | |
|-----------|--------|-----------------|--------|-----------------|-------|-----------------|-------|
| pack | 10 pcs | 6 pcs / blister | 10 pcs | 6 pcs / blister | 5 pcs | 3 pcs / blister | 5 pcs |
| length cm | 300 | 100 | 300 | 100 | 300 | 100 | 300 |
| width mm | 50 | 50 | 60 | 60 | 80 | 80 | 100 |
| thickness | 12/10 | | | | | | |
| ART. | 750/ | 4750/ | 760/ | 4760/ | 780/ | 4780/ | 7100/ |
| finishing | SF A | AD | SF A | AD | SF A | AD | SF A |

STAINLESS STEEL

| | | | | | | | | | | | |
|--|-------|-------|-------|-------|-------|-------|-------|-------|-------|-------|-------|
| polished stainless steel AISI 430 - DIN 1.4016 | 74818 | 74828 | 22090 | 74838 | 74848 | 40531 | 74858 | 74868 | 40553 | 74878 | 74888 |
| euro/m | 13,24 | 15,52 | - | 16,20 | 18,48 | - | 21,05 | 23,31 | - | 24,75 | 27,02 |
| euro/pc | - | - | 17,26 | - | - | 20,31 | - | - | 25,21 | - | - |

art. 750/, 760/, 780/, 7100/ individually packed

PROCOVER

| | | | | | | | |
|-----------|--------|-----------------|-------|-----------------|-------|-----------------|--------|
| pack | 10 pcs | 6 pcs / blister | 5 pcs | 6 pcs / blister | 5 pcs | 3 pcs / blister | 5 pcs. |
| length cm | 300 | 100 | 300 | 100 | 300 | 100 | 300 |
| width mm | 50 | 50 | 60 | 60 | 80 | 80 | 100 |
| thickness | 13/10 | | | | | | |
| ART. | 050/ | 4050/ | 060/ | 4060/ | 080/ | 4080/ | 0100/ |
| finishing | SF A | AD | SF A | AD | SF A | AD | SF A |

STAINLESS STEEL

| | | | | | | | | | | | |
|----------|-------|-------|-------|-------|-------|-------|---|-------|-------|-------|-------|
| polished | 74738 | 74748 | 22050 | 74758 | 74768 | 40504 | - | 74788 | 40512 | 74798 | 74808 |
| euro/m | 25,02 | 27,89 | - | 30,41 | 33,32 | - | - | 42,23 | - | 47,17 | 50,10 |
| euro/pc | - | - | 30,03 | - | - | 35,46 | - | - | 44,37 | - | - |

art. 050/, 060/, 080/, 0100/ individually packed

Complete the article code with A-AD=adhesive, SF=undrilled (eg. 050/ adhesive becomes 050/A)

 packaging in blister no partial packaging

For a single piece, see sales conditions on page 288





waterproofing, drainage, uncoupling

A line of waterproofing, uncoupling and draining membranes for the laying of ceramic floors and coverings of bathrooms, balconies, terraces and problematic supports.

wpstop

WPstop is a waterproof membrane in polyethylene with a textile in polypropylene in both sides in order to facilitate the grip of the adhesive, thus ensuring a high adhesion to the support. It is particularly suitable for the waterproofing of floors and tiled walls of bathrooms. PAIG/ are special pre-formed pieces for waterproofing the internal corners of floor-level showers using Glass Profile GPS1 and GPS3.



WPstop system



rolls and stripes

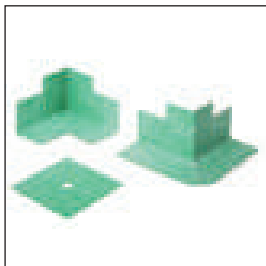

corners and colar

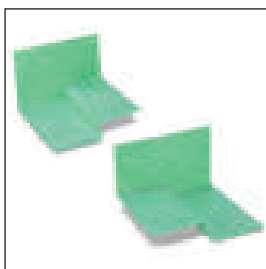

PAIG/DX/
PAIG/SX/

WPSTOP

| ART. | measures | |
|-------------|--|--------------|
| PR30 | roll 1 m height 30 mt length - pack 1 roll | 19900 |
| | <i>euro/m</i> | 10,37 |
| PR5 | roll 1 m height 5 mt length - pack 6 rolls | 19902 |
| | <i>euro/m</i> | 12,16 |
| PB30 | stripe 14 cm height 30 mt length - pack 1 roll | 19910 |
| | <i>euro/m</i> | 3,18 |
| PB5 | stripe 14 cm height 5 mt length - pack 6 rolls | 19912 |
| | <i>euro/m</i> | 4,12 |
| PAE | outside corners - pack 10 pcs | 19920 |
| | <i>euro/pc</i> | 7,65 |
| PAI | inside corners - pack 10 pcs | 19922 |
| | <i>euro/pc</i> | 7,65 |
| PF12 | colar cm 12x12 - pack 10 pcs | 19930 |
| | <i>euro/pc</i> | 5,95 |

no partial packaging

NEW WPSTOP - CORNERS FOR GLASS PROFILE GPS1 AND GPS3

| ART. | measures | DX | SX |
|----------------|------------------------------|-----------------------|-----------------------|
| PAIG/15 | inside corners - pack 10 pcs | 19931 | 19932 |
| | <i>euro/pc (euro/pack)</i> | 14,31 (143,10) | 14,31 (143,10) |
| PAIG/20 | inside corners - pack 10 pcs | 19933 | 19934 |
| | <i>euro/pc (euro/pack)</i> | 14,31 (143,10) | 14,31 (143,10) |
| PAIG/28 | inside corners - pack 10 pcs | 19935 | 19936 |
| | <i>euro/pc (euro/pack)</i> | 14,31 (143,10) | 14,31 (143,10) |
| PAIG/38 | inside corners - pack 10 pcs | 19937 | 19938 |
| | <i>euro/pc (euro/pack)</i> | 14,31 (143,10) | 14,31 (143,10) |

no partial packaging

INSTRUCTIONS

Store in a cool and dry place, avoiding direct exposure to sunlight and heat sources.

Please refer to the technical data sheet before the installation. For special installations, please contact our technical department.

For a single piece, see sales conditions on page 288

WPstop 3 is an uncoupling, waterproofing and anti-fracture membrane for indoor and outdoor use, particularly recommended before the laying of floors of bathrooms, balconies, terraces and problematic supports. WPstop Drain 10 is a draining membrane in high-density polyethylene (HDPE) with truncated cones structure and a filtering permeable fabric on the upper side. WPstop Drain 10 complies with the regulation UNI 11493-1 which requires a protective draining layer in case of waterproofing under the screed.

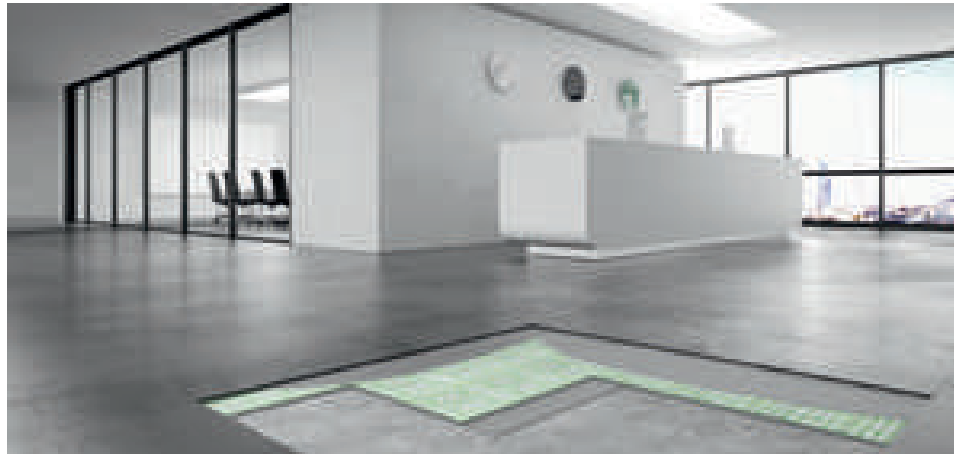

WPstop 3



PWP30

WPSTOP 3

ART. measures

| | | |
|--------------|--|--------------|
| PWP30 | roll 1 m height 30 mt length - pack 8 rolls | 19940 |
| | <i>euro/m</i> | 15,71 |
| PBE30 | elastic stripe of 12 cm height and 30 m length - pack 1 roll | 19945 |
| | <i>euro/m</i> | 4,31 |
| PBE5 | elastic stripe of 12 cm height and 5 m length - pack 6 rolls | 19946 |
| | <i>euro/m</i> | 5,22 |

no partial packaging for PBE30 and PBE5

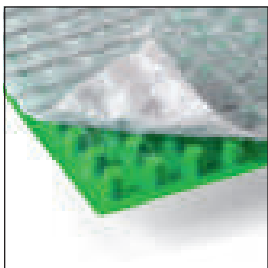

PWD12

WPSTOP DRAIN 10

ART. measures

| | | |
|--------------|--|--------------|
| PWD12 | roll of 0,96 m height and 12,5 m length - pack 6 rolls | 19950 |
| | <i>euro/m</i> | 13,60 |

INSTRUCTIONS

Store in a cool and dry place, avoiding direct exposure to sunlight and heat sources. Please refer to the technical data sheet before the installation. For special installations, please contact our technical department.

MS POLYMER-BASED ADHESIVE

pack 24 pcs - quantity 290 ml

ART. measures

| | |
|----------------|--------------|
| PP/96 | 78301 |
| <i>euro/pc</i> | 18,81 |



WPstop3 - uncoupling

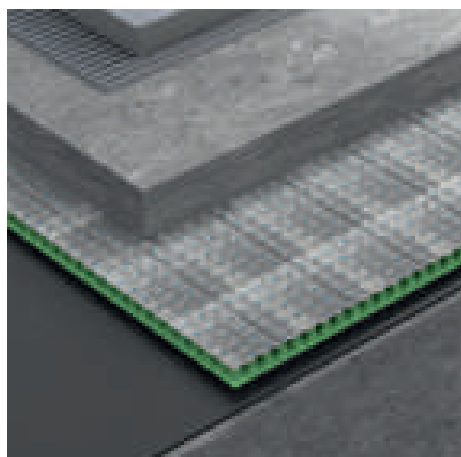

WPstop Drain 10

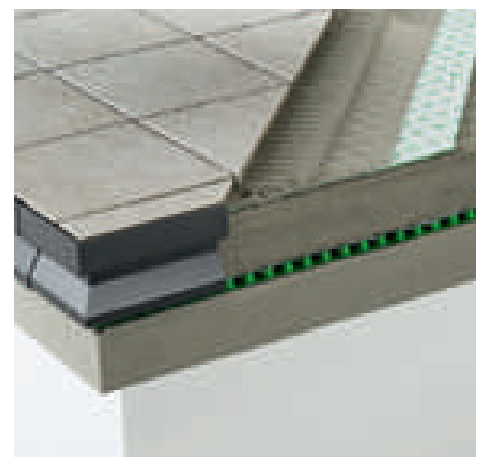

WPstop3 + WPstop3 drain 10





profiles for balconies and terraces

A functional and stylish line for the protection of terraces, balconies and pavements. The effectiveness of the protection decorates and completes every architectural detail.

Protec CPCV and CPCI are a series of edge profiles for the protection and the finishing of the outside edges of terraces and balconies. Available in colour-coated aluminium and stainless steel, they have been designed with a protruding section and can be used with tiles thicknesses up to 21 mm. In addition to protecting and finishing the outside edges, they guarantee the outflow of water from the floor, avoiding the contact with the outside border.

Protec CPCV is also available in the bendable version CPCVF, provided with a special cutout that allows to bend the profile with a radius up to 1 meter.



CPCV/55/10 ancient grey colour-coated aluminium

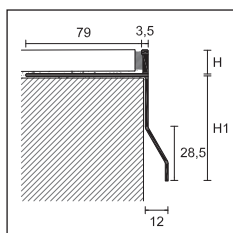

CPCV/

PROTEC

length = 270 cm - pack 10 pcs

| ART. | H | | | | | | | | |
|--------------------------------|--------------|--------------|--------------|--------------|--------------|--------------|--------------|--------------|--------------|
| | 10 | 12,5 | 21 | 10 | 12,5 | 21 | 10 | 12,5 | 21 |
| finishing | | | | | | | | | |
| COLOUR-COATED ALUMINIUM | | | | | | | | | |
| white RAL 9003 | 87677 | 87678 | - | 87687 | 87688 | - | 87697 | 87698 | - |
| ash grey RAL 7038 | 87681 | 87682 | 87660 | 87691 | 87692 | 87661 | 87701 | 87702 | 87662 |
| ash grey RAL 7038 embossed | 87713 | 87714 | - | 87715 | 87716 | - | 87717 | 87718 | - |
| dark brown RAL 8019 | 87683 | 87684 | - | 87693 | 87694 | - | 87703 | 87704 | - |
| rust | 87616 | 87617 | - | 87618 | 87619 | - | - | - | - |
| metal grey RAL 9006 | 87720 | 87721 | - | 87723 | 87724 | - | 87726 | 87727 | - |
| aluminium grey RAL 9007 | 87750 | 87751 | - | 87753 | 87754 | - | 87756 | 87757 | - |
| ancient grey | 87707 | 87708 | - | 87709 | 87710 | - | 87711 | 87712 | - |
| euro/m | 19,57 | 19,57 | 23,42 | 22,09 | 22,09 | 25,95 | 25,21 | 25,21 | 29,07 |

For colours on request please contact our sales department

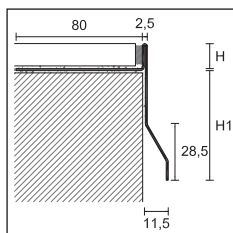

CPCI/

PROTEC

length = 270 cm - pack 10 pcs

| ART. | H | | | | | |
|--|--------------|--------------|----|--------------|--------------|------|
| | 10 | 12,5 | 10 | 12,5 | 10 | 12,5 |
| finishing | | | | | | |
| STAINLESS STEEL | | | | | | |
| polished stainless steel AISI 304 DIN 1.4301 | 87671 | 87672 | - | 87673 | 87674 | - |
| euro/m | 32,07 | 32,29 | - | 35,82 | 36,06 | - |

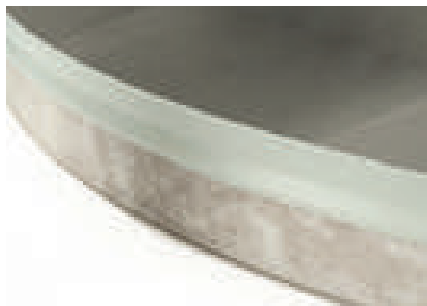

CPCVF/55/10 ash grey RAL 7038 embossed colour-coated aluminium

Complete the article code with H measure (for example CPCV/55/ for H=10 becomes CPCV/55/10)

PROTEC FLEX PRO FLEX LINE

length = 270 cm - pack 2 pcs

| ART. | H | |
|--------------------------------|------------------|--------------|
| | 10 | NEW 12,5 |
| finishing | CPCVF/55/ | |
| COLOUR-COATED ALUMINIUM | | |
| ash grey RAL 7038 | 87790 | - |
| ash grey RAL 7038 embossed | 87791 | 87793 |
| ancient grey | 87792 | 87794 |
| euro/m | 26,22 | 26,22 |

no partial packaging

For colours on request and other heights please contact our sales department

For a single piece, see sales conditions on page 288

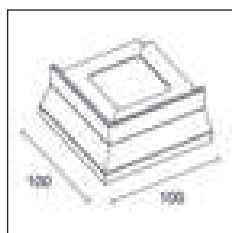

CPCV//E
CPCI//E

90° OUTSIDE CORNER

| pack 5 pcs | | H | | | | | | | | |
|--------------------------------|-----------|--------------|--------------|--------------|--------------|--------------|--------------|--------------|--------------|--------------|
| | | 10 | 12,5 | 21 | 10 | 12,5 | 21 | 10 | 12,5 | 21 |
| ART. | finishing | CPCV/55/ /E | | | CPCV/75/ /E | | | CPCV/95/ /E | | |
| COLOUR-COATED ALUMINIUM | | | | | | | | | | |
| white RAL 9003 | | 87817 | 87818 | - | 87827 | 87828 | - | 87837 | 87838 | - |
| ash grey RAL 7038 | | 87821 | 87822 | 87663 | 87831 | 87832 | 87664 | 87841 | 87842 | 87665 |
| ash grey RAL 7038 embossed | | 87894 | 87895 | - | 87896 | 87897 | - | 87898 | 87899 | - |
| dark brown RAL 8019 | | 87825 | 87826 | - | 87835 | 87836 | - | 87845 | 87846 | - |
| rust | | 87620 | 87621 | - | 87622 | 87623 | - | - | - | - |
| metal grey RAL 9006 | | 87730 | 87731 | - | 87733 | 87734 | - | 87736 | 87737 | - |
| aluminium grey RAL 9007 | | 87760 | 87761 | - | 87763 | 87764 | - | 87766 | 87767 | - |
| ancient grey | | 87877 | 87878 | - | 87879 | 87880 | - | 87881 | 87882 | - |
| euro/pc | | 28,10 | 28,10 | 31,96 | 28,10 | 28,10 | 31,96 | 28,10 | 28,10 | 31,96 |

90° OUTSIDE CORNER

| pack 5 pcs | | H | | | | | |
|--|-----------|--------------|--------------|-------------|--------------|--------------|------|
| | | 10 | 12,5 | 10 | 12,5 | 10 | 12,5 |
| ART. | finishing | CPCI/55/ /E | | CPCI/75/ /E | | CPCI/95/ /E | |
| STAINLESS STEEL | | | | | | | |
| polished stainless steel AISI 304 DIN 1.4301 | | 87801 | 87802 | - | 87803 | 87804 | - |
| euro/pc | | 44,05 | 44,05 | - | 44,05 | 44,05 | - |

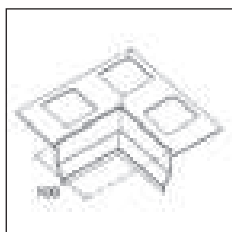

CPCV/55/ /I

90° INSIDE CORNER

| pack 5 pcs | | H | | |
|--------------------------------|-----------|--------------|--------------|---|
| | | 10 | 12,5 | |
| ART. | finishing | CPCV/55/ /I | | |
| COLOUR-COATED ALUMINIUM | | | | |
| ash grey RAL 7038 | | 87890 | 87891 | - |
| ash grey RAL 7038 embossed | | 87807 | 87808 | - |
| ancient grey | | 87892 | 87893 | - |
| euro/pc | | 30,93 | 30,93 | - |

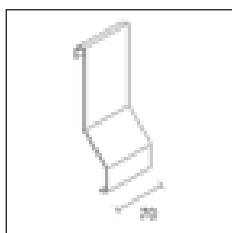

CPCV// /G
CPCI// /G

JUNCTION

| width = 70 mm - pack 5 pcs | | H | | | | | | | | |
|--------------------------------|-----------|-------------|-------------|-------------|-------------|-------------|-------------|-------------|-------------|-------------|
| | | 10 | 12,5 | 21 | 10 | 12,5 | 21 | 10 | 12,5 | 21 |
| ART. | finishing | CPCV/55/ /G | | | CPCV/75/ /G | | | CPCV/95/ /G | | |
| COLOUR-COATED ALUMINIUM | | | | | | | | | | |
| white RAL 9003 | | 87847 | 87848 | - | 87857 | 87858 | - | 87867 | 87868 | - |
| ash grey RAL 7038 | | 87851 | 87852 | 87666 | 87861 | 87862 | 87667 | 87871 | 87872 | 87668 |
| ash grey RAL 7038 embossed | | 87748 | 87749 | - | 87758 | 87759 | - | 87768 | 87769 | - |
| dark brown RAL 8019 | | 87853 | 87854 | - | 87863 | 87864 | - | 87873 | 87874 | - |
| rust | | 87624 | 87625 | - | 87626 | 87627 | - | - | - | - |
| metal grey RAL 9006 | | 87740 | 87741 | - | 87743 | 87744 | - | 87746 | 87747 | - |
| aluminium grey RAL 9007 | | 87770 | 87771 | - | 87773 | 87774 | - | 87776 | 87777 | - |
| ancient grey | | 87883 | 87884 | - | 87885 | 87886 | - | 87887 | 87888 | - |
| euro/pc | | 5,46 | 5,46 | 8,01 | 5,46 | 5,46 | 8,01 | 5,46 | 5,46 | 8,01 |

no partial packaging

JUNCTION

| width = 70 mm - pack 5 pcs | | H | | | | | |
|--|-----------|-------------|-------------|-------------|-------------|-------------|------|
| | | 10 | 12,5 | 10 | 12,5 | 10 | 12,5 |
| ART. | finishing | CPCI/55/ /G | | CPCI/75/ /G | | CPCI/95/ /G | |
| STAINLESS STEEL | | | | | | | |
| polished stainless steel AISI 304 DIN 1.4301 | | 87811 | 87812 | - | 87813 | 87814 | - |
| euro/pc | | 7,14 | 7,14 | - | 7,14 | 7,14 | - |

no partial packaging



CPCV/55/E + CPCV/55/G ancient grey colour-coated aluminium

For a single piece, see sales conditions on page 288

Protec CPCV/30/ is the solution for old terraces. The reduced dimensions of the protruding section allow to avoid removing the perimetral balustrades in case of refurbishment.



CPCV/30/ ancient grey colour-coated aluminium

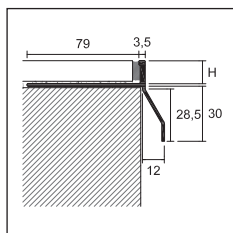

CPCV/30/

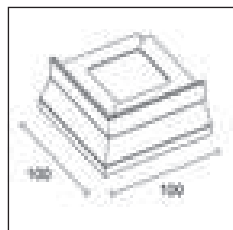

CPCV/30/ / E

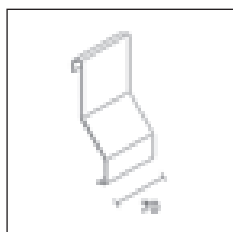

CPCV/30/ /G

PROTEC

length = 270 cm - pack 10 pcs H

| | 10 | 12,5 |
|--------------------------------|-------------------|-------------------|
| ART. | CPCV/30/10 | CPCV/30/12 |
| finishing | | |
| COLOUR-COATED ALUMINIUM | | |
| ash grey RAL 7038 | 87651 | 87652 |
| ash grey RAL 7038 embossed | 87655 | 87656 |
| ancient grey | 87653 | 87654 |
| euro/m | 13,08 | 13,47 |

90° OUTSIDE CORNER

pack 5 pcs H

| | 10 | 12,5 |
|--------------------------------|---------------------|---------------------|
| ART. | CPCV/30/10/E | CPCV/30/12/E |
| finishing | | |
| COLOUR-COATED ALUMINIUM | | |
| ash grey RAL 7038 | 87780 | 87781 |
| ash grey RAL 7038 embossed | 87784 | 87785 |
| ancient grey | 87782 | 87783 |
| euro/pc | 13,35 | 13,72 |

JUNCTION

width = 70 mm - pack 5 pcs H

| | 10 | 12,5 |
|--------------------------------|---------------------|---------------------|
| ART. | CPCV/30/10/G | CPCV/30/12/G |
| finishing | | |
| COLOUR-COATED ALUMINIUM | | |
| ash grey RAL 7038 | 87631 | 87632 |
| ash grey RAL 7038 embossed | 87635 | 87636 |
| ancient grey | 87633 | 87634 |
| euro/pc | 5,72 | 5,72 |

no partial packaging



CPCV/30/ /E ancient grey colour-coated aluminium

Complete the article code with H measure (for example CPCV/30/ for H=10 becomes CPCV/30/10)

For a single piece, see sales conditions on page 288

Protec CPNV is a series of edge profiles for the protection and the finishing of the outside edges of terraces and balconies. Available in colour-coated aluminium, they can be installed flush with the border or detached from it. Their special section makes them suitable for the protection of the borders of steps or sidewalks, since it hides the junction between the tread and the riser. Protec CPNV is also available in the bendable version CPNVF, provided with a special cutout that allows to bend the profile with a radius up to 40 cm.



CPNV/45/ ash grey RAL 7038 embossed colour-coated aluminium

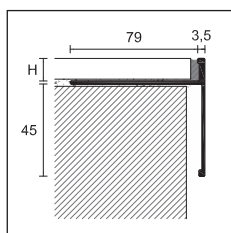

CPNV/45/

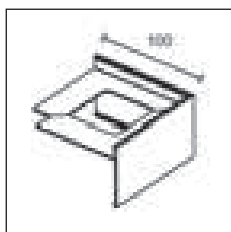

CPNV/45/ /E

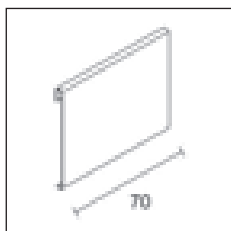

CPNV/45/ /G



CPNVF/45/10 ancient grey colour-coated aluminium

Complete the article code with H measure (for example CPNV/45/ for H=10 becomes CPNV/45/10)

For a single piece, see sales conditions on page 288

PROTEC

length = 270 cm - pack 10 pcs H

| ART. | finishing | 10 | 11 | 12,5 |
|------|-----------|----|----|------|
|------|-----------|----|----|------|

COLOUR-COATED ALUMINIUM

| | | | | | |
|---------------|-------------------|---|--------------|--------------|--------------|
| CPNV/45/ | ash grey | ■ | 87270 | 87271 | 87272 |
| | RAL 7038 embossed | | | | |
| | ancient grey | ■ | 87273 | 87274 | 87275 |
| euro/m | | | 16,37 | 16,50 | 16,63 |

white RAL 9003, dark brown RAL 8019, metal grey RAL 9006, aluminium grey RAL 9007, ash grey RAL 7038 and rust with a minimum of 270 meters, on request, without surcharge. For colours on request please contact our sales department.

90° OUTSIDE CORNER

pack 5 pcs H

| ART. | finishing | 10 | 11 | 12,5 |
|------|-----------|----|----|------|
|------|-----------|----|----|------|

COLOUR-COATED ALUMINIUM

| | | | | | |
|----------------|-------------------|---|--------------|--------------|--------------|
| CPNV/45/ /E | ash grey | ■ | 87276 | 87277 | 87278 |
| | RAL 7038 embossed | | | | |
| | ancient grey | ■ | 87279 | 87280 | 87281 |
| euro/pc | | | 19,14 | 19,14 | 19,14 |

JUNCTION

width = 70 mm - pack 5 pcs H

| ART. | finishing | 10 | 11 | 12,5 |
|------|-----------|----|----|------|
|------|-----------|----|----|------|

COLOUR-COATED ALUMINIUM

| | | | | | |
|----------------|-------------------|---|-------------|-------------|-------------|
| CPNV/45/ /G | ash grey | ■ | 87282 | 87283 | 87284 |
| | RAL 7038 embossed | | | | |
| | ancient grey | ■ | 87285 | 87286 | 87287 |
| euro/pc | | | 5,72 | 5,72 | 5,72 |

no partial packaging

PROTEC FLEX ~~PRO~~ FLEX LINE

length = 270 cm - pack 2 pcs H

| ART. | finishing | 10 | NEW 12,5 |
|------|-----------|----|----------|
|------|-----------|----|----------|

CPNVF/45/

COLOUR-COATED ALUMINIUM

| | | | |
|---------------|---|-------------------|--------------|
| ash grey | ■ | 87288 | 87290 |
| | | RAL 7038 embossed | |
| ancient grey | ■ | 87289 | 87291 |
| euro/m | | 24,09 | 24,38 |

no partial packaging

For colours on request and other heights please contact our sales department.

Protec CPGV is a perimetral profile for the protection and finishing of the outside edges of terraces and balconies. This profile is composed of a vertical part that facilitates the outflow of rainwater from the tiled surface and protects the border of the floor, and a sloping part equipped with holes for a further discharge of the water seeped under the tiles. This technical solution and the consequent drainage reduce the problems of freezing and thawing and the unsightly efflorescences on the tiles grouts. It can be used with tiles thicknesses up to 12,5 mm.



CPGV/55/10 ancient grey colour-coated aluminium

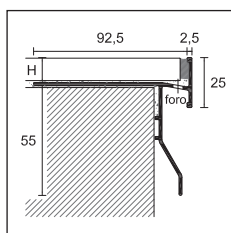

CPGV/55/

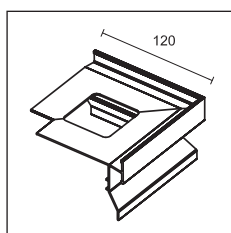

CPGV/55/ /E

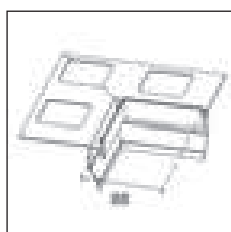

CPGV/55/ /I

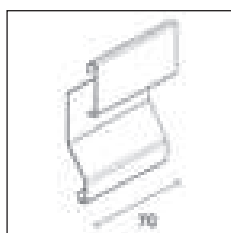

CPGV/55/ /G

PROTEC

length = 270 cm - pack 10 pcs

| | | H | |
|--------------------------------|--|-------------------|-------------------|
| | | 10 | 12,5 |
| ART. finishing | | CPGV/55/10 | CPGV/55/12 |
| COLOUR-COATED ALUMINIUM | | | |
| ash grey RAL 7038 | | 87580 | 87581 |
| ash grey RAL 7038 embossed | | 87578 | 87579 |
| metal grey RAL 9006 | | 87590 | 87591 |
| ancient grey | | 87582 | 87583 |
| white stone | | 87547 | 87548 |
| euro/m | | 24,39 | 24,39 |

white RAL 9003, dark brown RAL 8019 and aluminium grey RAL 9007 with a minimum of 270 meters, on request, without surcharge. For colours on request please contact our sales department.

90° OUTSIDE CORNER

pack 5 pcs

| | | H | |
|--------------------------------|--|---------------------|---------------------|
| | | 10 | 12,5 |
| ART. finishing | | CPGV/55/10/E | CPGV/55/12/E |
| COLOUR-COATED ALUMINIUM | | | |
| ash grey RAL 7038 | | 87584 | 87585 |
| ash grey RAL 7038 embossed | | 87595 | 87596 |
| metal grey RAL 9006 | | 87592 | 87593 |
| ancient grey | | 87586 | 87587 |
| white stone | | 87536 | 87537 |
| euro/pc | | 31,69 | 31,69 |

90° INSIDE CORNER

pack 5 pcs

| | | H | |
|--------------------------------|--|---------------------|---------------------|
| | | 10 | 12,5 |
| ART. finishing | | CPGV/55/10/I | CPGV/55/12/I |
| COLOUR-COATED ALUMINIUM | | | |
| ancient grey | | 87566 | 87567 |
| white stone | | 87538 | 87539 |
| euro/pc | | 34,52 | 34,52 |

JUNCTION

width = 70 mm - pack 5 pcs

| | | H | |
|--------------------------------|--|---------------------|---------------------|
| | | 10 | 12,5 |
| ART. finishing | | CPGV/55/10/G | CPGV/55/12/G |
| COLOUR-COATED ALUMINIUM | | | |
| ash grey RAL 7038 | | 87610 | 87610 |
| ash grey RAL 7038 embossed | | 87612 | 87612 |
| metal grey RAL 9006 | | 87594 | 87594 |
| ancient grey | | 87611 | 87611 |
| white stone | | 87528 | 87528 |
| euro/pc | | 7,68 | 7,68 |

no partial packaging

For a single piece, see sales conditions on page 288

Protec CPQV is a perimetral profile for the protection and finishing of the outside edges of terraces and balconies. This profile is composed of a vertical part that covers the border of the floor and facilitates the outflow of rainwater from the tiled surface, and a sloping part equipped with holes for a further discharge of the water seeped under the tiles. This technical solution and the consequent drainage reduce the problems of freezing and thawing and the unsightly efflorescences on the tiles grouts. It can be used with tiles thicknesses up to 12,5 mm.

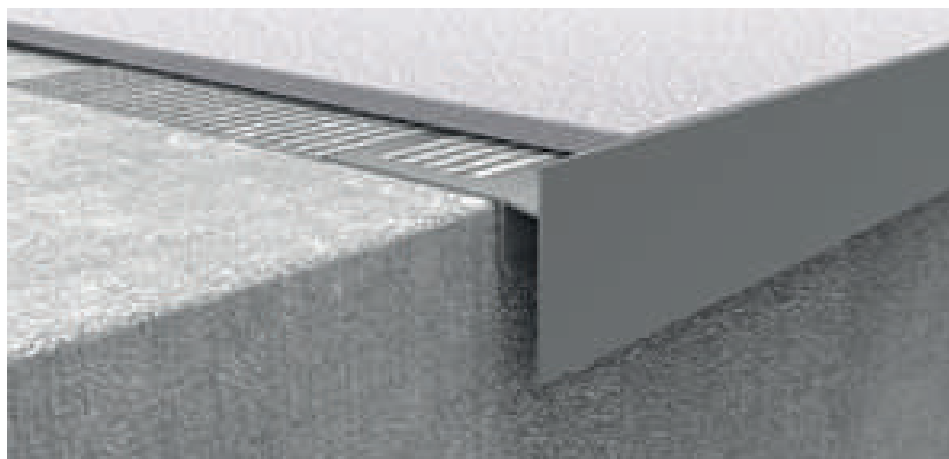

CPQV/50/10 ash grey RAL 7038 embossed colour-coated aluminium

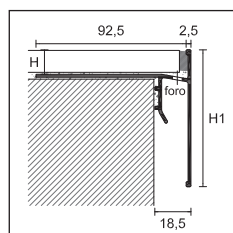

CPQV

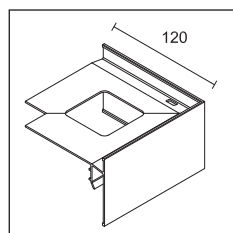

CPQV/I/E

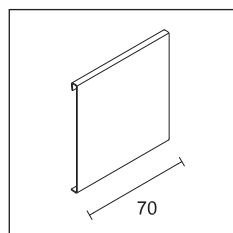

CPQV/I/G



CPQV ash grey RAL 7038

Complete the article code with H measure (for example CPQV/50/ for H=12,5 becomes CPQV/50/12)

For a single piece, see sales conditions on page 288

NEW PROTEC

length = 270 cm - pack 10 pcs

| ART. | finishing | H | | | |
|--------------------------------|----------------------------|-------------------------|--------------|-------------------------|--------------|
| | | 10 | 12,5 | 10 | 12,5 |
| | | CPQV/50/ (H1=50) | | CPQV/70/ (H1=70) | |
| COLOUR-COATED ALUMINIUM | | | | | |
| | ash grey RAL 7038 | 86960 | 86961 | 86962 | 86963 |
| | ash grey RAL 7038 embossed | 86964 | 86965 | 86966 | 86967 |
| | metal grey RAL 9006 | 86968 | 86969 | 86970 | 86971 |
| | ancient grey | 86972 | 86973 | 86974 | 86975 |
| | white ST | 86976 | 86977 | 86978 | 86979 |
| | euro/m | 24,26 | 24,26 | 25,73 | 25,73 |

white RAL 9003, dark brown RAL 8019 and aluminium grey RAL 9007 with a minimum of 270 meters, on request, without surcharge. For colours on request please contact our sales department.

NEW 90° OUTSIDE CORNER

pack 5 pcs

| ART. | finishing | H | | | |
|--------------------------------|----------------------------|--------------------|--------------|--------------------|--------------|
| | | 10 | 12,5 | 10 | 12,5 |
| | | CPQV/50/ /E | | CPQV/70/ /E | |
| COLOUR-COATED ALUMINIUM | | | | | |
| | ash grey RAL 7038 | 86980 | 86981 | 86982 | 86983 |
| | ash grey RAL 7038 embossed | 86984 | 86985 | 86986 | 86987 |
| | metal grey RAL 9006 | 86988 | 86989 | 86990 | 86991 |
| | ancient grey | 86992 | 86993 | 86994 | 86995 |
| | white ST | 86996 | 86997 | 86998 | 86999 |
| | euro/pc | 31,71 | 31,71 | 31,71 | 31,71 |

NEW JUNCTION

width = 70 mm - pack 5 pcs

| ART. | finishing | H | |
|--------------------------------|----------------------------|-------------|-------------|
| | | CPQV/50/G | CPQV/70/G |
| COLOUR-COATED ALUMINIUM | | | |
| | ash grey RAL 7038 | 87000 | 87001 |
| | ash grey RAL 7038 embossed | 87002 | 87003 |
| | metal grey RAL 9006 | 87004 | 87005 |
| | ancient grey | 87006 | 87007 |
| | white ST | 87008 | 87009 |
| | euro/pc | 5,72 | 5,72 |

no partial packaging

Protec CPEV and CPEI are a series of edge reversible profiles for the protection and finishing of the outside edges of terraces and balconies.

Available in stainless steel and colour-coated aluminium, they can be installed flush with the border or detached from it. They can be used with tiles or marble thicknesses from 11 to 32 mm.

The particular section is recommended to protect the stair nosing and sidewalk edge, hiding the connection between tread and riser.



CPEV/45/12 colour-coated aluminium ancient grey

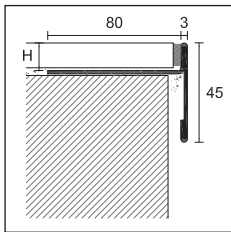

CPEV/45/

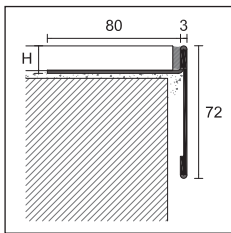

CPEV/72/

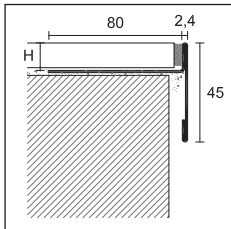



CPEI/

PROTEC

| | | | | |
|-------------------------------|-----------------|-------------|-----------|-----------------|
| length = 270 cm - pack 10 pcs | H | | | |
| | 11 | 12,5 | 15 | 20 |
| ART. | CPEV/45/ | | | CPEV/72/ |

| | | | | |
|------------------|--|--|--|--|
| finishing | | | | |
|------------------|--|--|--|--|

COLOUR-COATED ALUMINIUM

| | | | | | | |
|---------------------|---|--------------|--------------|--------------|--------------|--------------|
| ash grey RAL 7038 |  | 87530 | 87550 | 87551 | 87552 | 87252 |
| metal grey RAL 9006 |  | 87531 | 87540 | 87541 | 87542 | - |
| ancient grey |  | 87532 | 87553 | 87554 | 87555 | - |
| euro/m | | 20,44 | 20,44 | 20,44 | 20,44 | 23,14 |

for CPEV/72 white RAL 9003, dark brown RAL 8019, metal grey RAL 9006, aluminium grey RAL 9007, ancient grey, ash grey RAL 7038 embossed and rust with minimum 270 meters, on request, without surcharge. For different colours, please contact our Sales Department. For CPEV/45 white RAL 9003, dark brown RAL 8019, aluminium grey RAL 9007, ash grey RAL 7038 embossed and rust with minimum 270 meters, on request, without surcharge. For colours on request please contact our sales department.

PROTEC

| | | | |
|-------------------------------|-----------------|-----------|-----------|
| length = 270 cm - pack 10 pcs | H | | |
| | 12,5 | 15 | 20 |
| ART. | CPEI/45/ | | |

STAINLESS STEEL

| | | | | | |
|---|---|---|--------------|--------------|--------------|
| polished stainless steel AISI 304 DIN 1.4301 |  | - | 87570 | 87571 | 87572 |
| euro/m | | - | 31,41 | 31,41 | 31,41 |

Complete the article code with H measure (for example CPEV/45/ for H=12,5 becomes CPEV/45/12)

For a single piece, see sales conditions on page 288

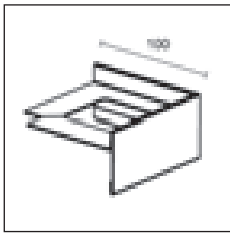

CPEV// /E
CPEI// /E

90° OUTSIDE CORNER

| pack 5 pcs | | H | | | | |
|--------------------------------|--|--------------|--------------|--------------|--------------|--------------|
| | | 11 | 12,5 | 15 | 20 | 12,5 |
| ART. | | CPEV/45/ /E | | | | CPEV/72/ /E |
| finishing | | | | | | |
| COLOUR-COATED ALUMINIUM | | | | | | |
| ash grey RAL 7038 | | 87533 | 87556 | 87557 | 87558 | 87255 |
| metal grey RAL 9006 | | 87534 | 87543 | 87544 | 87545 | - |
| ancient grey | | 87535 | 87559 | 87560 | 87561 | - |
| euro/pc | | 28,20 | 28,20 | 28,20 | 28,20 | 29,44 |

90° OUTSIDE CORNER

| pack 5 pcs | | H | | | | |
|---|--|-------------|--------------|--------------|--------------|--|
| | | 12,5 | 15 | 20 | | |
| ART. | | CPEI/45/ /E | | | | |
| STAINLESS STEEL | | | | | | |
| polished stainless steel AISI 304 DIN 1.4301 | | - | 87573 | 87574 | 87575 | |
| euro/pc | | - | 38,55 | 38,55 | 38,55 | |

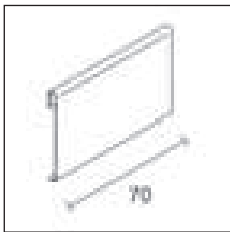

CPEV// /G
CPEI// /G

JUNCTION

| width = 70 mm - pack 5 pcs | | H | | | | |
|--------------------------------|--|-------------|-------------|-------------|-------------|-------------|
| | | 11 | 12,5 | 15 | 20 | 12,5 |
| ART. | | CPEV/45/ /G | | | | CPEV/72/ /G |
| finishing | | | | | | |
| COLOUR-COATED ALUMINIUM | | | | | | |
| ash grey RAL 7038 | | 87562 | 87562 | 87562 | 87562 | 87258 |
| metal grey RAL 9006 | | 87546 | 87546 | 87546 | 87546 | - |
| ancient grey | | 87563 | 87563 | 87563 | 87563 | - |
| euro/pc | | 5,72 | 5,72 | 5,72 | 5,72 | 5,72 |

no partial packaging

JUNCTION

| width = 70 mm - pack 5 pcs | | H | | | | |
|---|--|-------------|-------------|-------------|-------------|--|
| | | 12,5 | 15 | 20 | | |
| ART. | | CPEI/45/ /G | | | | |
| STAINLESS STEEL | | | | | | |
| polished stainless steel AISI 304 DIN 1.4301 | | - | 87576 | 87576 | 87576 | |
| euro/pc | | - | 7,14 | 7,14 | 7,14 | |

no partial packaging



Complete the article code with H measure
(for example CPEV/45/ for H=12,5 becomes
CPEV/45/12)

For a single piece, see sales conditions on page 288 CPEV/45/12/E + CPEV/45/12/G ancient grey colour-coated aluminium

cerfix® protec

Protec CPHA - CPHV is an edge profile in anodised and colour-coated aluminium for terraces, balconies and sidewalks. The shape allows the outflow of water, avoiding the direct contact with the screed. Installed along the perimeter, it allows to outline the ceramic tiles and to protect the border in many fields of use. It can be used with tiles thicknesses up to 21 mm.



CPHA/10 silver anodised aluminium

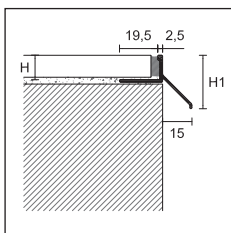

CPHA/
CPHV/

PROTEC

length = 270 cm - pack 10 pcs

| | | H (H1) | | | |
|--------------------------------|----------------------------|-------------|-------------|-------------|-------------|
| ART. | finishing | 8 (23) | 10 (25) | 12,5 (27) | 21 (36) |
| ALUMINIUM | | | | | |
| CPHA/ | silver anodised | 87599 | 87600 | 87601 | 87602 |
| | <i>euro/m</i> | 5,39 | 5,49 | 5,67 | 6,99 |
| COLOUR-COATED ALUMINIUM | | | | | |
| | ash grey RAL 7038 | - | 87606 | 87607 | 87608 |
| CPHV/ | ash grey RAL 7038 embossed | - | 87637 | 87638 | - |
| | ancient grey | - | 87639 | 87640 | - |
| | <i>euro/m</i> | - | 6,99 | 7,19 | 8,75 |

white RAL 9003, dark brown RAL 8019, metal grey RAL 9006, aluminium grey RAL 9007 and ancient grey with a minimum of 270 meters, on request, without surcharge. For colours on request please contact our sales department.

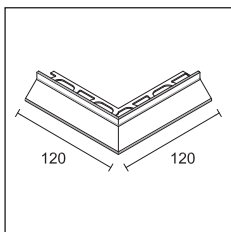

CPHA/ E
CPHV/ E

90° OUTSIDE CORNER

dimension = 12x12 cm - pack 5 pcs

| | | H (H1) | | | |
|--------------------------------|----------------------------|--------------|--------------|--------------|--------------|
| ART. | finishing | 8 (23) | 10 (25) | 12,5 (27) | 21 (36) |
| ALUMINIUM | | | | | |
| CPHA/ E | silver anodised | 87564 | 87565 | 87597 | 87598 |
| | <i>euro/pc</i> | 13,72 | 13,72 | 13,72 | 13,72 |
| COLOUR-COATED ALUMINIUM | | | | | |
| | ash grey RAL 7038 | - | 87603 | 87604 | 87609 |
| CPHV/ E | ash grey RAL 7038 embossed | - | 87641 | 87642 | - |
| | ancient grey | - | 87643 | 87644 | - |
| | <i>euro/pc</i> | - | 13,72 | 13,72 | 13,72 |

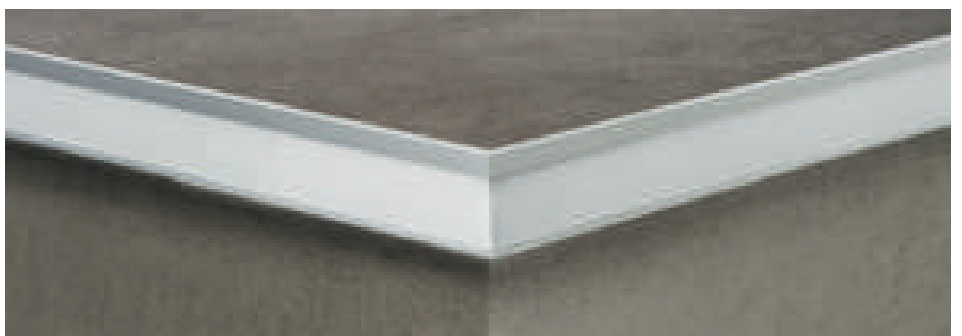

CPHA/ E silver anodised aluminium

Complete the article code with H measure (for example CPHA/ for H=10 becomes CPHA/10)

For a single piece, see sales conditions on page 288

Protec CPLV is a line of perimetral profiles in colour-coated aluminium, for the protection and finishing of the borders of outdoor raised floors, terraces or balconies. They are composed of a drilled base CPLB to be screwed to the supports, or, as an alternative, a cut base CPLB/2 for glued tiles, and a visible profile to be fixed with adhesive, available in 3 different heights according to the floor thickness. There are also special accessories for the creation of external corners and junctions.



CPLB + CPLV/60 ash grey RAL 7038 colour-coated aluminium

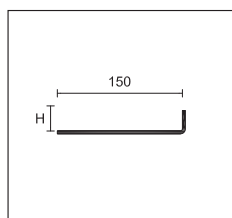
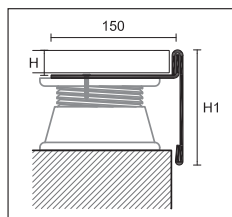

CPLB
base for raised
floors

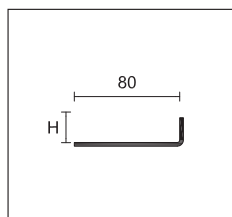

CPLB/2
punched base
for tiled floors

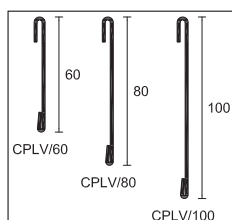

CPLV/

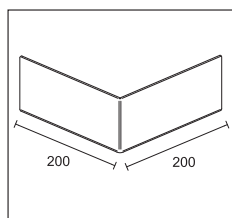

CPLV/ E

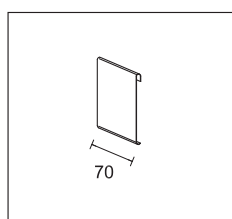

CPLV/ G

PROTEC

length = 270 cm - pack 10 pcs

H

BASE

ART. finishing

20

ALUMINIUM

| | | | |
|-------------------|-------------------|--|--------------|
| CPLB | natural aluminium | | 86900 |
| | euro/m | | 21,40 |
| NEW CPLB/2 | natural aluminium | | 86901 |
| | euro/m | | 11,64 |

CPLB with draining holes available on request, extra euro/m 2,71
CPLB and CPLB/2 in 15 and 25 mm height available on request
possibility to choose noise-proof rubber PPL/GM, see page 253

PROTEC

length = 270 cm - pack 10 pcs

H1

FRONT

ART. finishing

60

80

100

NEW COLOUR-COATED ALUMINIUM

| | | | | | |
|--------------|-------------------|--|--------------|--------------|--------------|
| CPLV/ | ash grey RAL 7038 | | 86902 | 86904 | 86906 |
| | ancient grey | | 86903 | 86905 | 86907 |
| | stone | | 86908 | 86909 | 86910 |
| | greige | | 86911 | 86912 | 86913 |
| | sand | | 86914 | 86915 | 86916 |
| | beige | | 86917 | 86918 | 86919 |
| | euro/m | | 15,86 | 18,38 | 20,75 |

white RAL 9003, dark brown RAL 8019, metal grey RAL 9006, aluminium grey RAL 9007, ash grey RAL 7038 embossed and rust with a minimum of 270 meters, on request, without surcharge. For other colours please contact our sales department.

90° OUTSIDE CORNER

pack 5 pcs

H1

ART. finishing

60

80

100

NEW COLOUR-COATED ALUMINIUM

| | | | | | |
|----------------|-------------------|--|--------------|--------------|--------------|
| CPLV/ E | ash grey RAL 7038 | | 86920 | 86922 | 86924 |
| | ancient grey | | 86921 | 86923 | 86925 |
| | stone | | 86926 | 86927 | 86928 |
| | greige | | 86929 | 86931 | 86933 |
| | sand | | 86935 | 86936 | 86937 |
| | beige | | 86938 | 86939 | 86940 |
| | euro/pc | | 26,95 | 26,95 | 26,95 |

NEW JUNCTION

width = 70 mm - pack 5 pcs

H1

ART. finishing

60

80

100

COLOUR-COATED ALUMINIUM

| | | | | | |
|----------------|-------------------|--|-------------|-------------|-------------|
| CPLV/ G | ash grey RAL 7038 | | 86930 | 86932 | 86934 |
| | ancient grey | | 86941 | 86942 | 86943 |
| | stone | | 86944 | 86945 | 86946 |
| | greige | | 86947 | 86948 | 86949 |
| | sand | | 86950 | 86951 | 86952 |
| | beige | | 86953 | 86954 | 86955 |
| | euro/pc | | 5,46 | 5,46 | 5,46 |

no partial packaging

For a single piece, see sales conditions on page 288





stair nosing profiles

Protection, finishing and safety. Protect and Prostep are two ranges of stair nosing profiles for stairs for public and private use.

stair nosing profiles

cerfix® prostep

Prostep SGA, SGI, SGN and SGK are profiles for the realization and protection of ceramic, marble and stone steps. Thanks to the rounded section, they give elegance to the steps. The models in chromium-plated brass and anodized aluminium are not recommended in case of intense foot traffic, while those in stainless steel are particularly suitable for heavy foot traffic.



SGI/11 polished stainless steel AISI 304 DIN 1.4301

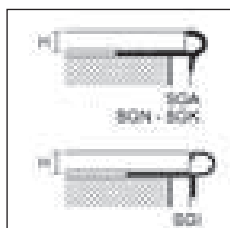

PROSTEP

length = 270 cm - pack 10 pcs

| | | H | | | |
|------------------------------|--|--------------|--------------|--------------|-------------|
| ART. | finishing | 7 | 9 | 11 | 13 |
| ALUMINIUM | | | | | |
| SGA/ | silver anodised | 94965 | 94966 | 94967 | 94968 |
| | <i>euro/m</i> | 7,98 | 8,45 | 8,91 | 9,37 |
| STAINLESS STEEL | | | | | |
| SGI/ | polished stainless steel AISI 304 DIN 1.4301 | - | 94922 | 94924 | - |
| | <i>euro/m</i> | - | 12,93 | 14,01 | - |
| BRASS | | | | | |
| SGN/ | natural brass | 94970 | 94971 | 94972 | - |
| | <i>euro/m</i> | 23,58 | 24,38 | 25,98 | - |
| CHROMIUM-PLATED BRASS | | | | | |
| SGK/ | chromium-plated brass | 94980 | 94981 | 94982 | - |
| | <i>euro/m</i> | 30,64 | 31,40 | 32,87 | - |

individually packed - art. SGK/9 and SGK/11 pack 5 pcs

PPDESIGN

Prostep SMA and SM are aluminium and brass profiles for realization and protection of ceramic, marble and stone steps. Thanks to the grooved top part, they are consistent with DIN 51131 law concerning non-slip stair nosing.



SMA/4,5 natural aluminium

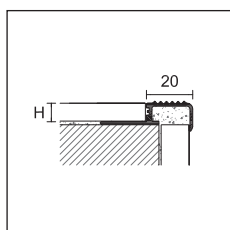

SMA/
SM/

PROSTEP

length= 270 cm - pack 10 pcs

| | | H | | | | |
|------------------|-------------------|-------------|-------------|--------------|-------------|--------------|
| ART. | finishing | 4,5 | 8 | 10 | 11 | 12,5 |
| ALUMINIUM | | | | | | |
| | natural aluminium | 93967 | 93969 | 93970 | 93979 | 93971 |
| SMA/ | <i>euro/m</i> | 6,26 | 7,00 | 7,34 | 7,57 | 7,74 |
| | silver anodised | 93975 | 93976 | 93977 | 93980 | 93978 |
| | <i>euro/m</i> | 7,52 | 8,24 | 8,56 | 8,79 | 9,00 |
| BRASS | | | | | | |
| SM/ | natural brass | - | - | 93972 | - | 93973 |
| | <i>euro/m</i> | - | - | 28,99 | - | 30,65 |

individually packed

Complete the article code with H measure (for example for SGA/ for H=11 becomes SGA/11)

For a single piece, see sales conditions on page 288

Protrim IPI/ are minimal profiles in aluminium or stainless steel suitable for the edging of external corners that need the 45 degrees cut. These profiles allow a perfect laying both on coverings and on stairs or platforms in ceramic or wood.



IPA/11 silver anodised aluminium

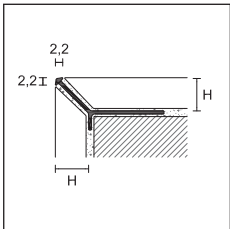

IPA/
IPB/



IPI/

Prostep SNG and SN are aluminium and brass profiles for realization and protection of ceramic, marble and stone steps.



SNG/10 silver anodised aluminium

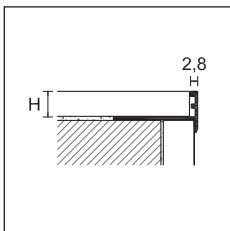

SNG/
SN/

PROTRIM IP

length = 270 cm - pack 20 pcs

| | | H | | | |
|------------------|------------------------|-------|-------|-------|-------|
| ART. | finishing | 4,5 | 8 | 11 | 15 |
| ALUMINIUM | | | | | |
| IPA/ | silver anodised | 95006 | 95178 | 95181 | 95185 |
| | euro/m | 4,17 | 4,28 | 4,28 | 4,50 |
| IPB/ | bright polished silver | 95008 | - | - | - |
| | euro/m | 7,02 | - | - | - |

individually packed

PROTRIM IP

length = 270 cm - pack 20 pcs

| | | H | | | |
|------------------------|---------------------------------------|-------|-------|-------|-------|
| ART. | finishing | 7 | 8 | 11 | 12,5 |
| STAINLESS STEEL | | | | | |
| IPI/ | stainless steel AISI 304 - DIN 1.4301 | 95169 | 95170 | 95173 | 95174 |
| | euro/m | 8,45 | 8,73 | 9,24 | 9,63 |

individually packed

PROSTEP

length = 270 cm - pack 20 pcs

| | | H | | | |
|------------------|-------------------|-------|-------|-------|-------|
| ART. | finishing | 8 | 10 | 12,5 | 15 |
| ALUMINIUM | | | | | |
| | natural aluminium | 90040 | 90042 | 90044 | 90046 |
| SNG/ | euro/m | 3,12 | 3,20 | 3,38 | 3,68 |
| | silver anodised | 90041 | 90043 | 90045 | 90047 |
| | euro/m | 4,24 | 4,34 | 4,46 | 4,94 |
| SN/ | natural brass | 93991 | 93992 | 93993 | - |
| | euro/m | 14,21 | 14,66 | 15,18 | - |

individually packed - SN/ pack 10 pcs

Complete the article code with H measure (for example IPA/ for H=11 becomes IPA/11)

For a single piece, see sales conditions on page 288

stair nosing profiles

cerfix® prostep

Prostep SAR and SIR are stair nosing profiles in aluminium and stainless steel, suitable for the protections of steps or pavements. Thanks to the reversible shapes, these two models can be used for tiles of four different thicknesses.



SAR/10/12 silver anodised aluminium



SIR/10/12 stainless steel AISI 304 DIN 1.4301

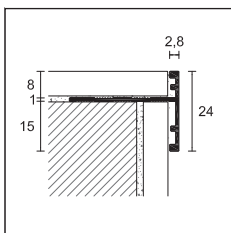

SAR/8

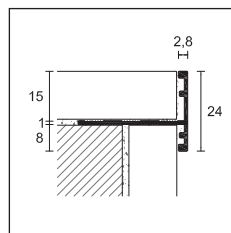

SAR/15

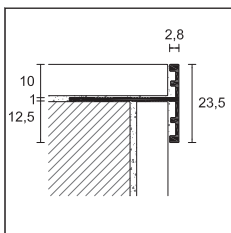

SAR/10

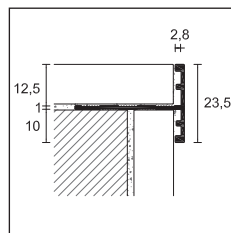

SAR/12

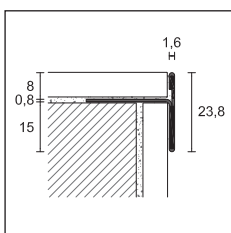

SIR/8
SIRS/8

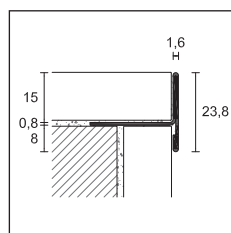

SIR/15
SIRS/15

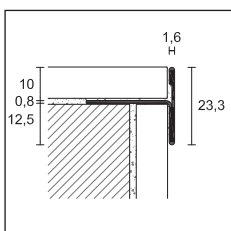

SIR/10
SIRS/10

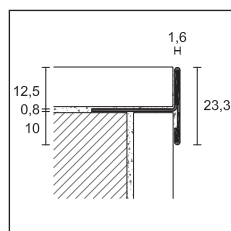

SIR/12
SIRS/12

PROSTEP

length = 270 cm - pack 10 pcs

ART. finishing

ALUMINIUM

| | | | |
|------------------|-----------------|--|-------------|
| SAR/8/15 | silver anodised | | 93956 |
| | <i>euro/m</i> | | 6,99 |
| SAR/10/12 | silver anodised | | 93958 |
| | <i>euro/m</i> | | 6,99 |

individually packed

PROSTEP

length = 270 cm - pack 10 pcs

ART. finishing

STAINLESS STEEL

| | | | |
|-------------------|---|--|--------------|
| SIR/8/15 | polished stainless steel AISI 304 DIN 1.4301 | | 93952 |
| | <i>euro/m</i> | | 15,04 |
| SIR/10/12 | polished stainless steel AISI 304 DIN 1.4301 | | 93954 |
| | <i>euro/m</i> | | 15,04 |
| SIRS/8/15 | satin stainless steel AISI 304 DIN 1.4301 | | 93953 |
| | <i>euro/m</i> | | 16,89 |
| SIRS/10/12 | satin stainless steel AISI 304 DIN 1.4301 | | 93955 |
| | <i>euro/m</i> | | 16,89 |

individually packed

Prostep SIS is a stainless steel profile for the realization and protection of ceramic, marble and stone steps. Thanks to the satin and knurled tread, it is compliant with non-slip stair regulation DIN 51131. Prostep SIS is particularly suitable for the protection of steps subject to heavy pedestrian traffic.

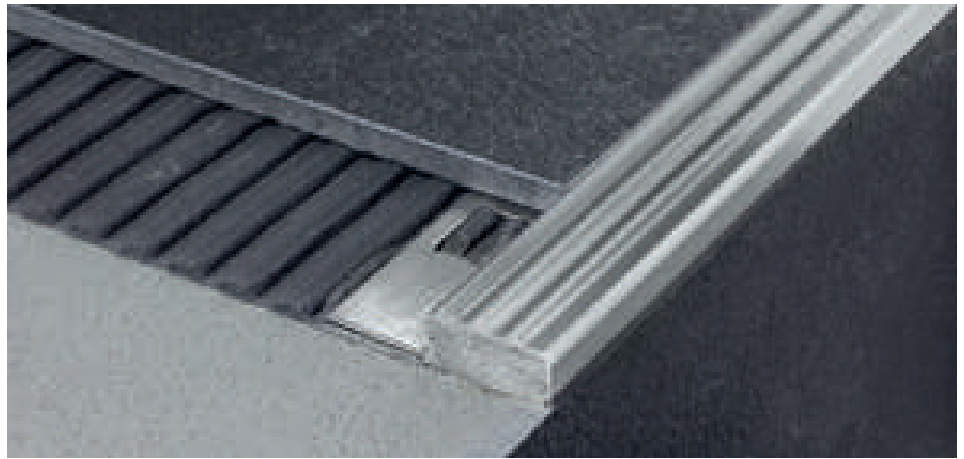

SIS/10 satin stainless steel AISI 304 - DIN 1.4301

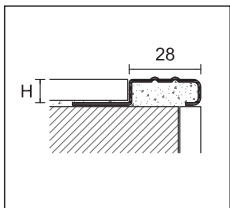

SIS/

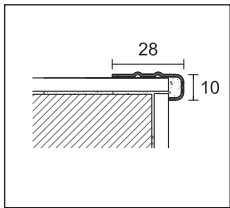

SIS/10/SF

PROSTEP

length = 270 cm - pack 10 pcs

| | | H | | |
|------------------------|---|-------|-------|-------|
| ART. | finishing | 10 | 11 | 12,5 |
| STAINLESS STEEL | | | | |
| SIS/ | satin stainless steel AISI 304 DIN 1.4301 | 93987 | 93989 | 93988 |
| | euro/m | 19,05 | 19,22 | 19,35 |
| SIS/10/SF | satin stainless steel AISI 304 DIN 1.4301 | 93997 | - | - |
| | euro/m | 12,78 | - | - |

individually packed

Prostep SIX is a stainless steel profile for realization and protection of ceramic, marble and stone steps. They are in accordance with DIN 51131 regulation of non-slip stair nosing thanks to the application of non-slip strips: Safety-Step. It is particularly suitable to protect the stairs in case of high pedestrian traffic.

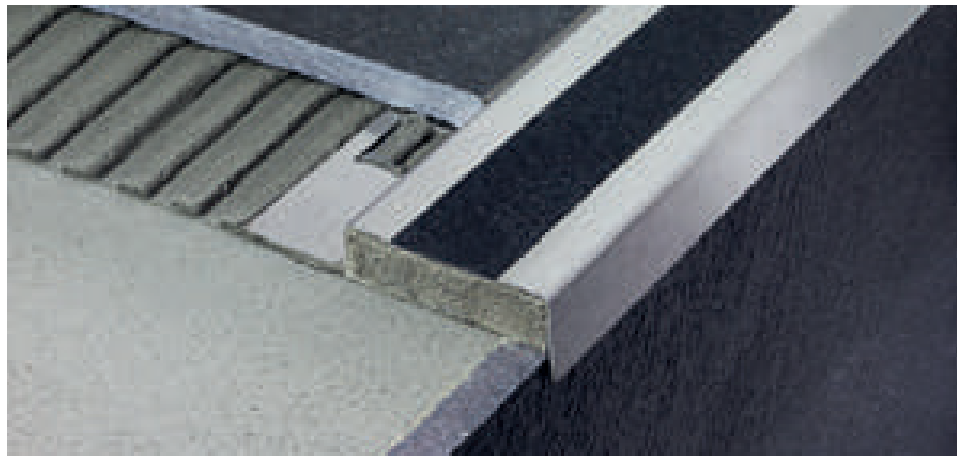

SIX/10 satin stainless steel AISI 304 - DIN 1.4301 + black slip-resistant 25 mm

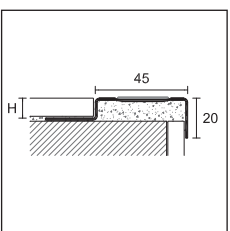

SIX/

PROSTEP

length = 270 cm - pack 10 pcs

| | | H | | |
|------------------------|--|-------|-------|-------|
| ART. | finishing | 8 | 10 | 12,5 |
| STAINLESS STEEL | | | | |
| SIX/ | satin stainless steel AISI 304 DIN 1.4301 + black slip-resistant 25 mm | 93981 | 93982 | 93983 |
| | euro/m | 25,27 | 27,14 | 29,00 |

individually packed

Complete the article code with H measure (for example SIS/ for H=10 becomes SIS/10)

For a single piece, see sales conditions on page 288

stair nosing profiles

cerfix® prostep

Prostep Wood is a line of profiles in solid wood and aluminium base for the realization and protection of ceramic, wood or cotto tile steps. Available in different heights, we recommend to paint it immediately after installation for the best finishing and durability results.



SWA/10 oak

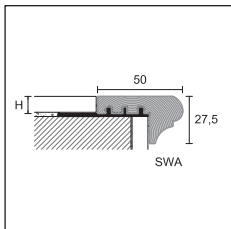

SWA/

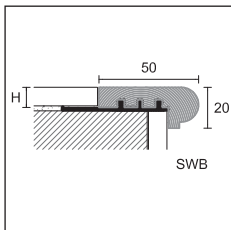

SWB/

PROSTEP WOOD

length = 270 cm - pack 5 pcs

| | | H | | |
|------|-----------|-------|-------|-------|
| ART. | finishing | 10 | 12,5 | 15 |
| SWA/ | oak | 90480 | 90484 | 90488 |
| | euro/m | 47,02 | 48,43 | 50,01 |
| SWB/ | oak | 90512 | 90516 | - |
| | euro/m | 37,57 | 39,00 | - |

art. SWA and SWB available in length 90-135 cm with a minimum order of 12 pcs and a surcharge euro/pc 3,00.

Prostep SP is a line of profiles in PVC with aluminium base for realization and protection of ceramic, stone or brick floors. The grooved PVC insert is in accordance with DIN 51131 regulation of non-slip stair nosing.



SP/10 + Black PVC

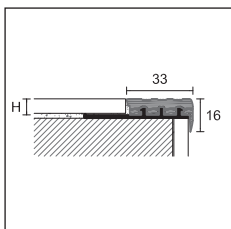

SP/

PROSTEP

length = 270 cm - pack 10 pcs

| | | H | | |
|------|-----------------------|-------|-------|-------|
| ART. | finishing | 8 | 10 | 12,5 |
| SP/ | aluminium + black PVC | 95200 | 95210 | 95220 |
| | euro/m | 14,66 | 15,70 | 16,97 |

Complete the article code with H measure
(for example SWA/ for H=10 becomes SWA/10)

For a single piece, see sales conditions on page 288

Prostep SA and SB is a line of profiles in PVC with aluminium base for realization and protection of ceramic, stone or brick floors. The grooved PVC insert is in accordance with DIN 51131 regulation of non-slip stair nosing.



SB/10 aluminium + dark grey PVC

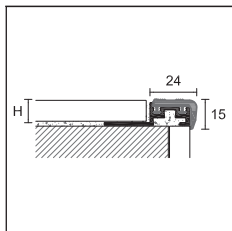

SA/

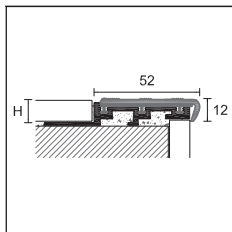

SB/

Prostep 111 and 75 are anodised aluminium profiles for realization and protection of stairs with floors with small thickness. They are suitable also for LVT floorings.



111/4/F silver anodised aluminium



75/F silver anodised aluminium

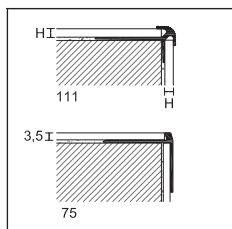

PROTECT

length = 270 cm - pack 20 pcs

| | | H | | | |
|------------------|-----------------|-------|-------|-------|-------|
| ART. | finishing | 2,5 | 4,5 | 5 | 6 |
| ALUMINIUM | | | | | |
| 111/ /F | silver anodised | 75782 | 75784 | 75785 | 75786 |
| | euro/m | 6,77 | 7,13 | 7,38 | 7,67 |

PROTECT

length = 340 cm - pack 20 pcs

| | | H |
|------------------|-----------------|-------|
| ART. | finishing | 3,5 |
| ALUMINIUM | | |
| 75/F | silver anodised | 75388 |
| | euro/m | 6,45 |

Complete the article code with H measure (for example SA/ for H=8 becomes SA/8)

For a single piece, see sales conditions on page 288

stair nosing profiles

protect

Protect 73, 74 and 58 are profiles for protection of step edge in wood, ceramic or marble already laid.

Protec 87, 370 and 373 are in accordance with DIN 51131 regulation of non-slip stair nosing. They are available in version with the holes and self-adhesive.

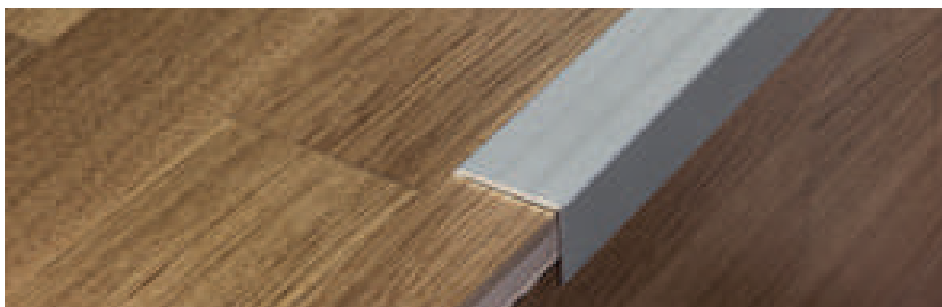

74/SF silver anodised aluminium

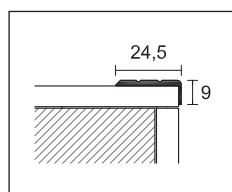

73/

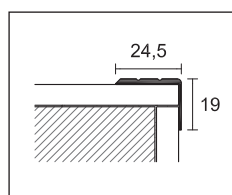

74/

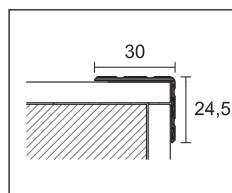

58/

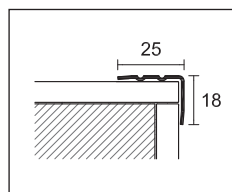

74/IF

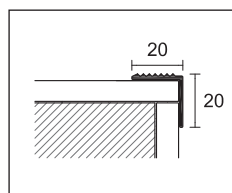

87/
370/

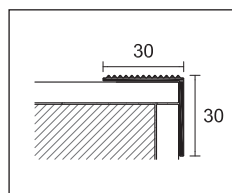

373/

Complete the article code with F=drilled, A/AD=adhesive, SF=undrilled, CV=screws (eg. 73/F drilled becomes 73/F)



 packaging in blister no partial packaging

For a single piece, see sales conditions on page 288

PROTECT



| | | | | | | | |
|-----------|--------|----|---|--|-----|----|---|
| pack | 30 pcs | | | 10 pcs / blister  | | | |
| length cm | 270 | | | 90 | 100 | | - |
| ART. | 73/ | | | 473/ | | | - |
| finishing | F | SF | A | CV | AD | CV | - |

ALUMINIUM

| | | | | | | | | |
|-----------------|---|-------|-------|-------|-------|-------|-------|---|
| silver anodised |  | 75208 | 75209 | 75238 | 21422 | 21434 | 00337 | - |
| gold anodised |  | 75218 | - | 75248 | 21423 | 21435 | 00338 | - |
| bronze anodised |  | - | - | 75258 | - | - | - | - |
| euro/m | | 3,84 | 3,69 | 5,06 | - | - | - | - |
| euro/pc | | - | - | - | 4,58 | 5,45 | 4,97 | - |

| | | | | | | | | | |
|-----------|---------|--------|---|----|--|----|----|--------|---|
| pack | 20 pcs. | 30 pcs | | | 10 pcs / blister  | | | 20 pcs | |
| ART. | 58/ | 74/ | | | 474/ | | | 74/1 | |
| finishing | A | - | F | SF | A | CV | AD | CV | F |

ALUMINIUM

| | | | | | | | | | | |
|-----------------|---|-------|---|-------|-------|-------|-------|-------|-------|---|
| silver anodised |  | 75900 | - | 75268 | 75269 | 75298 | 21512 | 21524 | 00390 | - |
| gold anodised |  | - | - | 75278 | - | 75308 | 21513 | 21525 | 00392 | - |
| bronze anodised |  | - | - | - | - | 75318 | - | - | - | - |
| euro/m | | 6,25 | - | 4,41 | 4,26 | 5,63 | - | - | - | - |
| euro/pc | | - | - | - | - | - | 5,07 | 5,92 | 5,50 | - |

| | | | | | | | | | | |
|-------------------|---|---|---|---|---|-------|---|---|---|-----|
| titanium anodised |  | - | - | - | - | 75299 | - | - | - | - |
| euro/m | | - | - | - | - | 7,15 | - | - | - | - |
| length cm | | | | | | | | | | 270 |

STAINLESS STEEL

| | | | | | | | | | | |
|---|---|---|---|---|---|---|---|---|---|-------|
| satin stainless steel AISI 304 DIN 1.4301 |  | - | - | - | - | - | - | - | - | 75275 |
| euro/m | | - | - | - | - | - | - | - | - | 17,16 |

art. 73/, 58/ and 74/ individually packed

PROTECT

| | | | | | | | |
|-----------|--------|----|---|--|----|--|--|
| pack | 30 pcs | | | 10 pcs / blister  | | | |
| length cm | 340 | | | 113 | | | |
| ART. | 87/ | | | 487/ | | | |
| finishing | F | SF | A | CV | AD | | |

ALUMINIUM

| | | | | | | | | |
|-----------------|---|-------|-------|-------|-------|-------|--|--|
| silver anodised |  | 75108 | 75109 | 75138 | 22615 | 22641 | | |
| euro/m | | 5,12 | 4,97 | 6,76 | - | - | | |
| euro/pc | | - | - | - | 7,12 | 8,70 | | |

| | | | | | | | |
|-----------|--------|----|---|-------|---|--|--|
| pack | 10 pcs | | | 5 pcs | | | |
| length cm | 270 | | | 270 | | | |
| ART. | 370/ | | | 373/ | | | |
| finishing | F | SF | A | F | A | | |

BRASS

| | | | | | | | | |
|----------|---|---|-------|-------|-------|-------|--|--|
| polished |  | - | 75169 | 75178 | 75188 | 75198 | | |
| euro/m | | - | 22,10 | 25,11 | 29,73 | 32,45 | | |

art. 87/ and 370/ individually packed

Prostep Flex is a line of bendable profiles for the protection of steps or platforms. These profiles can be curved through our Proflex Machine.



GF/710 silver anodised aluminium

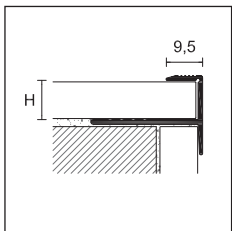

GF/

PRO FLEX LINE

PROSTEP FLEX

length = 270 cm - pack 10 pcs

| | | H | |
|------------------|-----------------|-------------|-------------|
| ART. | finishing | 10 | 15 |
| ALUMINIUM | | 710 | 715 |
| GF/ | silver anodised | 67569 | 67350 |
| | gold anodised | - | - |
| euro/m | | 7,13 | 7,54 |

individually packed

Protect 70, 71 and 130 are profiles for protection of step edge in wood, ceramic or marble already laid. They are in accordance with DIN51131 regulation concerning non-slip stair nosing. They are available in the version with holes and self-adhesive and they are particularly suitable for public environments in adaptation to standards.



71/SF silver anodised aluminium

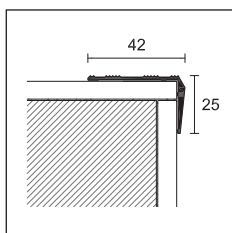

70/

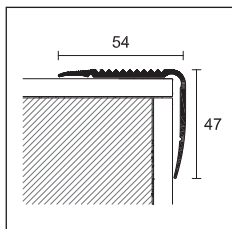

71/

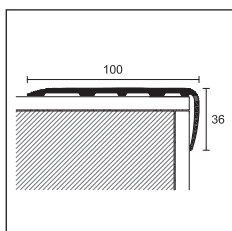

130/

PROTECT

| | | | |
|------------------|-------------|------------------|--------------|
| pack | 20 | 10 pcs / blister | |
| length cm | 340 | 113 | 166 |
| ART. | 70/ | 470/ | |
| finishing | F | SF | A |
| ALUMINIUM | | | |
| silver anodised | 75328 | 75329 | 75358 |
| gold anodised | 75338 | - | 75368 |
| euro/m | 8,30 | 8,12 | 10,08 |
| euro/pc | - | - | - |
| | | 11,01 | 15,87 |

art. 70/ individually packed

PROTECT

| | | | |
|------------------|--------------|--------------|--------------|
| pack | 10 pcs | 8 pcs | |
| length cm | 340 | 270 | |
| ART. | 71/ | 130/ | |
| finishing | F | SF | F |
| ALUMINIUM | | | |
| silver anodised | 64067 | 64066 | 75804 |
| euro/m | 14,51 | 13,89 | 24,76 |
| | | | 23,84 |

Complete the article code with F=drilled, A/AD=adhesive, SF=undrilled, CV=with screws (eg. 87/ drilled becomes 87/F) - packaging in blister no partial packaging - For a single piece, see sales conditions on page 288

stair nosing profiles

protect

Protect 76, 124, 110, 80 and 126 are anodised aluminium profiles with non-slip Safety-Step inserts or rubber for the protection of already-laid ceramic, wood or carpet steps. Compliant with DIN 51131 regulation regarding non-slip steps, they are available in drilled version and are particularly suitable for public spaces for the adaptation to standards.

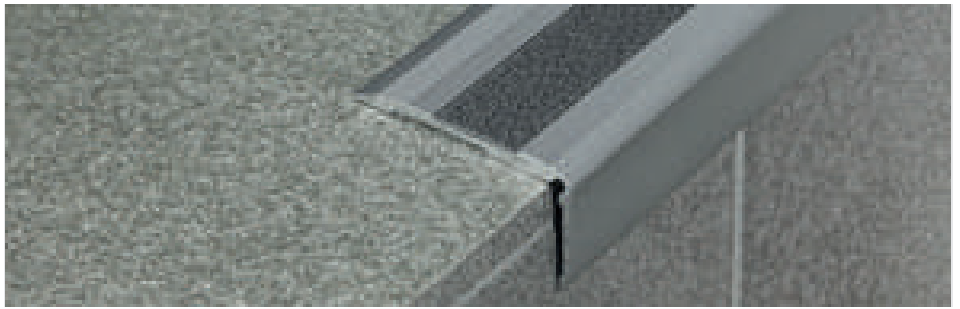

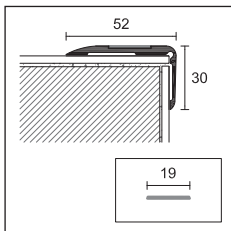

76/F silver anodised aluminium + black slip-resistant insert



76/

PROTECT

| | | | |
|------------------|---|---|-------|
| pack | 10 pcs | 5 pcs / blister  | |
| length cm | 340 | 113 | |
| ART. | 76/ | 476/ | |
| finishing | F | CV | AD |
| ALUMINIUM | | | |
| silver anodised |  75448 | 21680 | 21696 |
| euro/m | 12,10 | - | - |
| euro/pc | - | 17,75 | 19,74 |

SLIP-RESISTANT ROLL

| | | | |
|-----------------------------|---|-------|--|
| length = 1820 cm - width mm | 19 | | |
| 4 rolls pack - | | | |
| black |  | 23002 | |
| euro/m | | 1,84 | |

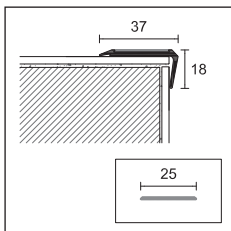

124/

PROTECT

| | | | |
|-------------------------------|---|-------|--|
| length = 270 cm - pack 24 pcs | | | |
| ART. | 124/ | | |
| finishing | F | | |
| ALUMINIUM | | | |
| silver anodised |  | 75794 | |
| euro/m | | 10,16 | |

SLIP-RESISTANT ROLL

| | | | |
|-----------------------------|---|-------|--|
| length = 1820 cm - width mm | 25 | | |
| 4 rolls pack - | | | |
| black |  | 23004 | |
| euro/m | | 2,43 | |

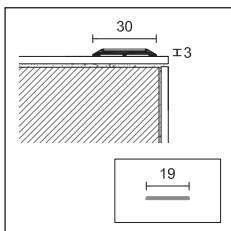

110/

PROTECT

| | | | |
|-------------------------------|---|-------|--|
| length = 270 cm - pack 24 pcs | | | |
| ART. | 110/ | | |
| finishing | F | | |
| ALUMINIUM | | | |
| silver anodised |  | 75780 | |
| euro/m | | 9,27 | |

SLIP-RESISTANT ROLL

| | | | |
|-----------------------------|---|-------|--|
| length = 1820 cm - width mm | 19 | | |
| 4 rolls pack - | | | |
| black |  | 23002 | |
| euro/m | | 1,84 | |

The price per meter of 76/, 124/ and 110/ does not include the non-slip insert that must be ordered separately.

Complete the article code with F=drilled, AD=adhesive, CV=screws (eg. 110/ drilled becomes 110/F)

 packaging in blister no partial packaging

For a single piece, see sales conditions on page 288



124/F silver anodised aluminium + black slip-resistant insert



110/F silver anodised aluminium + black slip-resistant insert

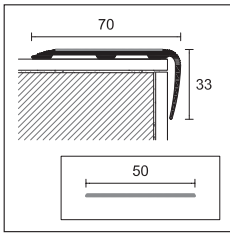

80/

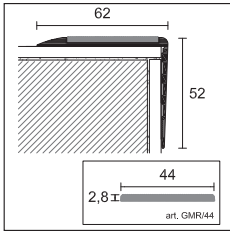

126/

PROTECT

length = 340 cm - pack 10 pcs

| | | |
|------------------|---|--------------|
| ART. | | 80/ |
| finishing | | F |
| ALUMINIUM | | |
| silver anodised |  | 64077 |
| euro/m | | 15,57 |

SLIP-RESISTANT ROLL

length = 1820 cm - width mm
2 rolls pack -

| | | |
|---------------|---|-------------|
| | | 50 |
| black |  | 23006 |
| euro/m | | 4,82 |

PROTECT

length = 270 cm - pack 6 pcs

| | | |
|------------------|---|--------------|
| ART. | | 126/ |
| finishing | | F |
| ALUMINIUM | | |
| silver anodised |  | 75798 |
| euro/m | | 15,10 |

GROOVED RUBBER

length = 1700 cm - 1 rolls pack

| | | |
|---------------|---|---------------|
| ART. | | GMR/44 |
| black |  | 75706 |
| euro/m | | 6,30 |



80/F silver anodised aluminium

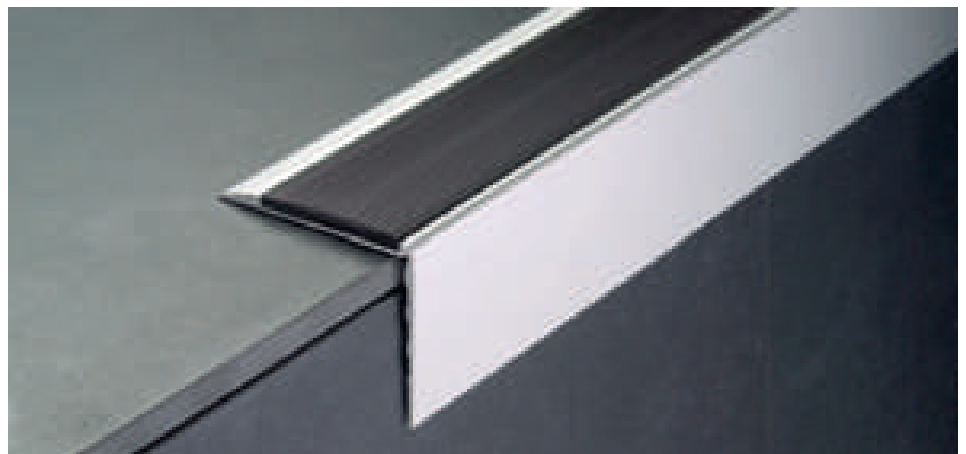

126/F silver anodised aluminium

The price per meter of 80/ does not include the non-slip insert that must be ordered separately.

The price per meter of 126/ does not include the grooved rubber that must be ordered separately.

Complete the article code with F=drilled (for example 80/ drilled becomes 80/F)

For a single piece, see sales conditions on page 288

stair nosing profiles

protect

Protect 72, 79, 125 and 78 are anodised aluminium profiles with rubber insert replaceable for the protection fo step edge in ceramic, wood, marble and carpet already laid. They are in accordance with DIN 51131 regulation of non-slip stair nosing. They are available in the version with holes and they are particularly suitable for public environments in adaptation to standards.



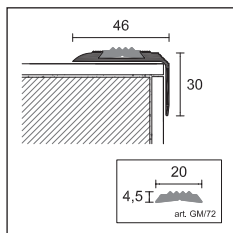

72/F silver anodised aluminium + GM/72 black



72/

PROTECT

length = 340 cm - pack 10 pcs

| | | |
|------------------|---|--------------|
| ART. | | 72/ |
| finishing | | F |
| ALUMINIUM | | |
| silver anodised |  | 75508 |
| gold anodised |  | 75518 |
| euro/m | | 10,30 |

GROOVED RUBBER

length = 3400 cm - 2 rolls pack

| | | |
|---------------|---|--------------|
| ART. | | GM/72 |
| black |  | 75565 |
| euro/m | | 1,91 |

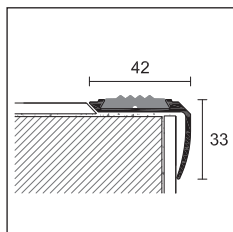

79/F + GM/R

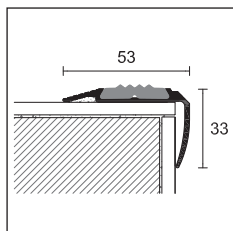

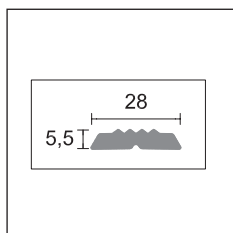

125/F + GM/R



GM/R

PROTECT

| | | |
|------------------|---|--------------|
| pack | 10 | 10 |
| length cm | 340 | 270 |
| ART. | 79/ | 125/ |
| finishing | F | F |
| ALUMINIUM | | |
| silver anodised |  | 75728 |
| bronze anodised |  | - |
| euro/m | 8,28 | 12,55 |

GROOVED RUBBER

length = 3400 cm - 2 rolls pack

| | | |
|---------------|---|-------------|
| ART. | | GM/R |
| black |  | 75705 |
| euro/m | | 2,40 |

The price per meter of 72/, 79/ and 125/ does not include the grooved rubber that must be ordered separately.

Complete the article code with F=drilled (for example 72/ drilled becomes 72/F)

For a single piece, see sales conditions on page 288

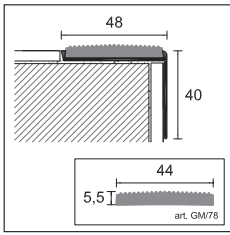

78/

PROTECT

length = 340 cm - pack 20 pcs

ART. **78/**

finishing **F**

ALUMINIUM

silver anodised  75578

euro/m **9,83**

GROOVED RUBBER

length = 1700 cm - 2 rolls pack

ART. **GM/78**

black  75635

euro/m **4,58**



125/F silver anodised aluminium + GM/R black



78/F silver anodised aluminium

The price per meter of 78/ does not include the grooved rubber that must be ordered separately.

Complete the article code with F=drilled (for example 78/ drilled becomes 78/F)

For a single piece, see sales conditions on page 288

stair nosing profiles

protect

Protect 150, 151, 152, 154, 155 and 156 are PVC profiles for the protection of the step edge in ceramic, marble, wood, PVC, linoleum, carpet or LVT to be laid or already laid.



150 Black PVC

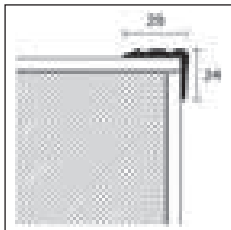

150

PROTECT

length = 300 cm - pack 15 pcs

ART. finishing

PVC

| | | | |
|-----|---------------|---|-------------|
| | black |  | 19100 |
| 150 | grey |  | 19101 |
| | brown |  | 19102 |
| | euro/m | | 2,58 |

no partial packaging

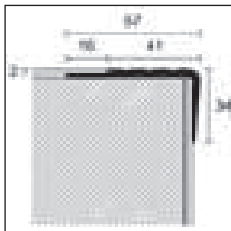

151

PROTECT

length = 300 cm - pack 15 pcs

ART. finishing

PVC

| | | | |
|-----|---------------|---|-------------|
| | black |  | 19110 |
| 151 | grey |  | 19111 |
| | brown |  | 19112 |
| | euro/m | | 3,90 |

no partial packaging

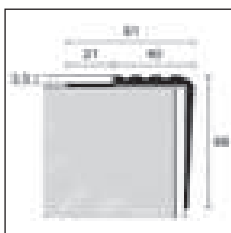

152

PROTECT

length = 300 cm - pack 15 pcs

ART. finishing

PVC

| | | | |
|-----|---------------|---|-------------|
| | black |  | 19120 |
| 152 | grey |  | 19121 |
| | brown |  | - |
| | euro/m | | 5,24 |

no partial packaging



151 Black PVC



152 Grey PVC

All articles Protect in PVC should be stored horizontally

For a single piece, see sales conditions on page 288

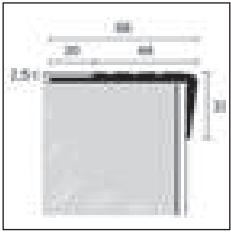

154

PROTECT

length = 300 cm - pack 15 pcs

ART. finishing

PVC

| | | | |
|------------|---------------|---|-------------|
| | black |  | 19140 |
| 154 | grey |  | 19141 |
| | brown |  | - |
| | euro/m | | 4,78 |

no partial packaging

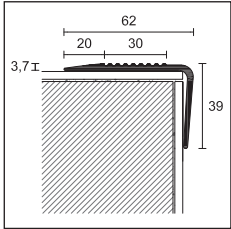

155

PROTECT

length = 300 cm - pack 15 pcs

ART. finishing

PVC

| | | | |
|------------|---------------|---|-------------|
| | black |  | 19150 |
| 155 | grey |  | 19151 |
| | brown |  | 19152 |
| | euro/m | | 4,49 |

no partial packaging

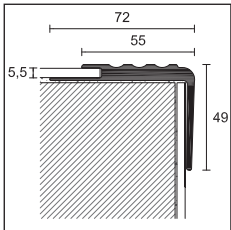

156

PROTECT

length = 300 cm - pack 10 pcs

ART. finishing

PVC

| | | | |
|------------|---------------|---|-------------|
| | black |  | 19160 |
| 156 | grey |  | 19161 |
| | brown |  | 19162 |
| | euro/m | | 7,96 |

no partial packaging



154 Brown PVC



155 Black PVC



156 Grey PVC

All articles Protect in PVC should be stored horizontally

For a single piece, see sales conditions on page 288



safety-step

Slip -resistant strips Safety-Step: it is a line of anti-slip adhesive coverings consisting of abrasive particles aggregated by synthetic resins on dimensionally stable support. Suitable for all surfaces subjected to heavy traffic, both pedestrian and vehicular, such as stairs, hall of office and apartment buildings, ramps, walkways, elevators, platforms machinery, emergency exits etc..



Safety-Step - slip-resistant strip

SAFETY-STEP - SLIP-RESISTANT STRIP

| colour | width (mm) | length (cm) | code | euro/pc | pack |
|-------------|------------|-------------|-------|---------|---|
| black | 19 | 61 | 23000 | 1,73 | 50 |
| black | 25 | 61 | 23001 | 2,05 | 50 |
| black | 19 | 61 | 23100 | 9,03 | 10 pcs/ blister  |
| black | 25 | 61 | 23101 | 10,29 | 10 pcs/ blister  |
| transparent | 19 | 61 | 23016 | 1,73 | 50 |

no partial packaging - one blister contains 4 strips

ADHESIVE FOR BORDERS

ml 140 - pack 12 pcs

output: 1 cartridge every 35 meters

ART.

H3502

23181

euro/pc

40,27

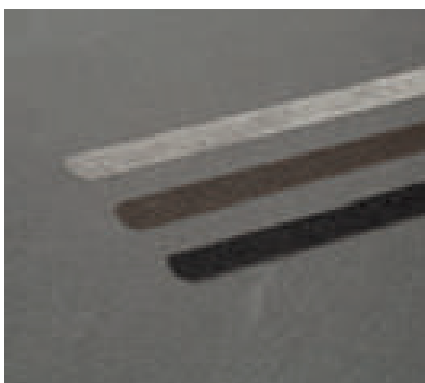

Safety-Step - slip-resistant strip



Safety-Step - slip-resistant roll

 packaging in blister no partial packaging

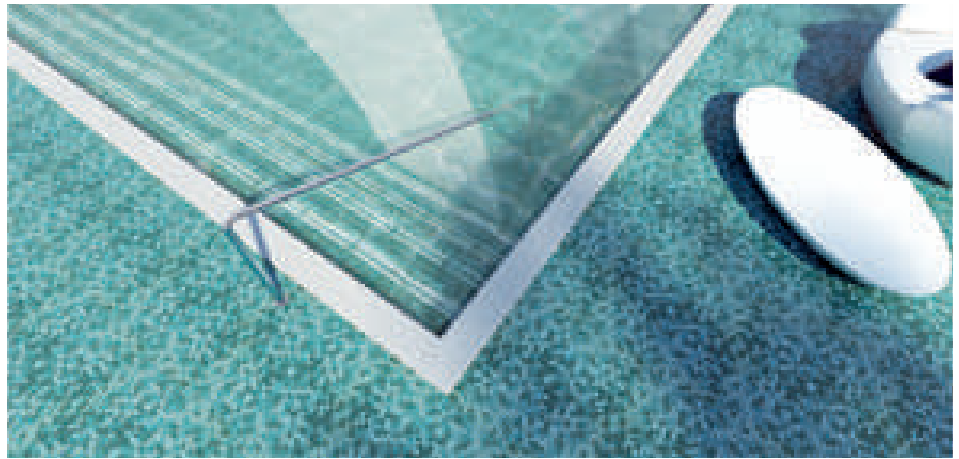

For a single piece, see sales conditions on page 288

Slip-resistant rolls Safety-Step: it is a line of anti-slip adhesive coverings consisting of abrasive particles aggregated by synthetic resins on dimensionally stable support. Suitable for all surfaces subjected to heavy traffic, both pedestrian and vehicular, such as stairs, hall of office and apartment buildings, ramps, walkways, elevators, platforms machinery, emergency exits etc.. The grey versions (Resilient Medium / Fine) consist of a rubber surface, and are perfect for areas of the walkway also barefoot such as showers, locker rooms, saunas, boats, sports equipment and etc...



Safety-Step - slip-resistant roll

SAFETY-STEP - SLIP-RESISTANT ROLL

| colour | width (mm) | length (cm) | code | euro/pc | pack |
|-------------|------------|-------------|-------|---------|--|
| black | 19 | 1820 | 23002 | 22,58 | 4 |
| black | 25 | 1820 | 23004 | 29,82 | 4 |
| black | 50 | 1820 | 23006 | 59,64 | 2 |
| black | 19 | 360 | 23103 | 6,62 | 10 pcs/blister  |
| black | 25 | 360 | 23105 | 8,09 | 10 pcs/blister  |
| transparent | 19 | 1820 | 23018 | 27,09 | 4 |
| transparent | 25 | 1820 | 23020 | 35,81 | 4 |
| transparent | 50 | 1820 | 23022 | 71,61 | 2 |
| grey | 25 | 1820 | 23044 | 91,46 | 4 |
| grey | 50 | 1820 | 23046 | 182,91 | 2 |

 packaging in blister no partial packaging

For a single piece, see sales conditions on page 288



slip-resistant strip Safety-Step

prostair

Prostair is a system composed of a profile and its relative accessories for the anchorage of stair rods on steps. The fixing accessories permit a quick removal of the stair rods for cleaning or replacement.

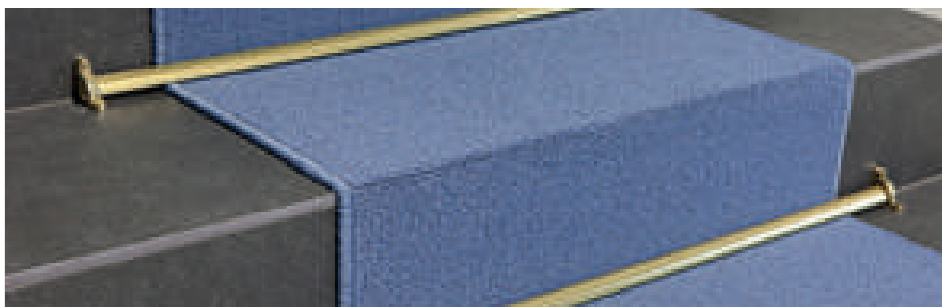

155/16 bright polished gold aluminium + 177/16

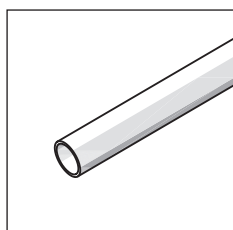

151/11

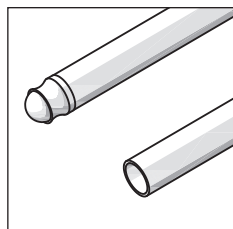

150/

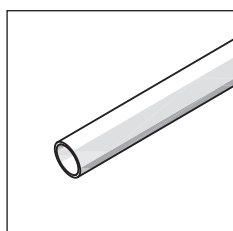

163/

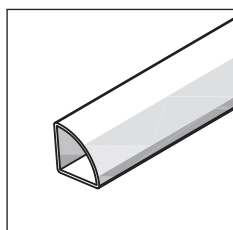

155/16

art. 163/ available in different lengths on request, extra €/pc 1,29

Complete the article code with the diameter measure (for example 150/ for diameter=11 becomes 150/11)

For a single piece, see sales conditions on page 288

PROSTAIR

length = 380 cm - diameter 11 - pack 20 pcs

ART. finishing

ALUMINIUM

| | | | |
|---------------|------------------------|--|-------------|
| 151/11 | bright polished silver | | 78430 |
| | <i>euro/m</i> | | 6,56 |

PROSTAIR

pack 20 pcs

length cm 80 90 100 120 380

ART. finishing

ALUMINIUM

| | | diameter | | | | | |
|-------------|----------------------|-------------|-------------|--------------|--------------|-------------|----|
| | | 11 | 11 | 13 | 13 | 16 | 16 |
| | | 78311 | 78312 | 78313 | 78314 | 78319 | |
| | <i>euro/pc</i> | 8,80 | 9,47 | 10,12 | 11,42 | - | |
| | <i>euro/m</i> | - | - | - | - | 6,56 | |
| 150/ | bright polished gold | 78321 | - | 78323 | - | 78329 | |
| | <i>euro/pc</i> | 9,50 | - | 10,87 | - | - | |
| | <i>euro/m</i> | - | - | - | - | 6,80 | |
| | | - | - | - | - | 78339 | |
| | <i>euro/m</i> | - | - | - | - | 7,61 | |

pack 10 pcs / blister

| | | | | | | | | |
|------------------|----------------------|--|----|--------------|--------------|--------------|---|---|
| 4150/11/S | bright polished gold | | 11 | 21810 | 21811 | 21812 | - | - |
| | <i>euro/blister</i> | | | 19,02 | 20,33 | 21,62 | - | - |

articles 150/11, 150/13 and 150/16 of 380 cm partial packaging available and without knobs, for other articles no partial packaging - article 150/13 of 380 cm pack 40 pcs - article 150/16 of 380 cm pack 25 pcs

PROSTAIR

pack 10 pcs 10 pcs 10 pcs

length = 380 cm

finishing

BRASS

| | | diameter | | | |
|-------------|---------------|----------|--------------|--------------|--------------|
| | | 11 | 13 | 16 | |
| 163/ | polished | | 78801 | 78802 | 78803 |
| | <i>euro/m</i> | | 15,57 | 17,77 | 19,56 |

OTHER PROFILES

length = 300 cm - pack 20 pcs

ART. finishing

16x16

ALUMINIUM

| | | | |
|---------------|----------------------|--|--------------|
| 155/16 | bright polished gold | | 78379 |
| | <i>euro/m</i> | | 10,72 |

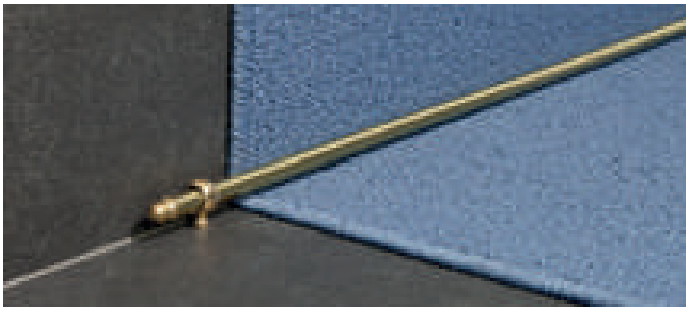

163/13 polished brass + 170/13



155/16 bright polished gold aluminium + 168/16 + 178/16

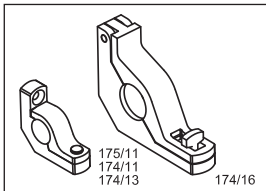

175/11 + 174/

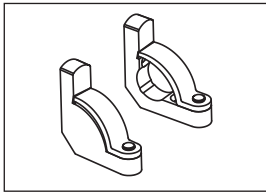

177/16

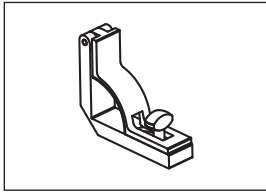

178/16

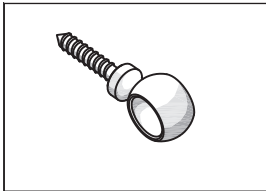

171/ + 170/

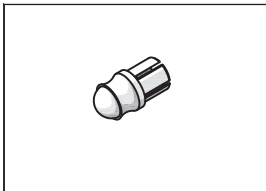

161/11 + 169/

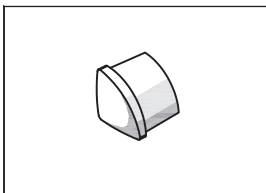

168/16

Complete the article code with diameter measure (eg. 174/ for diameter=11 becomes 174/11)

For a single piece, see sales conditions on page 288

ACCESSORIES - BRACKETS

| pack 20 pcs | | diameter | | |
|-----------------------------|--------------------|----------|----|-------|
| ART. | finishing | 11 | 13 | 16 |
| BRASS | | | | |
| 175/11 | chromium plated | 78445 | - | - |
| | <i>euro/pc</i> | 11,64 | - | - |
| pack 20 pcs | | | | |
| 174/ | polished | 78410 | - | 78412 |
| | <i>euro/pc</i> | 8,04 | - | 11,78 |
| pack 10 couples 2 pcs dx/sx | | | | |
| 177/16 | polished | - | - | 78415 |
| | <i>euro/couple</i> | - | - | 27,45 |
| pack 20 pcs | | measures | | |
| | | 16x16 | | |
| 178/16 | polished | 78420 | | |
| | <i>euro/pc</i> | 9,28 | | |

ACCESSORIES - RINGS

| pack 20 pcs | | diameter | | |
|---------------------------------|---------------------|----------|-------|-------|
| ART. | finishing | 11 | 13 | 16 |
| BRASS | | | | |
| 171/11 | chromium plated | 78440 | - | - |
| | <i>euro/pc</i> | 4,27 | - | - |
| pack 20 pcs | | | | |
| 170/ | polished | 78400 | 78401 | 78402 |
| | <i>euro/pc</i> | 2,50 | 2,75 | 4,29 |
| 10 blister packs/ 4 pcs/blister | | | | |
| 4170/ JS | polished | 21852 | - | - |
| | <i>euro/blister</i> | 10,82 | - | - |
| no partial packaging | | | | |

ACCESSORIES - KNOBS

| pack 20 pcs | | diameter | | |
|----------------------|--|----------|-------|-------|
| ART. | finishing | 11 | 13 | 16 |
| BRASS | | | | |
| 161/11 | chromium plated | 78435 | - | - |
| | <i>euro/pc</i> | 2,64 | - | - |
| pack 20 pcs | | | | |
| 169/ | brass (for aluminium and brass profiles) | 78395 | 78396 | 78397 |
| | <i>euro/pc</i> | 1,94 | 2,22 | 2,64 |
| pack 20 pcs | | 16x16 | | |
| 168/16 | polished | 78418 | | |
| | <i>euro/pc</i> | 3,33 | | |
| no partial packaging | | | | |





profiles for wooden, laminated and LVT floors

A full range of profiles for wooden, laminated and LVT floors. A series of systems and professional solutions proposed in different colours of anodised aluminium and in the exclusive finishes Alcrom® Plus, with the possibility of further customization thanks to PDS technology.

profiles for wooden and laminate floors

unisystem plus



Unisystem Plus is a system for the floating installation of wooden and laminate floors from 6,5 to 22,6 mm thickness. Composed of connection profiles for same and different level floors, perimetral profiles and stair nosing profiles, Unisystem Plus is easy to lay and simple to remove. The system is composed of a top profile, an aluminium base and a fixing clip: after inserting the fixing clip in the top profile, just push the top profile to fix it to the aluminium base.

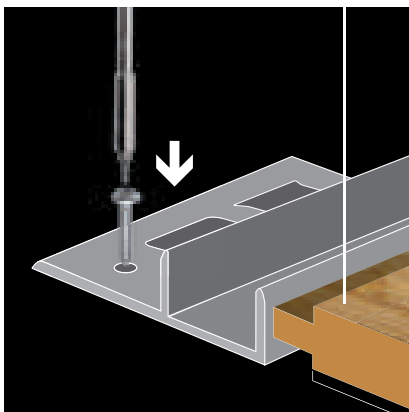

fix the aluminium base to the subfloor with screws or glue

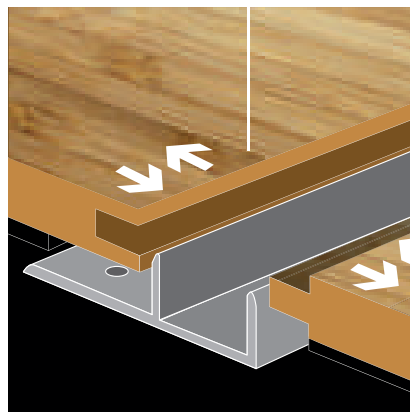

bring the floor planks closer

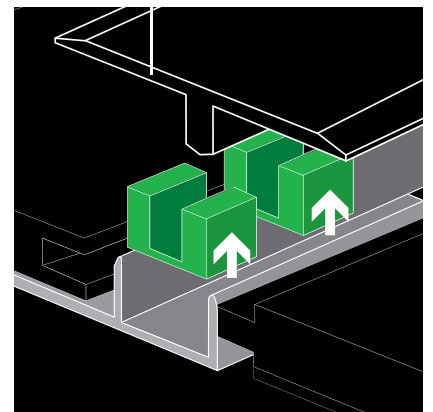

insert the clips in the top profile

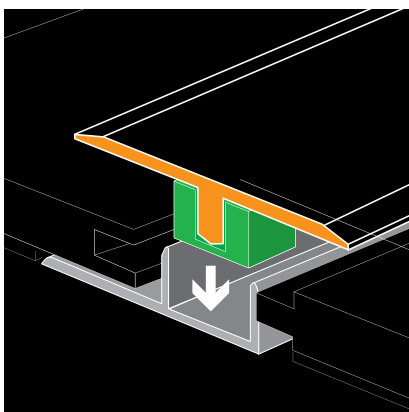

put the top profile in the base

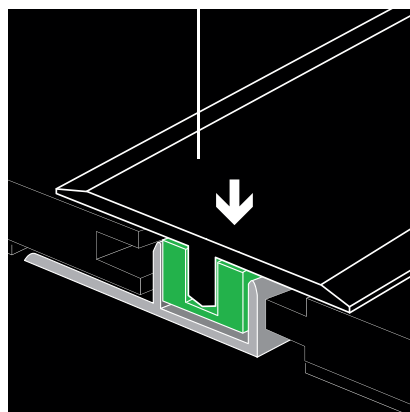

push the top profile in the base

Unisystem Plus line

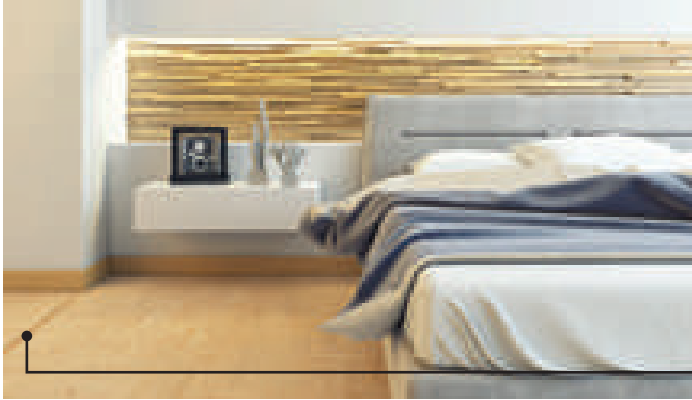

Connection profiles for floors of same level



Connection profiles for floors of different level



Perimetral profiles

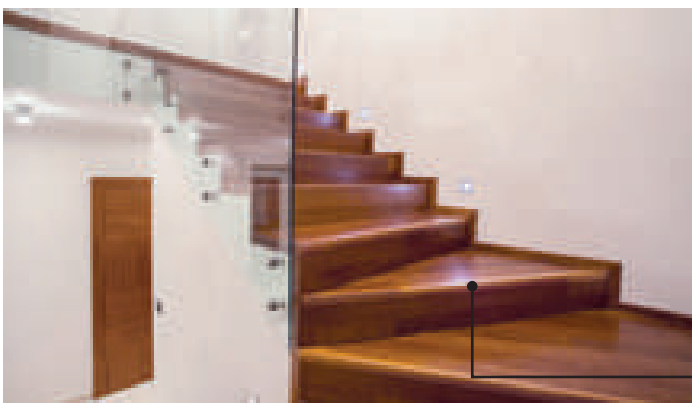

Stair nosing profiles



unisystem - unisystem plus

Unisystem Plus is a system for the floating installation of wooden and laminate floors from 6,5 to 22,6 mm thickness, composed of junction profiles for same level floors (Z/ series), connection profiles for different level floors (C/ series) and perimetral profiles (S/ series). The system is composed of a natural aluminium base and a top profile to be fixed on the base through a specific clip. The top profile is available in different finishes of anodised aluminium or covered with wood-effect Alcrom® Plus film for matching the floor perfectly.

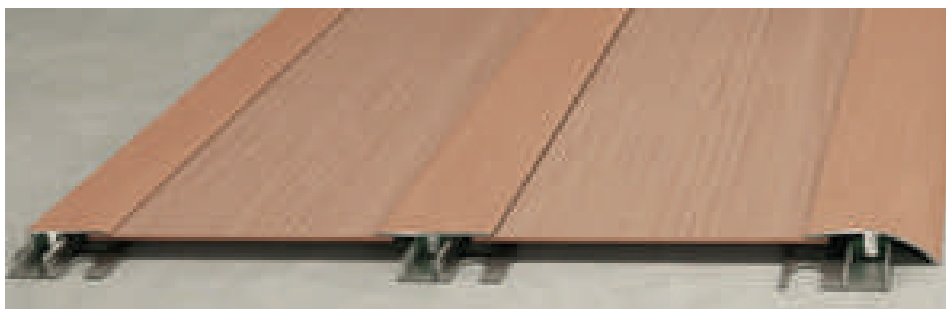

Unisystem Plus Z/1/SF, C/7/SF e S/9/SF

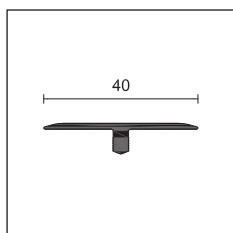

Z/1/SF

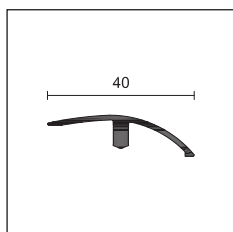

C/7/SF

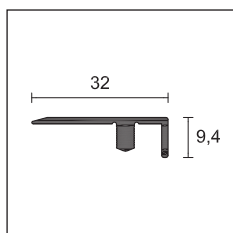

S/9/SF

UNISYSTEM/ UNISYSTEM PLUS

length = 270 cm - pack 10 pcs

| ART. | finishing | Z/1/SF | C/7/SF | S/9/SF |
|---|-----------|----------|--------|----------|
| floor thickness from / to mm | | 6,5/22,6 | 6,5/10 | 6,5/22,6 |
| ALUMINIUM covered with ALCROM® PLUS film | | | | |
| 02 | | 66301 | 66001 | 65701 |
| 05 | | 66306 | 66006 | 65706 |
| 08 | | 66304 | 66004 | 65704 |
| 10 | | 66307 | 66007 | 65707 |
| 11 | | 66308 | 66008 | 65708 |
| 12 | | 66309 | 66009 | 65709 |
| 13 | | 66310 | 66010 | 65710 |
| 14 | | 66311 | 66011 | 65711 |
| 18 | | 66316 | 66016 | 65716 |
| 19 | | 66318 | 66018 | 65718 |
| 20 | | 66317 | 66017 | 65717 |
| 26 | | 66321 | 66021 | 65721 |
| 31 | | 66328 | 66028 | 65728 |
| 32 | | 66329 | 66029 | 65729 |
| 34 | | 66331 | 66031 | 65731 |
| 35 | | 66332 | 66032 | 65732 |
| 36 | | 66333 | 66033 | 65733 |
| 37 | | 66334 | 66034 | 65734 |
| 38 | | 66335 | 66035 | 65735 |
| 39 | | 66336 | 66036 | 65736 |
| 40 | | 66337 | 66037 | 65737 |
| 41 | | 66338 | 66038 | 65738 |
| 42 | | 66339 | 66039 | 65739 |
| 43 | | 66340 | 66040 | 65740 |
| 44 | | 66341 | 66041 | 65741 |
| 47 | | 66344 | 66044 | 65744 |
| 65 | | 66365 | 66065 | 65765 |
| 71 | | 66368 | 66068 | 65768 |
| 72 | | 66369 | 66069 | 65769 |
| 73 | | 66370 | 66070 | 65770 |
| 74 | | 66371 | 66071 | 65771 |
| 76 | | 66374 | 66074 | 65774 |
| 77 | | 66372 | 66072 | 65772 |
| 78 | | 66376 | 66076 | 65776 |
| 79 | | 66373 | 66073 | 65773 |
| 80 | | 66377 | 66077 | 65777 |
| 81 | | 66378 | 66078 | 65778 |
| 89 | | 66386 | 66086 | 65784 |

euro/m

11,43

individually packed

UNISYSTEM/ UNISYSTEM PLUS

length = 270 cm - pack 10 pcs

| ART. | finishing | Z/1/SF | C/7/SF | S/9/SF |
|---|-----------|----------|--------|----------|
| floor thickness from / to mm | | 6,5/22,6 | 6,5/10 | 6,5/22,6 |
| ALUMINIUM covered with ALCROM® PLUS film | | | | |
| 91 | | 66388 | 66088 | 65786 |
| 92 | | 66389 | 66089 | 65789 |
| 93 | | 66390 | 66090 | 65790 |
| 94 | | 66391 | 66091 | 65791 |
| 95 | | 66392 | 66092 | 65792 |
| 351 | | 66393 | 66093 | - |
| 363 | | 66394 | 66094 | - |
| 372 | | 66395 | 66095 | - |
| 490 | | 66397 | 66097 | - |
| 560 | | 66398 | 66098 | - |
| 580 | | 66399 | 66099 | 65793 |
| 590 | | 66400 | 66100 | - |
| 665 | | 66401 | 66101 | 65794 |
| 670 | | 66402 | 66102 | 65795 |
| 951 | | 66408 | 66108 | 65797 |
| 975 | | 66409 | 66109 | 65798 |
| 1024 | | 66410 | 66110 | 65799 |
| 1033 | | 66411 | 66111 | 65800 |
| 1042 | | 66412 | 66112 | 65801 |
| 1090 | | 66414 | 66114 | 65803 |
| 1202 | | 66416 | 66116 | 65805 |
| 1203 | | 66417 | 66117 | 65806 |
| 1204 | | 66418 | 66118 | 65807 |
| 1205 | | 66419 | 66119 | 65808 |
| 1206 | | 66420 | 66120 | 65809 |
| 1207 | | 66421 | 66121 | 65810 |
| 1208 | | 66422 | 66122 | 65811 |
| 1209 | | 66423 | 66123 | 65812 |
| 1210 | | 66424 | 66124 | 65813 |
| 1211 | | 66425 | 66125 | 65814 |
| 1212 | | 66426 | 66126 | 65815 |
| 1213 | | 66427 | 66127 | 65816 |
| 1214 | | 66428 | 66128 | 65817 |
| 1215 | | 66429 | 66129 | 65818 |
| 1216 | | 66430 | 66130 | 65819 |
| 1217 | | 66431 | 66131 | 65820 |
| 100 | | 66432 | 66132 | - |
| NEW | black 97 | 66433 | 66133 | 65821 |

euro/m

11,43

individually packed





For a single piece, see sales conditions on page 288

Profiles of 270 cm length: please order the base separately.

Customized PDS decors on request, see page 195

UNISYSTEM/ UNISYSTEM PLUS

length = 270 cm - pack 20 pcs

| ART. | finishing | Z/1/SF | C/7/SF | S/9/SF |
|------------------------------|---|-------------|-------------|-------------|
| floor thickness from / to mm | | 6,5/22,6 | 6,5/10 | 6,5/22,6 |
| ANODISED ALUMINIUM | | | | |
| silver |  | 67217 | 67007 | 65680 |
| gold |  | 67227 | 67017 | 65685 |
| gold sand |  | 67234 | 67024 | 65688 |
| bronze |  | 67237 | 67027 | 65690 |
| <i>euro/m</i> | | 6,86 | 6,86 | 6,86 |
| titanium |  | 67238 | 67000 | 65691 |
| <i>euro/m</i> | | 7,49 | 7,49 | 7,49 |

Other models for thicker floors available on page 176 individually packed

UNISYSTEM PLUS - BASES

| | | | | | | | |
|---|-------------------|---|-------------|-------------|-------------|-------------|-------------|
| floor thickness from / to mm | | 6,5/10 | 9,6/12,5 | 12,6/15,5 | 15/19 | 19,6/22,6 | |
| length = 270 cm pack 20 pcs (15 clips TU/6 included) | | H | | | | | |
| ART. | finishing | 6 | 10 | 13 | 15 | 22 | |
| ALUMINIUM | | | | | | | |
| TPU/ | natural aluminium |  | 67437 | 67447 | 67457 | 67460 | 67467 |
| | <i>euro/m</i> | | 4,71 | 5,26 | 5,74 | 6,41 | 8,37 |

individually packed (art. TPU/22 pack 10 pcs)

SPARE CLIPS

pack of 150 pcs

| | | | | | | |
|------------------|--|--------------|--|--|--|--|
| | | H | | | | |
| | | 6 | | | | |
| TU/6 | | 68812/150 | | | | |
| <i>euro/pack</i> | | 22,42 | | | | |

no partial packaging

UNISYSTEM - BASES

| | | | | | | | |
|-------------------------------|-------------------|---|-------------|-------------|-------------|-------------|-------------|
| floor thickness from / to mm | | 6,5/10 | 10,12 | 6,5/10 | 13/15 | 11/15 | |
| length = 270 cm - pack 20 pcs | | H | | | | | |
| ART. | finishing | 7 | 10 | 11 | 13 | 15 | |
| ALUMINIUM | | | | | | | |
| T/ | natural aluminium |  | 67287 | 67297 | 67317 | 67307 | 67327 |
| | <i>euro/m</i> | | 4,71 | 5,26 | 4,67 | 5,74 | 5,30 |

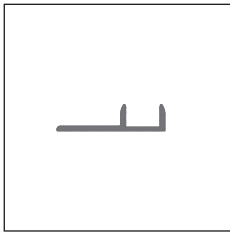

TPU/

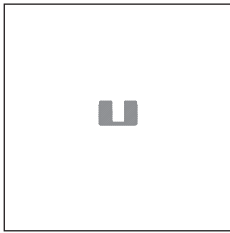

TU/6

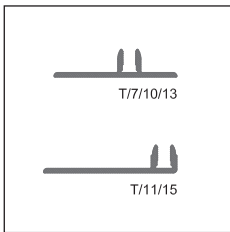

T/

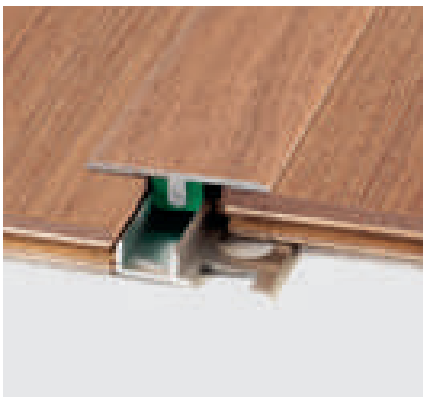

Z/1/SF aluminium covered with Alcrom® Plus film



C/7/SF aluminium covered with Alcrom® Plus film



S/9/SF aluminium covered with Alcrom® Plus film

unisystem - unisystem plus

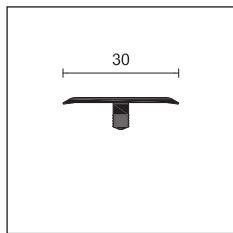

Z3/30/SF

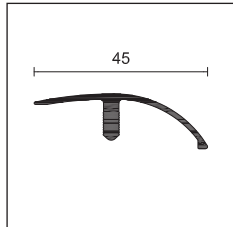

C/10/SF

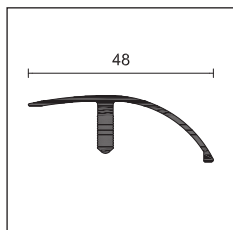

C/13/SF

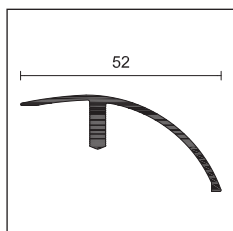

C/22/SF

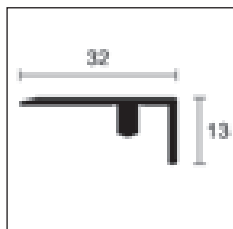

S/15/SF

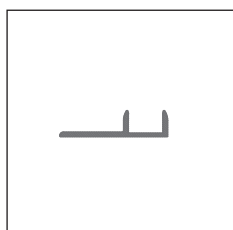

TPU/

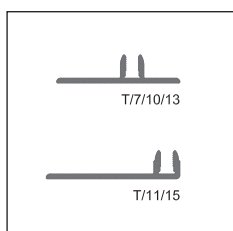

T/

UNISYSTEM - UNISYSTEM PLUS

| length = 270 cm | | pack 20 pcs | pack 20 pcs | pack 10 pcs | pack 10 pcs | pack 10 pcs |
|------------------------------|------------------|-----------------|----------------|----------------|----------------|----------------|
| ART. | finishing | Z3/30/SF | C/10/SF | C/13/SF | C/22/SF | S/15/SF |
| floor thickness from / to mm | | 6,5/22,6 | 9,6/12,5 | 12,6/15,5 | 15/22,6 | 9,6/22,6 |
| ANODISED ALUMINIUM | | | | | | |
| silver | | 63700 | 67077 | 67147 | 66907 | 65480 |
| gold | | 63702 | 67087 | 67157 | - | - |
| gold sand | | 63704 | - | - | - | 65488 |
| euro/m | | 6,42 | 7,76 | 9,04 | 14,83 | 7,18 |
| individually packed | | | | | | |

UNISYSTEM PLUS - BASES

| floor thickness from / to mm | | 6,5/10 | 9,6/12,5 | 12,6/15,5 | 15/19 | 19,6/22,6 |
|---|-------------------|-------------|-------------|-------------|-------------|-------------|
| length = 270 cm pack 20 pcs (15 clips TU/6 included) | | H | | | | |
| ART. | finishing | 6 | 10 | 13 | 15 | 22 |
| ALUMINIUM | | | | | | |
| TPU/ | natural aluminium | | 67437 | 67447 | 67457 | 67460 |
| | euro/m | 4,71 | 5,26 | 5,74 | 6,41 | 8,37 |
| individually packed (art. TPU/22 pack 10 pcs) | | | | | | |

SPARE CLIPS

| pack da 150 pcs | | H |
|----------------------|--|--------------|
| | | 6 |
| TU/6 | | 68812/150 |
| euro/pack | | 22,42 |
| no partial packaging | | |

UNISYSTEM - BASES

| floor thickness from / to mm | | 6,5/10 | 10/12 | 6,5/10 | 13/15 | 11/15 |
|-------------------------------|-------------------|-------------|-------------|-------------|-------------|-------------|
| length = 270 cm - pack 20 pcs | | H | | | | |
| ART. | finishing | 7 | 10 | 11 | 13 | 15 |
| ALUMINIUM | | | | | | |
| T/ | natural aluminium | | 67287 | 67297 | 67317 | 67307 |
| | euro/m | 4,71 | 5,26 | 4,67 | 5,74 | 5,30 |



Z3/30/SF silver anodised aluminium

Customized PDS decors on request, see page 195

For a single piece, see sales conditions on page 288

unisystem - unisystem plus

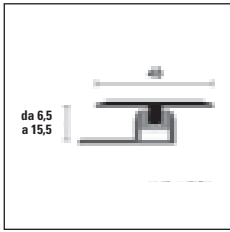

TPZ/

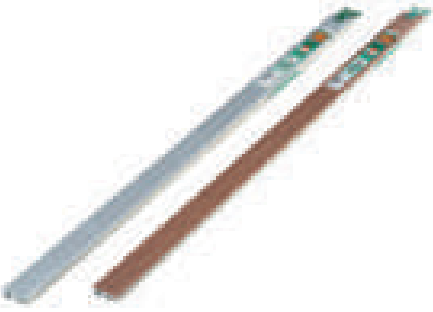

TPZ/47/CV silver anodised aluminium and aluminium covered with Alcrom® Plus film

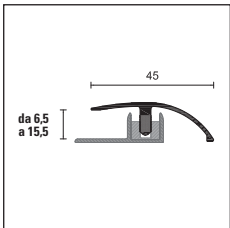

TPC/

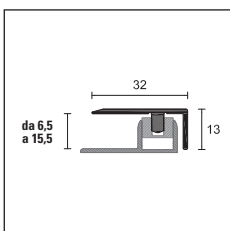

TPS/

The blister pack contains base, clips and profile.

UNISYSTEM PLUS

length = 90 cm - pack 10 pcs / blister - for floor thicknesses from 6,5 to 10 mm

ART. finishing

ALUMINIUM covered with ALCROM® PLUS film

| | | | | | | | | |
|------------------|----|-------|--|------|-------|--|------|--------------|
| | 05 | 43005 | | 77 | 43011 | | 1208 | 43027 |
| | 10 | 43020 | | 78 | 43066 | | 1209 | 43029 |
| | 14 | 43006 | | 80 | 43068 | | 1210 | 43030 |
| | 19 | 43007 | | 89 | 43012 | | 1211 | 43031 |
| | 20 | 43028 | | 91 | 43013 | | 1212 | 43033 |
| TPZ/47/CV | 26 | 43008 | | 580 | 43014 | | 1213 | 43035 |
| | 31 | 43009 | | 1202 | 43016 | | 1214 | 43037 |
| | 38 | 43034 | | 1203 | 43017 | | 1215 | 43039 |
| | 39 | 43010 | | 1204 | 43018 | | 1216 | 43041 |
| | 40 | 43036 | | 1205 | 43019 | | 1217 | 43043 |
| | 42 | 43038 | | 1206 | 43025 | | | |
| | 65 | 43056 | | 1207 | 43026 | | | |
| euro/pc | | | | | | | | 15,96 |

individually packed

UNISYSTEM PLUS

length = 90 cm - pack 10 pcs / blister

ART. finishing

| | | TPZ/47/CV | TPZ/410/CV | TPZ/413/CV |
|------------------------------|--|------------------|-------------------|-------------------|
| floor thickness from / to mm | | 6,5 / 10 | 9,6 / 12,5 | 12,6 / 15,5 |
| ANODISED ALUMINIUM | | | | |
| silver | | 43000 | 43072 | 43144 |
| gold | | 43004 | 43076 | 43148 |
| euro/pc | | 11,85 | 12,36 | 12,81 |

individually packed

UNISYSTEM PLUS

length = 90 cm - pack 10 pcs / blister - for floor thicknesses from 6,5 to 10 mm

ART. finishing

ALUMINIUM covered with ALCROM® PLUS film

| | | | | | | | | |
|------------------|----|-------|--|------|-------|--|------|--------------|
| | 05 | 43219 | | 77 | 43225 | | 1208 | 43239 |
| | 10 | 43234 | | 78 | 43280 | | 1209 | 43240 |
| | 14 | 43220 | | 80 | 43282 | | 1210 | 43241 |
| | 19 | 43221 | | 89 | 43226 | | 1211 | 43243 |
| | 20 | 43242 | | 91 | 43227 | | 1212 | 43244 |
| TPC/47/CV | 26 | 43222 | | 580 | 43228 | | 1213 | 43245 |
| | 31 | 43223 | | 1202 | 43231 | | 1214 | 43247 |
| | 38 | 43248 | | 1203 | 43232 | | 1215 | 43249 |
| | 39 | 43224 | | 1204 | 43233 | | 1216 | 43251 |
| | 40 | 43250 | | 1205 | 43235 | | 1217 | 43253 |
| | 42 | 43252 | | 1206 | 43236 | | | |
| | 65 | 43270 | | 1207 | 43237 | | | |
| euro/pc | | | | | | | | 15,96 |

individually packed

UNISYSTEM PLUS

length = 90 cm - pack 10 pcs / blister

ART. finishing

| | | TPC/47/CV | TPC/410/CV | TPC/413/CV |
|------------------------------|--|------------------|-------------------|-------------------|
| floor thickness from / to mm | | 6,5 / 10 | 9,6 / 12,5 | 12,6 / 15,5 |
| ANODISED ALUMINIUM | | | | |
| silver | | 43214 | 43286 | 43358 |
| gold | | 43218 | 43290 | 43362 |
| euro/pc | | 11,85 | 12,59 | 13,83 |

individually packed

UNISYSTEM PLUS

length = 90 cm - pack 10 pcs / blister

ART. finishing

| | | TPS/47/CV | TPS/410/CV | TPS/413/CV |
|------------------------------|--|------------------|-------------------|-------------------|
| floor thickness from / to mm | | 6,5 / 10 | 9,6 / 12,5 | 12,6 / 15,5 |
| ANODISED ALUMINIUM | | | | |
| silver | | 43430 | 43502 | 43574 |
| euro/pc | | 11,85 | 12,88 | 13,32 |

individually packed

unisystem plus

G/2/SF is a stair nosing profile of Unisystem Plus line. Composed of a base and a top profile, it is suitable for the installation of floating wooden and laminate with thicknesses from 6,5 to 12,5 mm.



G/2/SF aluminium covered with Alcrom® Plus film

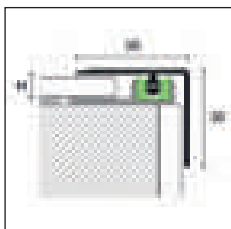

G/2/SF + TPU/

UNISYSTEM PLUS

length = 270 cm - pack 10 pcs - for floor thicknesses from 6,5 to 12,5 mm

ART. finishing

ALUMINIUM covered with ALCROM® PLUS film

| | | | | | | | | |
|---------------|---------------|-------|--|------|--------------|--|------|-------|
| | 05 | 43645 | | 41 | 43656 | | 1207 | 43668 |
| | 08 | 43646 | | 77 | 43657 | | 1208 | 43669 |
| | 12 | 43647 | | 89 | 43658 | | 1209 | 43670 |
| | 13 | 43648 | | 91 | 43659 | | 1210 | 43671 |
| | 14 | 43649 | | 93 | 43660 | | 1211 | 43672 |
| G/2/SF | 19 | 43650 | | 580 | 43661 | | 1212 | 43673 |
| | 26 | 43651 | | 1202 | 43663 | | 1213 | 43674 |
| | 32 | 43652 | | 1203 | 43664 | | 1214 | 43675 |
| | 36 | 43653 | | 1204 | 43665 | | 1215 | 43676 |
| | 39 | 43654 | | 1205 | 43666 | | 1216 | 43677 |
| | 40 | 43655 | | 1206 | 43667 | | 1217 | 43678 |
| | euro/m | | | | 12,11 | | | |

individually packed

UNISYSTEM PLUS

length = 270 cm - pack 10 pcs - for floor thicknesses from 6,5 to 12,5 mm

ART. finishing

ANODISED ALUMINIUM

| | | | | |
|---------------|---------------|--|--|-------------|
| | silver | | | 43690 |
| G/2/SF | euro/m | | | 7,22 |
| | titanium | | | 43691 |
| | euro/m | | | 7,85 |

individually packed

UNISYSTEM PLUS - BASES

floor thickness from / to mm 6,5/10 9,6/12,5

length = 270 cm - pack 20 pcs (15 clips TU/6 included)

ART. finishing 6 10 H

ALUMINIUM

| | | | | |
|-------------|-------------------|--|-------------|-------------|
| TPU/ | natural aluminium | | 67437 | 67447 |
| | euro/m | | 4,71 | 5,26 |

individually packed

SPARE CLIPS

| | |
|------------------|--------------|
| pack 150 pcs | H |
| | 6 |
| TU/6 | 68812/150 |
| euro/pack | 22,42 |

no partial packaging

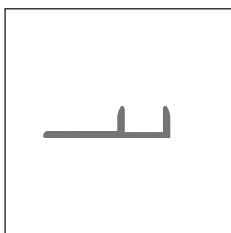

TPU/

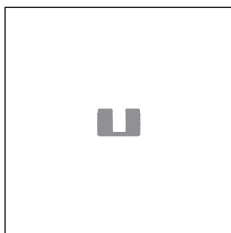

TU/6

For a single piece, see sales conditions on page 288

Customized PDS decors on request, see page 195

Profiles of 270 cm length: please order the base separately.

G/4/SF is a stair nosing profile of Unisystem Plus range, composed of a base and a top profile, for the floating installation of wooden and laminate floors with thicknesses from 6,5 to 15,5 mm.



G/4/SF aluminium covered with Alcrom® Plus film

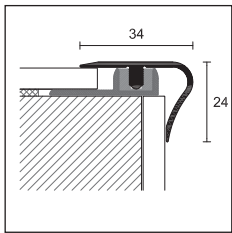

G/4/SF + TPU/

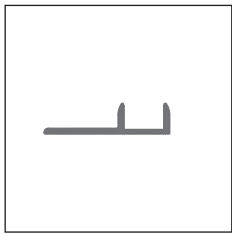

TPU/

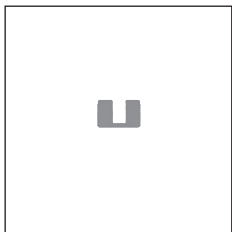

TU/6

UNISYSTEM PLUS

length = 270 cm - pack 10 pcs - for floor thicknesses from 6,5 to 15,5 mm

ART. finishing

ALUMINIUM covered with ALCROM® PLUS film

| | | | | | | | | |
|---------------|---------------|-------|--|----|--------------|--|----|-------|
| | 02 | 63905 | | 37 | 63943 | | 76 | 63956 |
| | 08 | 63907 | | 38 | 63919 | | 77 | 63937 |
| | 10 | 63910 | | 40 | 63920 | | 78 | 63934 |
| | 11 | 63911 | | 41 | 63926 | | 79 | 63938 |
| | 12 | 63913 | | 42 | 63921 | | 80 | 63935 |
| G/4/SF | 13 | 63916 | | 43 | 63927 | | 81 | 63939 |
| | 18 | 63914 | | 44 | 63929 | | 92 | 63941 |
| | 20 | 63915 | | 65 | 63931 | | 93 | 63944 |
| | 32 | 63917 | | 71 | 63951 | | 94 | 63945 |
| | 34 | 63923 | | 72 | 63952 | | 95 | 63946 |
| | 35 | 63924 | | 73 | 63953 | | | |
| | 36 | 63942 | | 74 | 63954 | | | |
| | euro/m | | | | 12,10 | | | |

individually packed

UNISYSTEM PLUS

length = 270 cm - pack 10 pcs - for floor thicknesses from 6,5 to 15,5 mm

ART. finishing

ANODISED ALUMINIUM

| | | | |
|---------------|---------------|--|-------------|
| G/4/SF | silver | | 63900 |
| | gold sand | | 63904 |
| | euro/m | | 7,18 |

individually packed

UNISYSTEM PLUS - BASES

| floor thickness from / to mm | 6,5/10 | 9,6/12,5 | 12,6/15,5 | |
|---|-------------------|-------------|-------------|-------------|
| length = 270 cm pack 20 pcs (15 clips TU/6 included) | | H | | |
| ART. finishing | 6 | 10 | 13 | |
| ALUMINIUM | | | | |
| TPU/ | natural aluminium | 67437 | 67447 | 67457 |
| | euro/m | 4,71 | 5,26 | 5,74 |

individually packed

SPARE CLIPS

| | |
|------------------|--------------|
| pack da 150 pcs | H |
| | 6 |
| TU/6 | 68812/150 |
| euro/pack | 22,42 |

no partial packaging

For a single piece, see sales conditions on page 288

Profiles of 270 cm length: please order the base separately.

Customized PDS decors on request, see page 195

profix thin

Profix Thin is a system for the floating installation of LVT floors from 4 to 8 mm thickness, composed of junction profiles for same level floors (Z/4), connection profiles for different level floors (C/4) and perimetral profiles (S/4). The system is composed of a PVC base and a top profile available in different finishes of anodised aluminium or covered with wood-, stone- or concrete-effect Alcrom® Plus film for matching the floor perfectly.



Profix Thin Z/4, C/4 e S/4

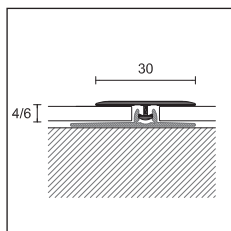

Z/4 + PT/4

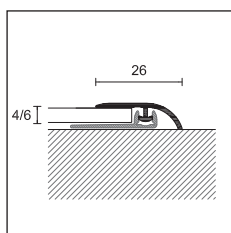

C/4 + PT/4/SA

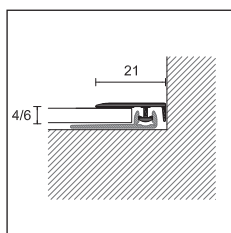

S/4 + PT/4/SA

PROFIX THIN

length = 270 cm - pack 20 pcs

for floor thickness (from 4 to 8 mm)

ALUMINIUM covered with ALCROM® PLUS film

| | Z/4 | C/4 | S/4 |
|---------------|-------------|-------------|-------------|
| 1003 | 85101 | 85201 | 85301 |
| 1006 | 85102 | 85202 | 85302 |
| 1009 | 85103 | 85203 | 85303 |
| 1012 | 85104 | 85204 | 85304 |
| 1021 | 85107 | 85207 | 85307 |
| 1024 | 85108 | 85208 | 85308 |
| 1030 | 85110 | 85210 | 85310 |
| 1033 | 85111 | 85211 | 85311 |
| 1036 | 85112 | 85212 | 85312 |
| 1042 | 85114 | 85214 | 85314 |
| 1045 | 85115 | 85215 | 85315 |
| 1051 | 85117 | 85217 | 85317 |
| 1054 | 85118 | 85218 | 85318 |
| 1057 | 85119 | 85219 | 85319 |
| 1060 | 85120 | 85220 | 85320 |
| 1063 | 85121 | 85221 | 85321 |
| 1066 | 85122 | 85222 | 85322 |
| 1069 | 85123 | 85223 | 85323 |
| 1081 | 85127 | 85227 | 85327 |
| 1084 | 85128 | 85228 | 85328 |
| 1090 | 85130 | 85230 | 85330 |
| 1105 | 85135 | 85235 | 85335 |
| 1108 | 85136 | 85236 | 85336 |
| 1111 | 85137 | 85237 | 85337 |
| euro/m | 5,41 | 5,41 | 5,41 |

individually packed

PROFIX THIN

length = 270 cm - pack 20 pcs

for floor thickness (from 4 to 8 mm)

| ART. | Z/4 | C/4 | S/4 |
|---------------------------|-------------|-------------|-------------|
| finishing | | | |
| ANODISED ALUMINIUM | | | |
| silver | 85050 | 85060 | 85070 |
| euro/m | 3,23 | 3,23 | 3,23 |
| gold sand | 85052 | 85062 | 85072 |
| titanium | 85054 | 85064 | 85074 |
| euro/m | 3,59 | 3,59 | 3,59 |
| bronze elox | 85056 | 85066 | 85076 |
| euro/m | 3,86 | 3,86 | 3,86 |

Customized PDS decors on request, see page 195

For a single piece, see sales conditions on page 288

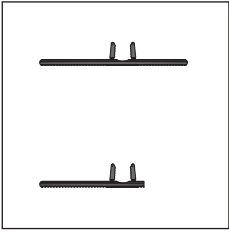

PT/4
PT/4/SA

PROFIX THIN - BASES

length = 270 cm - pack 20 pcs

for floor thickness (from 4 to 6 mm)

| ART. | PT/4 | PT/4/SA |
|-----------|-------|---------|
| finishing | | |
| PVC | | |
| green | 85081 | 85083 |
| euro/m | 1,54 | 1,53 |

To order PT/4 and PT/4/SA in pack of 100 pcs mark /100 after the article code (for example code 85081 becomes 85081/100). Pack of 100 pcs of PT/4 and PT/4/SA €/m 1,27

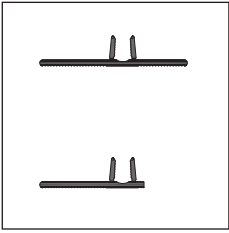

PT/6
PT/6/SA

PROFIX THIN - BASES

length = 270 cm - pack 20 pcs

for floor thickness (from 6 to 8 mm)

| ART. | NEW PT/6 | NEW PT/6/SA |
|-----------|----------|-------------|
| finishing | | |
| PVC | | |
| green | 85086 | 85088 |
| euro/m | 1,54 | 1,53 |

To order PT/6 and PT/6/SA in pack of 100 pcs mark /100 after the article code (for example code 85086 becomes 85086/100). Pack of 100 pcs of PT/6 and PT/6/SA €/m 1,27

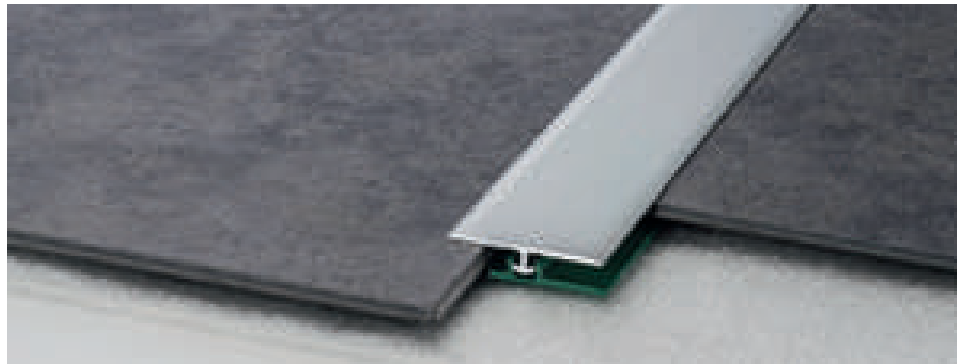

Z/4 + PT/4



C/4 + PT/4/SA

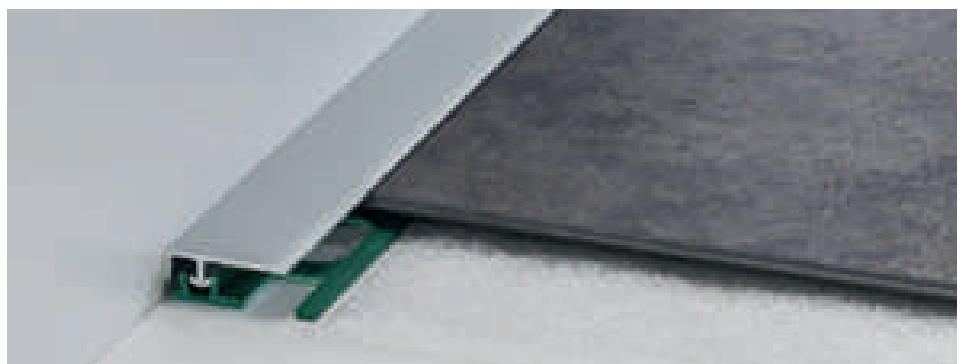

S/4 + PT/4/SA

prestowood

Prestowood 22/A, 50/A and 63/A are adhesive profiles for wooden floors of same level, different level and stairs that have been already installed. In anodised aluminium, or covered with Alcrom® Plus film, they are particularly easy and quick to install, thus becoming suitable also for the DIY.



22/A aluminium covered with Alcrom® Plus film

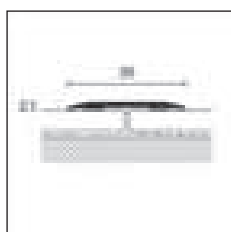

422/AD
22/A

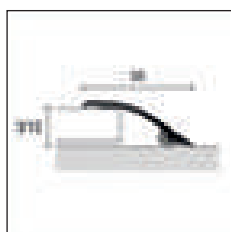









































450/AD
50/A



63/A

PRESTOWOOD





















| pack | 10 pcs / blister  | 10 pcs | 10 pcs / blister  | 10 pcs | 10 pcs | |
|---|--|--------|--|--------|--------|-------|
| length cm | 90 | 270 | 90 | 270 | 270 | |
| ART. | 422/AD | 22/A | 450/AD | 50/A | 63/A | |
| ALUMINIUM covered with ALCROM® PLUS film | | | | | | |
|  | 05 | 43700 | 43932 | 44949 | 45031 | 45140 |
|  | 08 | 43701 | 43933 | 44950 | 45032 | 45141 |
|  | 12 | 43702 | 43934 | 44951 | 45033 | 45142 |
|  | 13 | 43703 | 43935 | 44952 | 45034 | 45143 |
|  | 14 | 43704 | 43936 | 44953 | 45035 | 45144 |
|  | 19 | 43705 | 43937 | 44954 | 45036 | 45145 |
|  | 26 | 43706 | 43938 | 44955 | 45037 | 45146 |
|  | 31 | 43707 | 43939 | 44956 | 45038 | - |
|  | 32 | 43708 | 43940 | 44957 | 45039 | 45147 |
|  | 34 | 43709 | 43941 | 44958 | 45040 | - |
|  | 36 | 43710 | 43942 | 44959 | 45041 | 45148 |
|  | 39 | 43711 | 43943 | 44960 | 45042 | 45149 |
|  | 40 | 43712 | 43944 | 44961 | 45043 | 45150 |
|  | 41 | 43713 | 43945 | 44962 | 45044 | 45151 |
|  | 73 | 43714 | 43946 | 44963 | 45045 | - |
|  | 74 | 43715 | 43947 | 44964 | 45046 | - |
|  | 77 | 43716 | 43948 | 44965 | 45047 | 45152 |
|  | 79 | 43717 | 43949 | 44966 | 45048 | - |
|  | 81 | 43718 | 43950 | 44967 | 45049 | - |
|  | 89 | 43719 | 43951 | 44968 | 45050 | 45153 |
|  | 91 | 43720 | 43952 | 44969 | 45051 | 45154 |
|  | 92 | 43721 | 43953 | 44970 | 45052 | - |
|  | 93 | 43762 | 43995 | 45013 | 45094 | 45155 |
|  | 94 | 43722 | 43954 | 44971 | 45053 | - |
|  | 351 | 43723 | 43955 | 44972 | 45054 | - |
|  | 363 | 43724 | 43956 | 44973 | 45055 | - |
|  | 372 | 43725 | 43957 | 44974 | 45056 | - |
|  | 490 | 43727 | 43959 | 44976 | 45058 | - |
|  | 560 | 43728 | 43960 | 44977 | 45059 | - |
|  | 580 | 43729 | 43961 | 44978 | 45060 | 45156 |
|  | 590 | 43730 | 43962 | 44979 | 45061 | - |
|  | 665 | 43731 | 43963 | 44980 | 45062 | - |
|  | 670 | 43732 | 43964 | 44981 | 45063 | - |
|  | 951 | 43738 | 43970 | 44987 | 45069 | - |
|  | 975 | 43739 | 43971 | 44988 | 45070 | - |
|  | 1024 | 43740 | 43972 | 44989 | 45071 | - |
|  | 1033 | 43741 | 43973 | 44990 | 45072 | - |
|  | 1042 | 43742 | 43974 | 44991 | 45073 | - |
|  | 1090 | 43744 | 43976 | 44993 | 45075 | - |

 packaging in blister no partial packaging

422/AD, 450/AD and 63/A are available just for Spain and Portugal





Customized PDS decors on request, see page 195

For a single piece, see sales conditions on page 288

| pack | 10 pcs / blister  | 10 pcs | 10 pcs / blister  | 10 pcs | 10 pcs | |
|--|--|-------------|--|-------------|--------------|-------|
| length cm | 90 | 270 | 90 | 270 | 270 | |
| ART. | 422/AD | 22/A | 450/AD | 50/A | 63/A | |
| ALUMINIUM covered with ALCROM® PLUS film | | | | | | |
|  | 1202 | 43746 | 43978 | 44995 | 45077 | 45158 |
|  | 1203 | 43747 | 43979 | 44996 | 45078 | 45159 |
|  | 1204 | 43748 | 43980 | 44997 | 45079 | 45160 |
|  | 1205 | 43749 | 43981 | 44998 | 45080 | 45161 |
|  | 1206 | 43750 | 43982 | 44999 | 45081 | 45162 |
|  | 1207 | 43751 | 43983 | 45000 | 45082 | 45163 |
|  | 1208 | 43752 | 43984 | 45001 | 45083 | 45164 |
|  | 1209 | 43753 | 43985 | 45002 | 45084 | 45165 |
|  | 1210 | 43754 | 43986 | 45003 | 45085 | 45166 |
|  | 1211 | 43755 | 43987 | 45004 | 45086 | 45167 |
|  | 1212 | 43756 | 43988 | 45005 | 45087 | 45168 |
|  | 1213 | 43757 | 43989 | 45007 | 45088 | 45169 |
|  | 1214 | 43758 | 43990 | 45008 | 45089 | 45170 |
|  | 1215 | 43759 | 43991 | 45009 | 45090 | 45171 |
|  | 1216 | 43760 | 43992 | 45010 | 45091 | 45172 |
|  | 1217 | 43761 | 43993 | 45011 | 45092 | 45173 |
|  | 100 | - | 43994 | - | 45093 | - |
| NEW  | black 97 | - | 43996 | - | 45095 | 45175 |
| <i>euro/pc</i> | 8,74 | - | 8,74 | - | - | - |
| <i>euro/m</i> | - | 8,13 | - | 8,13 | 10,43 | - |

individually packed

PROCLASSIC F / PROLEVEL HIGH / PROTECT

| pack | 10 pcs / blister  | 10 pcs | 10 pcs / blister  | 10 pcs | 10 pcs | |
|---|--|-------------|--|-------------|-------------|-------|
| length cm | 90 | 270 | 90 | 270 | 270 | |
| ART. | 422/AD | 22/A | 450/AD | 50/A | 63/A | |
| ANODISED ALUMINIUM | | | | | | |
|  | silver | 43790 | 44000 | 45019 | 45100 | 45190 |
| <i>euro/pc</i> | 6,43 | - | 6,43 | - | - | |
| <i>euro/m</i> | - | 5,58 | - | 5,58 | 7,64 | |
|  | titanium | 43791 | 44001 | 45020 | 45101 | 45191 |
| <i>euro/pc</i> | 7,28 | - | 7,28 | - | - | |
| <i>euro/m</i> | - | 6,55 | - | 6,55 | 8,61 | |

individually packed

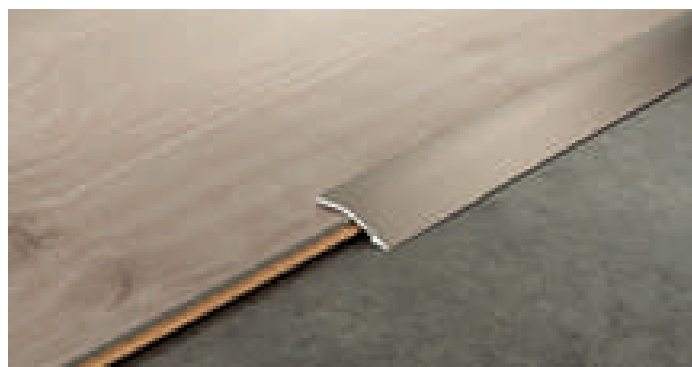

50/A titanium anodised aluminium



63/A silver anodised aluminium

prestowood

Prestowood 74/A is a line of stair nosing profiles covered with wood-effect Alcrom® Plus film, for the protection of already-laid wooden step edges. Available in adhesive version, they are particularly recommended for DIY installations.

74/ is also available in different finishes of anodised aluminium, as the stair nosing profiles 73/ and 58/.



74/A aluminium covered with Alcrom® Plus film

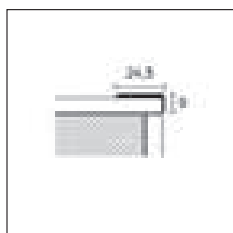

73/

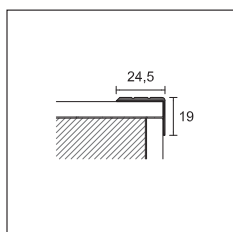

74/

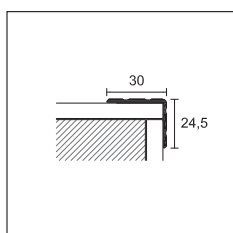

58/A

PRESTOWOOD

| | | | |
|---|----|--------------|-------------|
| pack | | | 10 pcs |
| length cm | | | 270 |
| ART. | | | 74/A |
| finishing | | | |
| ALUMINIUM covered with ALCROM® PLUS film | | | |
| | 10 | 75319 | |
| | 12 | 75297 | |
| | 13 | 75301 | |
| | 20 | 75320 | |
| | 32 | 75303 | |
| | 36 | 75304 | |
| | 37 | 75305 | |
| | 38 | 75306 | |
| | 40 | 75322 | |
| | 47 | 75307 | |
| | 65 | 75294 | |
| | 71 | 75309 | |
| | 76 | 75334 | |
| | 78 | 75311 | |
| | 80 | 75326 | |
| | 92 | 75312 | |
| | 94 | 75313 | |
| | 95 | 75314 | |
| euro/m | | 10,29 | |

individually packed

PROTECT

| | | | | | | | | |
|-------------------|------------|-------------|-------------|-------------|-------------|-------------|-------------|-------------|
| pack | 30 pcs | | | | | | 20 pcs | |
| length cm | 270 | | | | | | | |
| ART. | 73/ | | 74/ | | | 58/ | | |
| finishing | F | SF | A | F | SF | A | | |
| ALUMINIUM | | | | | | | | |
| silver anodised | | 75208 | 75209 | 75238 | 75268 | 75269 | 75298 | 75900 |
| gold anodised | | 75218 | - | 75248 | 75278 | - | 75308 | - |
| bronze anodised | | - | - | 75258 | - | - | 75318 | - |
| euro/m | | 3,84 | 3,69 | 5,06 | 4,41 | 4,26 | 5,63 | 6,25 |
| titanium anodised | | | | | | | 75299 | |
| euro/m | | | | | | | 7,15 | |

Customized PDS decors on request, see page 195

For a single piece, see sales conditions on page 288

RC is a line of edge profiles for the floating installation of wooden and laminate floors, available in different finishes of anodised aluminium or covered with wood-effect Alcrom® Plus film. This profile is also available in the bendable version RCF that can be curved with the specific Proflex Machine.

Prolevel High 732/ is a line of profiles for the protection of the perimetral border of wooden and laminate floors.



RC/9/F silver anodised aluminium

RC

length = 270 cm - pack 20 pcs

| ART. | finishing | 7 | 9 | 11 | 13 | 15 |
|------------------|-----------------|-------------|-------------|-------------|-------------|-------------|
| ALUMINIUM | | | | | | |
| | silver anodised | 67407 | 67477 | 67547 | 67617 | 67687 |
| RC/ /F | gold anodised | - | 67487 | - | - | - |
| | bronze anodised | - | 67497 | - | - | - |
| euro/m | | 4,91 | 4,98 | 5,17 | 5,45 | 5,63 |

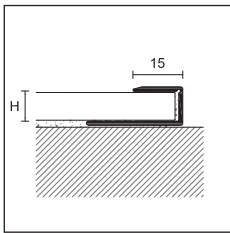

RC/ /F
RCF/

length = 270 cm - pack 10 pcs

| ART. | finishing | 7 | 9 | 11 | 13 | 15 |
|---|-----------|---|-------------|----|----|----|
| ALUMINIUM covered with ALCROM® PLUS film | | | | | | |
| | 10 | - | 66731 | - | - | - |
| | 20 | - | 66734 | - | - | - |
| | 38 | - | 66739 | - | - | - |
| RC/ /F | 40 | - | 66740 | - | - | - |
| | 42 | - | 66758 | - | - | - |
| | 65 | - | 66747 | - | - | - |
| | 78 | - | 66751 | - | - | - |
| | 80 | - | 66752 | - | - | - |
| euro/m | | - | 6,98 | - | - | - |



RCF/ silver anodised aluminium

RC

length = 90 cm - pack 10 pcs / blister

| ART. | finishing | 7 | 9 | 11 | 15 |
|------------------|-----------------|-------------|-------------|-------------|-------------|
| ALUMINIUM | | | | | |
| | silver anodised | 42782 | 41832 | 41877 | 42822 |
| | gold anodised | - | 41839 | - | - |
| euro/pc | | 5,81 | 5,87 | 6,07 | 6,47 |

PRO FLEX LINE

TERMINAL FLEX

length = 270 cm - pack 10 pcs

| ART. | finishing | 7 | 9 | 11 | 15 | 22,5 |
|------------------|-----------------|-------------|-------------|-------------|-------------|-------------|
| ALUMINIUM | | | | | | |
| RCF/ | silver anodised | 67710 | 67712 | 67714 | 67718 | 67722 |
| | euro/m | 6,99 | 7,11 | 7,22 | 7,71 | 8,85 |

individually packed

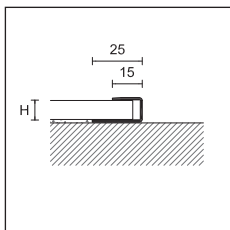

732/SF/

PROLEVEL HIGH

length = 270 cm - pack 15 pcs

| ART. | finishing | 10 | 12,5 | 15 |
|------------------------|---|--------------|--------------|--------------|
| STAINLESS STEEL | | | | |
| 732/SF/ | polished stainless steel AISI 430 DIN 1.4016 | 74217 | 74227 | 74237 |
| | euro/m | 11,19 | 12,20 | 12,20 |

individually packed

Complete the article code with H measure (for example RC/ /F for H = 9 becomes RC/9/F)

Customized PDS decors on request, see page 195

For a single piece, see sales conditions on page 288

alfix 616

Alfix 616 is a professional system for the laying of wooden and laminate floors with thickness from 6 to 16 mm. The system is composed of a top profile in anodised aluminium fixed with screws on a natural aluminium base. The screws, included in the packaging, have the same colour of the top profile in order to perfectly match it.



FIX/L/55 silver anodised aluminium

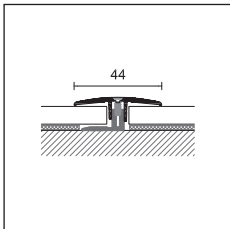

FIX/J/44

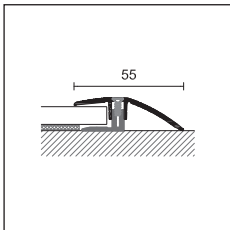

FIX/L/55

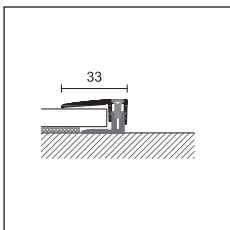

FIX/T/33

ALFIX 616

| | | | |
|-----------|--------|------------------|-----|
| pack | 10 pcs | 10 pcs / blister | |
| length cm | 270 | 90 | 100 |

ART. **FIX/J/44**

for floor thicknesses from 6 to 16 mm

finishing

ALUMINIUM

| | | | | |
|----------------------|--|--------------|--------------|--------------|
| silver anodised | | 37010 | 37012 | 37014 |
| sand gold anodised | | 37210 | 37212 | - |
| euro/m | | 15,27 | - | - |
| euro/pc | | - | 14,71 | 16,26 |
| titanium anodised | | 37410 | - | 37414 |
| elox bronze anodised | | 37310 | 37312 | 37314 |
| euro/m | | 15,98 | - | - |
| euro/pc | | - | 15,37 | 16,95 |

individually packed

ALFIX 616

| | | | |
|-----------|--------|------------------|-----|
| pack | 10 pcs | 10 pcs / blister | |
| length cm | 270 | 90 | 100 |

ART. **FIX/L/55**

for floor thicknesses from 6 to 16 mm

finishing

ALUMINIUM

| | | | | |
|----------------------|--|--------------|--------------|--------------|
| silver anodised | | 37040 | 37042 | 37044 |
| sand gold anodised | | 37240 | 37242 | 37244 |
| euro/m | | 16,64 | - | - |
| euro/pc | | - | 15,93 | 17,63 |
| titanium anodised | | 37440 | 37442 | 37444 |
| elox bronze anodised | | 37340 | - | - |
| euro/m | | 17,37 | - | - |
| euro/pc | | - | 16,49 | 18,33 |

individually packed

ALFIX 616

| | | | |
|-----------|--------|------------------|-----|
| pack | 10 pcs | 10 pcs / blister | |
| length cm | 270 | 90 | 100 |

ART. **FIX/T/33**

for floor thicknesses from 6 to 16 mm

finishing

ALUMINIUM

| | | | | |
|----------------------|--|--------------|--------------|--------------|
| silver anodised | | 37070 | - | 37074 |
| sand gold anodised | | 37270 | 37272 | - |
| euro/m | | 15,27 | - | - |
| euro/pc | | - | 14,71 | 16,26 |
| titanium anodised | | 37470 | - | 37474 |
| elox bronze anodised | | - | - | 37374 |
| euro/m | | 15,98 | - | - |
| euro/pc | | - | 15,37 | 16,95 |

individually packed

For a single piece, see sales conditions on page 288

packaging in blister no partial packaging

Alfix 46 is a professional system for the laying of LVT floors from 4 to 6 mm. This system is characterized by top profiles in anodised aluminium, fixed with a screw system on a natural aluminium base. Screws, included in the package, have the same colour of the anodisation and, once fixed, integrate with the top profile.



FIX/J/30 silver anodised aluminium



FIX/L/32 silver anodised aluminium



FIX/T/19 silver anodised aluminium

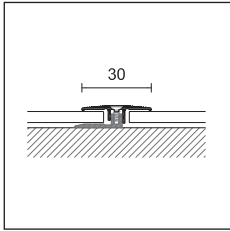

FIX/J/30

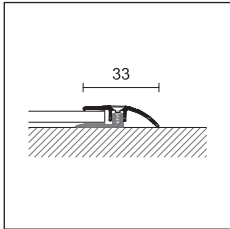

FIX/L/32

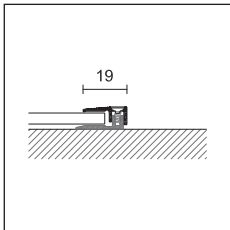

FIX/T/19

ALFIX 46

| | |
|-----------|--------|
| pack | 10 pcs |
| length cm | 270 |

ART. **FIX/J/30**

for floor thicknesses from 4 to 6 mm

finishing

ALUMINIUM

| | | |
|-----------------|---|--------------|
| silver anodised |  | 35500 |
| euro/m | | 15,33 |

individually packed

ALFIX 46

| | |
|-----------|--------|
| pack | 10 pcs |
| length cm | 270 |

ART. **FIX/L/32**

for floor thicknesses from 4 to 6 mm

finishing

ALUMINIUM

| | | |
|-----------------|---|--------------|
| silver anodised |  | 35510 |
| euro/m | | 15,33 |

individually packed

ALFIX 46

| | |
|-----------|--------|
| pack | 10 pcs |
| length cm | 270 |

ART. **FIX/T/19**

for floor thicknesses from 4 to 6 mm

finishing

ALUMINIUM

| | | |
|-----------------|---|--------------|
| silver anodised |  | 35520 |
| euro/m | | 15,33 |

individually packed

cerfix® projoint - pronivel

NZA/ is an expansion joint in aluminium composed of two interlocking and sliding profiles.

Suitable for LVT floors and tiles of small gaps, it guarantees a good resistance to loads and intense foot traffic. This item can be 3 mm high and, therefore, suitable for the application on substrate joints in glued LVT; it can also be 5 mm high and, in this case, thanks to the exclusive solution with the adhesive integrated with the internal anchor flange, it can be fixed directly to the board and it is the perfect joint for LVT floating floors with a uninterrupted surface and perfectly flat.



NZA/5A silver anodised aluminium



PBA/5A silver anodised aluminium

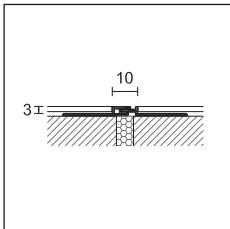

NZA/3

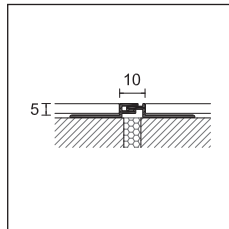

NZA/5

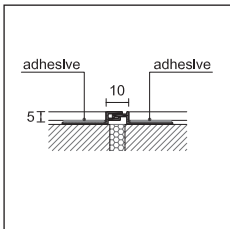

NZA/5A

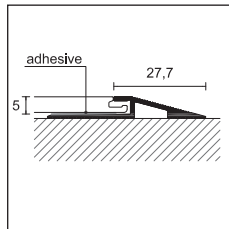

PBA/5/A

PROJOINT

length = 270 cm - pack 20 pcs

| ART. | finishing | 3 | 5 | 5A |
|------------------|----------------------|--------------|--------------|--------------|
| ALUMINIUM | | | | |
| | silver anodised | 99300 | 99320 | 99310 |
| | sand gold anodised | - | - | 99312 |
| NZA/ | euro/m | 15,33 | 15,72 | 17,75 |
| | titanium anodised | - | - | 99314 |
| | elox bronze anodised | - | - | 99316 |
| | euro/m | - | - | 18,55 |

individually packed

PRONIVEL

length = 270 cm - pack 10 pcs

| ART. | finishing | 5 |
|------------------|-----------------|-------------|
| ALUMINIUM | | |
| PBA/5/A | silver anodised | 93205 |
| | euro/m | 8,87 |

individually packed

NTA/ and NTI/ are expansion joints that are also ideal for glued LVT floors and that should be installed in line with the substrate joints.



NTA/3 natural aluminium + EPDM grey

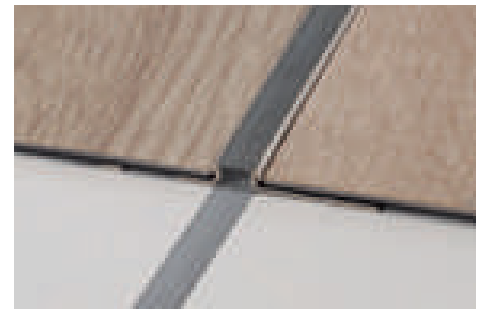

NTI/3 stainless steel + EPDM grey

PROJOINT DIL

length = 270 cm - pack 10 pcs

| ART. | finishing | 3 | H |
|------------------|--|--------------|---|
| ALUMINIUM | | | |
| | natural aluminium + EPDM grey polishable RAL 7046 | 99421 | |
| | natural aluminium + EPDM black polishable RAL 9005 | 99422 | |
| NTA/ | natural aluminium + EPDM bahama polishable RAL 10070 | 99427 | |
| | natural aluminium + EPDM brown polishable RAL 10071 | 99429 | |
| | euro/m | 21,35 | |

PROJOINT DIL

length = 270 cm - pack 10 pcs

| ART. | finishing | 3 | H |
|------------------------|---|--------------|---|
| STAINLESS STEEL | | | |
| | stainless steel AISI 304 DIN 1.4301 + EPDM grey RAL 7046 | 99471 | |
| | stainless steel AISI 304 DIN 1.4301 + EPDM black RAL 9005 | 99472 | |
| NTI/ | stainless steel AISI 304 DIN 1.4301 + EPDM bahama RAL 10070 | 99431 | |
| | stainless steel AISI 304 DIN 1.4301 + EPDM brown RAL 10071 | 99433 | |
| | euro/m | 32,84 | |

H/5/F, PBAS/5/F, RC/5/F and 99/TR/26 are connection profiles in anodised aluminium, for floating LVT floors and suitable as profiles for same height, different height and for borders.



H/5/F silver anodised aluminium



PBAS/5/S silver anodised aluminium

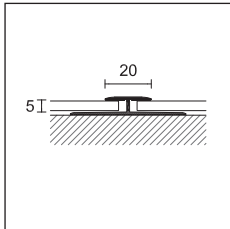

H/5/F

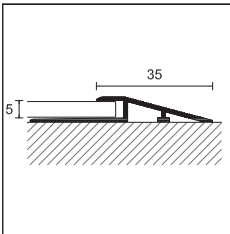

PBAS/5/F

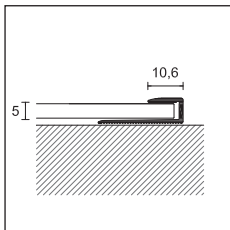

RC/5/F

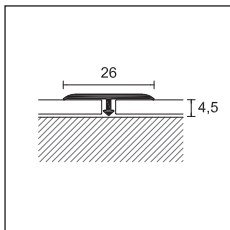

99/TR/26

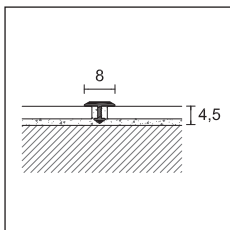

99/T/8

PROJOINT T

| | | |
|-------------------------------|------------------|----------|
| length = 270 cm - pack 20 pcs | | H |
| ART. | finishing | 5 |
| ALUMINIUM | | |
| H/5/F drilled | silver anodised | 75000 |
| | euro/m | 7,13 |

individually packed

PRONIVEL PB

| | | |
|-------------------------------|------------------|----------|
| length = 270 cm - pack 20 pcs | | H |
| ART. | finishing | 5 |
| ALUMINIUM | | |
| PBAS/5/F drilled | silver anodised | 95203 |
| | euro/m | 7,13 |

individually packed

RC

| | | |
|-------------------------------|------------------|----------|
| length = 270 cm - pack 20 pcs | | H |
| ART. | finishing | 5 |
| ALUMINIUM | | |
| RC/5/F drilled | silver anodised | 67475 |
| | euro/m | 4,84 |

individually packed

PROJOINT T

| | | |
|-------------------------------|------------------|-----------------|
| length = 270 cm - pack 20 pcs | | LxH |
| ART. | finishing | 26 x 4,5 |
| ALUMINIUM | | |
| 99/TR/26 | silver anodised | 75081 |
| | euro/m | 4,57 |

individually packed

PROJOINT T - SEPARATION JOINTS

| | | |
|------------------------|------------------|---------------|
| length = 270 cm - pack | | 50 pcs |
| width | | 8 |
| ART. | finishing | |
| ALUMINIUM | | |
| | silver anodised | 75075 |
| 99/T/ | gold anodised | - |
| | euro/m | 3,18 |
| length = 270 cm - pack | | 50 pcs |
| BRASS | | |
| 399/T/ | polished | 75070 |
| | euro/m | 6,50 |
| pack | | 30 pcs |
| 399/TC/ | chromium plated | 75071 |
| | euro/m | 13,16 |

individually packed

prostep - protect

SMA/, 75/F, 111/ /F and G/705/F are profiles in anodised aluminium suitable for stairs covered with glued LVT. ZGF/ is a profile in aluminium suitable for following the curvilinear course of stairs or floors in glued LVT.



SMA/4 silver anodised aluminium



75/F silver anodised aluminium

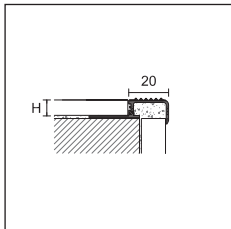

SMA/4

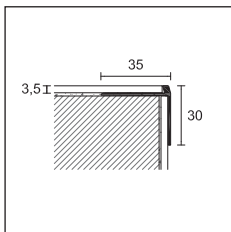

75/F

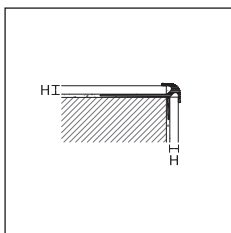

111/

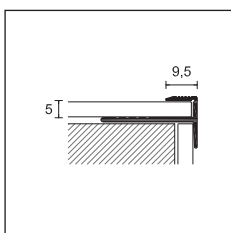

G/705/F

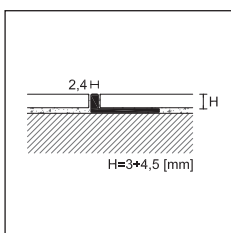

ZGF/

PROSTEP

length = 270 cm - pack 10 pcs

H

ART. finishing

4,5

ALUMINIUM

| | | | |
|------|-------------------|--|-------|
| SMA/ | natural aluminium | | 93967 |
| | euro/m | | 6,26 |
| SMA/ | silver anodised | | 93975 |
| | euro/m | | 7,52 |

individually packed

PROTECT

length = 340 cm - pack 20 pcs

H

ART. finishing

3,5

ALUMINIUM

| | | | |
|------|-------------------------|--|-------|
| 75/F | drilled silver anodised | | 75388 |
| | euro/m | | 6,45 |

PROTECT

length = 270 cm - pack 20 pcs

H

ART. finishing

2,5

4,5

5

ALUMINIUM

| | | | | | |
|---------|-----------------|--|-------|-------|-------|
| 111/ /F | silver anodised | | 75782 | 75784 | 75785 |
| | euro/m | | 6,77 | 7,13 | 7,38 |

PROSTEP

length = 270 cm - pack 10 pcs

H

ART. finishing

5

ALUMINIUM

| | | | |
|---------|-----------------|--|-------|
| G/705/F | silver anodised | | 67580 |
| | euro/m | | 7,39 |

individually packed

PRO FLEX LINE

PROANGLE FLEX

length = 270 cm - pack 10 pcs

H

ART. finishing

4,5

ALUMINIUM

| | | | |
|------|-------------------|--|-------|
| ZGF/ | natural aluminium | | 88721 |
| | euro/m | | 3,13 |

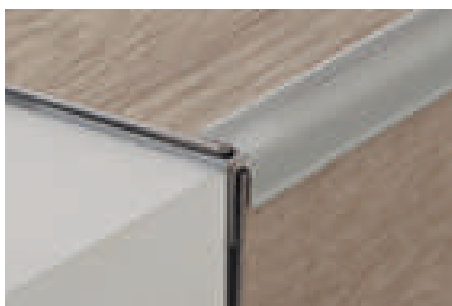

111/2,5/F silver anodised aluminium



G/705/F silver anodised aluminium

For a single piece, see sales conditions on page 288

cerfix® protrim - proangle

RA/ and RI/ are profiles that are ideal for LVT coverings and are recommended as border profiles for floors or stairs finishing.

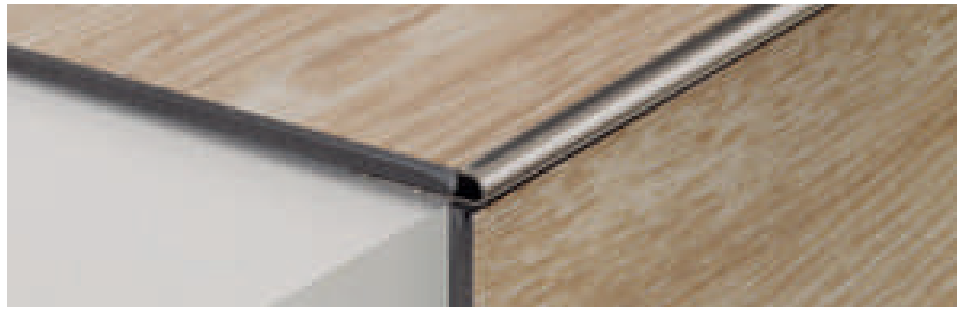

RI/4 stainless steel AISI 304 - DIN 1.4301

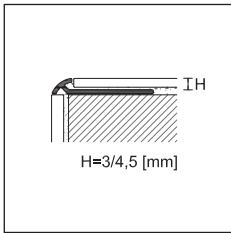

RA/

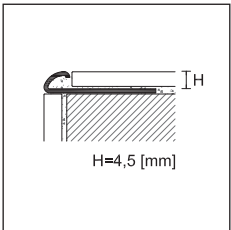

RI/

ZA/, AI/, ZQAN/, ZQKN/ and ZK/ are profiles suitable for LVT coverings and are recommended as connection and border profiles.

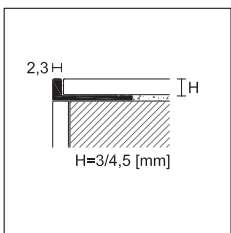

ZA/

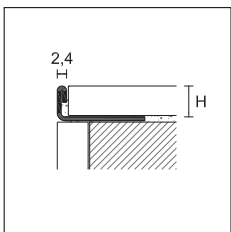

AI/

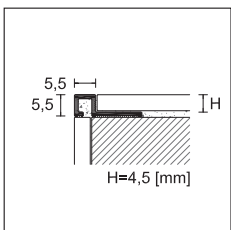

ZQAN/
ZQKN/

PROTRIM

length = 270 cm - pack 20 pcs

| | | H | |
|------------------|-------------------|-------------|-------------|
| ART. | finishing | 3 | 4,5 |
| ALUMINIUM | | | |
| | silver anodised | 92055 | 92056 |
| | gold anodised | 92025 | 92026 |
| RA/ | euro/m | 3,77 | 3,98 |
| | titanium anodised | 92085 | 92086 |
| | euro/m | 4,40 | 4,61 |

individually packed

PROTRIM

length = 270 cm - pack 20 pcs

| | | H | |
|------------------------|-------------------------------------|-------------|--|
| ART. | finishing | 4,5 | |
| STAINLESS STEEL | | | |
| RI/ | stainless steel AISI 304 DIN 1.4301 | 92413 | |
| | euro/m | 8,27 | |

individually packed

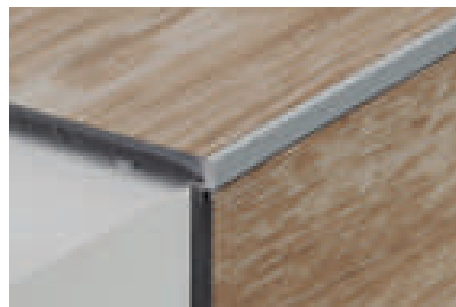

ZA/4 silver anodised aluminium

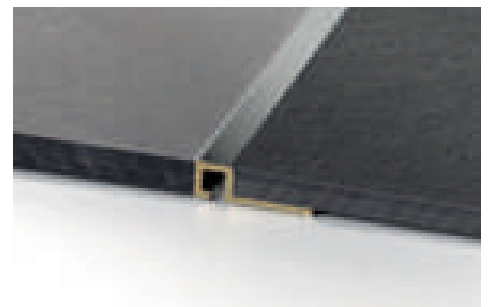

ZQKN/4 chromium-plated brass

PROANGLE

length = 270 cm - pack 20 pcs

| | | H | | |
|------------------------|-------------------------------------|-------------|-------------|-------------|
| ART. | finishing | 2,5 | 3 | 4,5 |
| ALUMINIUM | | | | |
| ZA/ | silver anodised | 90337 | 90338 | 90340 |
| | euro/m | 2,95 | 2,95 | 3,08 |
| STAINLESS STEEL | | | | |
| AI/ | stainless steel AISI 304 DIN 1.4301 | - | 91636 | 91638 |
| | euro/m | - | 6,98 | 7,11 |

individually packed - version chromium - plated brass article ZK/3 and ZK/4,5 see page 29

PROANGLE Q

length = 270 cm - pack 20 pcs

| | | H | |
|------------------|-------------------|--------------|--|
| ART. | finishing | 4,5 | |
| ALUMINIUM | | | |
| | silver anodised | 88772 | |
| ZQAN/ | euro/m | 4,53 | |
| | titanium anodised | 88902 | |
| | euro/m | 5,16 | |
| BRASS | | | |
| ZQKN/ | chromium plated | 88870 | |
| | euro/m | 16,33 | |

individually packed

cerfix® proround

GA/, JGA/ and PIA/ are connection profiles for stairs in glued LVT. Easy to lay, they facilitate the hygienic maintenance of the connection between tread and riser.

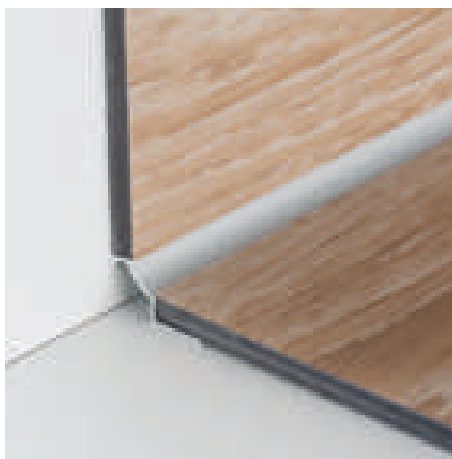

GA/4 silver anodised aluminium



JGA/4 silver anodised aluminium

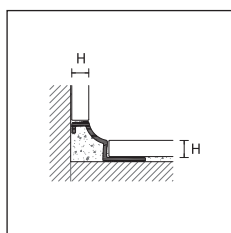

GA/

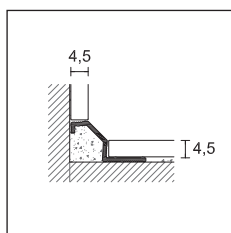

JGA/

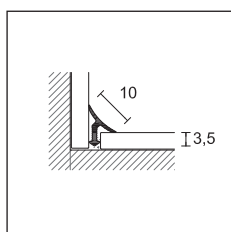

PIA/

PROROUND M

length = 270 cm - pack 20 pcs

| | | | |
|------------------|------------------|--|-------------|
| ART. | finishing | | 4,5 |
| ALUMINIUM | | | |
| GA/ | silver anodised | | 95730 |
| | <i>euro/m</i> | | 7,36 |

individually packed

PROROUND M

length = 270 cm - pack 20 pcs

| | | | |
|------------------|------------------|--|-------------|
| ART. | finishing | | H |
| ALUMINIUM | | | |
| JGA/ | silver anodised | | 95732 |
| | <i>euro/m</i> | | 7,36 |

individually packed

PROINT

length = 270 cm - pack 20 pcs

| | | | |
|------------------|------------------|--|-------------|
| ART. | finishing | | 3,5 |
| ALUMINIUM | | | |
| PIA/ | silver anodised | | 95431 |
| | <i>euro/m</i> | | 4,99 |

individually packed



PIA/3 silver anodised aluminium

For a single piece, see sales conditions on page 288

PVC Line skirting boards for wooden, laminate and LVT floors



PVC Line 8605 covered with Alcrom® Plus film, see page 216



PVC Line 8608 covered with Alcrom® Plus film, see page 217



PVC Line 8615 covered with Alcrom® Plus film, see page 218



PVC Line 8613 covered with Alcrom® Plus film, see page 219



PVC Line 8612 covered with Alcrom® Plus film, see page 220



PVC Line 8614 covered with Alcrom® Plus film, see page 220

Profilpas Digital System no limits to imagination



Profilpas gives the possibility to choose between over 400 standard decors Alcrom® Plus to combine the chosen profile or skirting board with the floor perfectly: indeed, a wide selection of wood, stone or concrete decors is available in our database to meet every need.

Just consult our PDS bunch to discover the decor that best suits to your wish of combination.

But that's not all. The possibility of customization is really limitless with Profilpas. We just need to

receive a sample for creating any further decor, even a fantasy one!

This is possible thanks to Profilpas Digital System (PDS), the innovative digital printing technology of Profilpas to reproduce any decor on Alcrom Plus film and not to give limits to imagination! The whole production process is made inside our factory: from the scanner to the printing and the application of the film.

Please note: for customizations with decors that are not in our database, there is an extra of 165 € for decor.

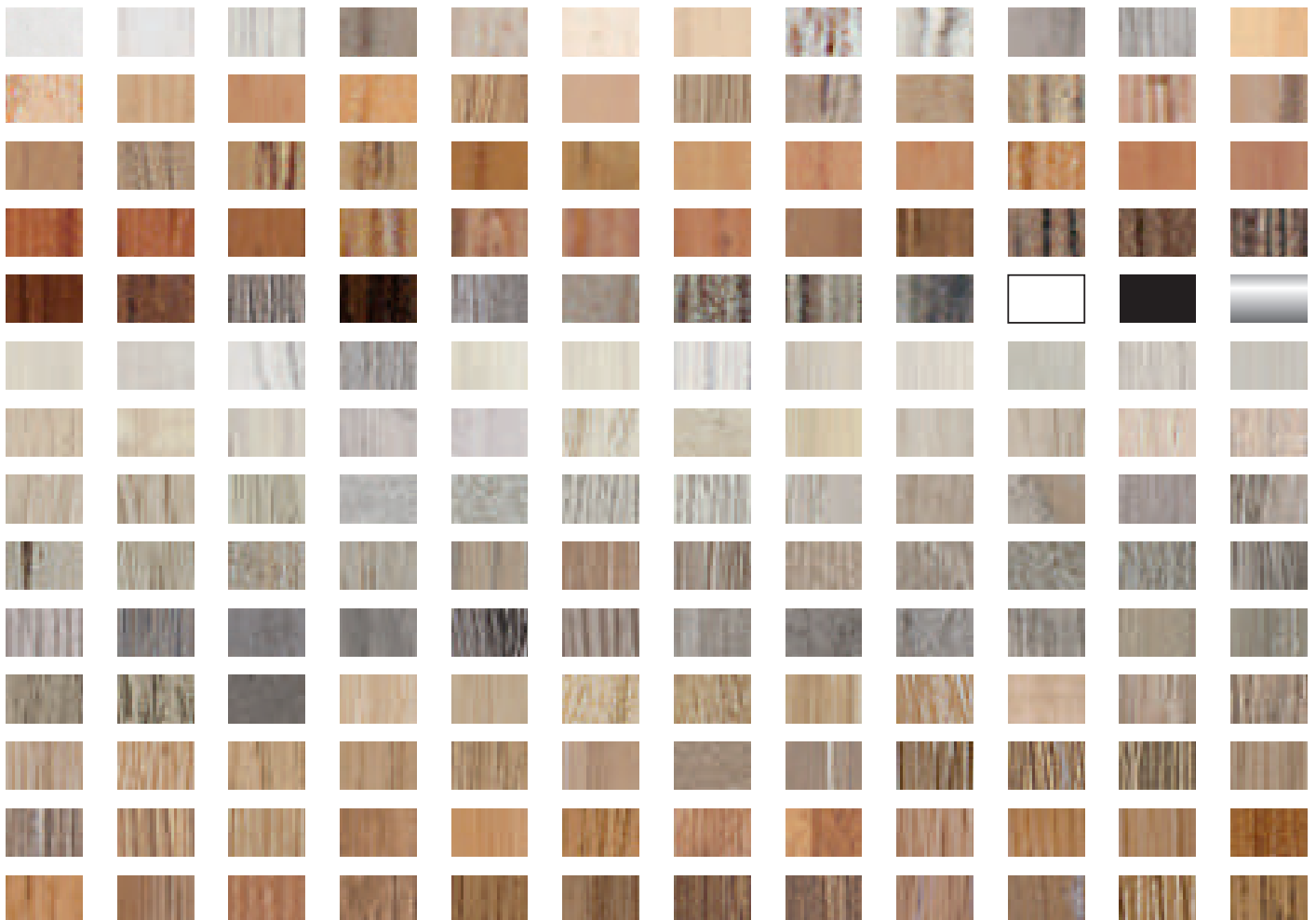



**UNISYSTEM PLUS Z/1, C/7, S/9
PROFIX THIN Z/4, C/4 AND S/4**

Quantity 20 pcs / 54 m = + 4,93 €/m

Quantity 40 pcs / 108 m = + 4,44 €/m

Quantity 60 pcs / 162 m = + 3,96 €/m

Quantity 80 pcs / 216 m = + 3,45 €/m

Quantity 100 pcs / 270 m = + 2,95 €/m

min. 54 m

Quantity 120 pcs / 324 m = + 2,45 €/m

Quantity 140 pcs / 378 m = + 1,98 €/m

Quantity 160 pcs / 432 m = + 1,47 €/m

Quantity 180 pcs / 486 m = + 0,98 €/m

Quantity 200 pcs / 540 m = + 0,00 €/m

Z3/30, C/10, C/13, C/22 E S/15

min. 540 m divisible into 5 decors

UNISYSTEM PLUS G/2 AND G/4

min. 540 m divisible into 5 decors

22/A, 50/A AND 63/A

min. 540 m divisible into 5 decors

74/A

min. 540 m divisible into 5 decors

RC/ /F

min. 540 m divisible into 5 decors

PVC LINE 8605, 8606, 8608, 8615, 8616, 8612, 8613 AND 8614

min. 540 m divisible into 2 decors

For the customization of other articles, please contact our Sales Department.

Please note: for customizations with decors that are not in our database, there is an extra of 165 € for decor.



WOOD,
LAMINATE, LVT





metal line skirting board

To choose Metal Line means giving importance to details because they are the ones who make the difference. Metal Line is distinguished by its versatility and functionality, but also for its inspiration to contemporary design. It is an innovative line, rich of solutions with a wide variety of combinations and colours capable of satisfying every housing need, from small and large gathering places. Stainless steel and aluminium, materials that give shape, colour and size to the space, minimalist signs that follow the flow of everyday life. Metal Line can provide a continuum of profiles that integrate perfectly into environments and different styles, enhancing their aesthetic and architectural appeal. Metal Line becomes a trend line, thanks to Profilpas research on materials and shapes and to the attention of the company to the world of furniture and design.

skirting board metal line

Metal Line 90 is an aluminium skirting board, available in different finishes, that creates an elegant junction between the wall and the floor. Thanks to the curved section, this skirting board perfectly hides the perimetral expansion gap of a floating floor. Metal Line 90 is also available in white and black Trend Color Stone, two matt colours that perfectly match the most modern ceramic coverings. All the models can be curved through the specific Proflex Machine.

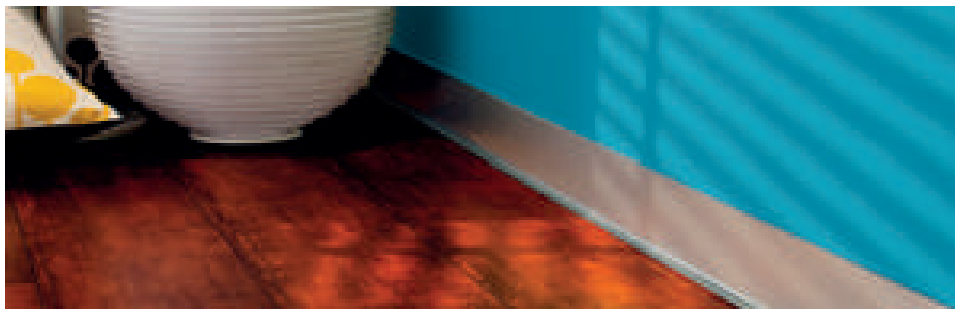

90/10 silver anodised aluminium

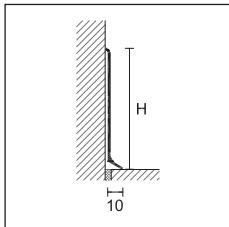

Metal Line 90 colour-coated aluminium white stone

TREND
COLOR

METAL LINE 90

length = 200 cm- pack 25 pcs

| ART. | finishing | H cm | | | | | |
|--|--|--------------|--------------|--------------|-------------|--------------|--------------|
| | | 4 | 5 | 6 | 7 | 8 | 10 |
| ALUMINIUM | | | | | | | |
| | silver anodised | 78080 | 78084 | 78100 | 78138 | 78130 | 78137 |
| | colour-coated polished white RAL 9010 | - | - | 78112 | - | - | - |
| | colour-coated matt white RAL 9010 | - | - | 78110 | - | - | - |
| | euro/m | 6,08 | 6,80 | 7,40 | 8,41 | 9,41 | 12,14 |
| 90/ SF | titanium anodised | - | - | 78103 | - | - | - |
| | euro/m | - | - | 10,19 | - | - | - |
| | colour-coated anthracite grey | - | - | 78118 | - | - | - |
| | colour-coated ancient grey | - | - | 78119 | - | - | - |
| | euro/m | - | - | 10,78 | - | - | - |
| 90/ A | self-adhesive silver anodised | - | - | 78106 | - | 78136 | - |
| | euro/m | - | - | 9,31 | - | 11,37 | - |
| 90/ TSF | bright polished titanium | - | 78087 | 78111 | - | 78141 | - |
| 90/ SSF | bright satin silver | 78082 | - | 78105 | - | 78133 | - |
| | bright satin gold | - | - | 78107 | - | 78135 | - |
| | euro/m | 9,65 | 10,68 | 11,14 | - | 14,24 | - |
| 90/ TMSF | bright satin titanium | 78088 | - | 78102 | - | 78134 | - |
| | euro/m | 11,20 | - | 13,71 | - | 17,89 | - |
| TREND COLOR STONE | | | | | | | |
| 90/ SF | colour-coated white stone | - | - | 78094 | - | - | - |
| | colour-coated black stone | - | - | 78099 | - | - | - |
| | euro/m | - | - | 10,78 | - | - | - |
| ANTIBACTERIAL COLOUR-COATED ALUMINIUM | | | | | | | |
| NEW 90H/ SF | colour-coated white RAL 9003 antibacterial | - | - | 78104 | - | - | - |
| | euro/m | - | - | 13,72 | - | - | - |

individually packed

90/4SF, 90/5SF, 90/6SF and 90/8SF in silver anodised aluminium, available also in length 400 cm

PROFLEX LINE

Metal Line 90 can be curved by using Proflex Machine + wheels kit for Metal Line 90 (vedi pag 267)

The self-adhesive version in height 4, 5, 7, and 10 is available on request, with a minimum order of 200 meters and a surcharge of 2,04 €/mt

RAL 9003, RAL 7038, RAL 8019, RAL 9006, RAL 9007 colour-coated aluminium skirting boards are available on request, with a minimum order of 300 meters. For other colours, please contact our sales department.

Complete the article code with H measure (for example 90/SF for H=4 becomes 90/4SF)

For a single piece, see sales conditions on page 288



inside corner, outside corner, junction and right-left end caps

INSIDE CORNER

| pack 4 pcs | | H cm | | | | | |
|--------------|------------------------------|-------|-------|-------|-------|-------|-------|
| ART. | finishing | 4 | 5 | 6 | 7 | 8 | 10 |
| METAL | | | | | | | |
| 90/ MI | silver | 78630 | 78640 | 78650 | 78660 | 78670 | 78680 |
| | <i>euro/pc</i> | 5,41 | 5,41 | 5,41 | 5,41 | 5,41 | 5,41 |
| | titanium | - | - | 78654 | - | - | - |
| | polished white RAL 9010 | - | - | 78664 | - | - | - |
| | matt white RAL 9010 | - | - | 78674 | - | - | - |
| | anthracite grey | - | - | 78684 | - | - | - |
| | ancient grey | - | - | 78694 | - | - | - |
| | polished titanium | - | 78644 | 78704 | - | 78708 | - |
| | satin silver | 78718 | - | 78720 | - | 78722 | - |
| | satin gold | - | - | 78724 | - | 78744 | - |
| | satin titanium | 78714 | - | 78734 | - | 78754 | - |
| | <i>euro/pc</i> | 5,90 | 5,90 | 5,90 | - | 5,90 | - |
| 90/ MI | white stone | - | - | 78172 | - | - | - |
| | black stone | - | - | 78173 | - | - | - |
| | <i>euro/pc</i> | - | - | 6,55 | - | - | - |
| 90H/ MI | white RAL 9003 antibacterial | - | - | 78690 | - | - | - |
| | <i>euro/pc</i> | - | - | 6,99 | - | - | - |

POLYPROPYLENE

| | | | | | | | |
|-------|-----------------|-------|-------|-------|-------|-------|-------|
| 90/ I | silver anodised | 78236 | 78231 | 78190 | 78370 | 78195 | 78091 |
| | <i>euro/pc</i> | 2,72 | 2,72 | 2,72 | 2,72 | 2,72 | 2,72 |

no partial packaging

JUNCTION

| pack 4 pcs | | H cm | | | | | |
|--------------|------------------------------|-------|-------|-------|-------|-------|-------|
| ART. | finishing | 4 | 5 | 6 | 7 | 8 | 10 |
| METAL | | | | | | | |
| 90/ MG | silver | 78632 | 78642 | 78652 | 78662 | 78672 | 78682 |
| | <i>euro/pc</i> | 5,41 | 5,41 | 5,41 | 5,41 | 5,41 | 5,41 |
| | titanium | - | - | 78656 | - | - | - |
| | polished white RAL 9010 | - | - | 78666 | - | - | - |
| | matt white RAL 9010 | - | - | 78676 | - | - | - |
| | anthracite grey | - | - | 78686 | - | - | - |
| | ancient grey | - | - | 78696 | - | - | - |
| | polished titanium | - | 78646 | 78706 | - | 78710 | - |
| | satin silver | 78738 | - | 78740 | - | 78742 | - |
| | satin gold | - | - | 78726 | - | 78746 | - |
| | satin titanium | 78716 | - | 78736 | - | 78756 | - |
| | <i>euro/pc</i> | 5,90 | 5,90 | 5,90 | - | 5,90 | - |
| 90/ MG | white stone | - | - | 78187 | - | - | - |
| | black stone | - | - | 78188 | - | - | - |
| | <i>euro/pc</i> | - | - | 6,55 | - | - | - |
| 90H/ MG | white RAL 9003 antibacterial | - | - | 78692 | - | - | - |
| | <i>euro/pc</i> | - | - | 6,99 | - | - | - |

POLYPROPYLENE

| | | | | | | | |
|-------|-----------------|-------|-------|-------|-------|-------|-------|
| 90/ G | silver anodised | 78237 | 78232 | 78192 | 78372 | 78197 | 78092 |
| | <i>euro/pc</i> | 2,72 | 2,72 | 2,72 | 2,72 | 2,72 | 2,72 |

no partial packaging

OUTSIDE CORNER

| pack 4 pcs | | H cm | | | | | |
|--------------|------------------------------|-------|-------|-------|-------|-------|-------|
| ART. | finishing | 4 | 5 | 6 | 7 | 8 | 10 |
| METAL | | | | | | | |
| 90/ ME | silver | 78631 | 78641 | 78651 | 78661 | 78671 | 78681 |
| | <i>euro/pc</i> | 5,41 | 5,41 | 5,41 | 5,41 | 5,41 | 5,41 |
| | titanium | - | - | 78655 | - | - | - |
| | polished white RAL 9010 | - | - | 78665 | - | - | - |
| | matt white RAL 9010 | - | - | 78675 | - | - | - |
| | anthracite grey | - | - | 78685 | - | - | - |
| | ancient grey | - | - | 78695 | - | - | - |
| | polished titanium | - | 78645 | 78705 | - | 78709 | - |
| | satin silver | 78728 | - | 78730 | - | 78732 | - |
| | satin gold | - | - | 78725 | - | 78745 | - |
| | satin titanium | 78715 | - | 78735 | - | 78755 | - |
| | <i>euro/pc</i> | 5,90 | 5,90 | 5,90 | - | 5,90 | - |
| 90/ ME | white stone | - | - | 78174 | - | - | - |
| | black stone | - | - | 78178 | - | - | - |
| | <i>euro/pc</i> | - | - | 6,55 | - | - | - |
| 90H/ ME | white RAL 9003 antibacterial | - | - | 78691 | - | - | - |
| | <i>euro/pc</i> | - | - | 6,99 | - | - | - |

POLYPROPYLENE

| | | | | | | | |
|-------|-----------------|-------|-------|-------|-------|-------|-------|
| 90/ E | silver anodised | 78235 | 78230 | 78191 | 78371 | 78196 | 78090 |
| | <i>euro/pc</i> | 2,72 | 2,72 | 2,72 | 2,72 | 2,72 | 2,72 |

no partial packaging

RIGHT/LEFT END CAPS

| 4 couples pack | | H cm | | | | | |
|----------------|------------------------------|-------|-------|-------|-------|-------|-------|
| ART. | finishing | 4 | 5 | 6 | 7 | 8 | 10 |
| METAL | | | | | | | |
| 90/ MP | silver | 78633 | 78643 | 78653 | 78663 | 78673 | 78683 |
| | <i>euro/couple</i> | 5,65 | 5,65 | 5,65 | 5,65 | 5,65 | 5,65 |
| | titanium | - | - | 78657 | - | - | - |
| | polished white RAL 9010 | - | - | 78667 | - | - | - |
| | matt white RAL 9010 | - | - | 78677 | - | - | - |
| | anthracite grey | - | - | 78687 | - | - | - |
| | ancient grey | - | - | 78697 | - | - | - |
| | polished titanium | - | 78647 | 78707 | - | 78711 | - |
| | satin silver | 78748 | - | 78750 | - | 78752 | - |
| | satin gold | - | - | 78727 | - | 78747 | - |
| | satin titanium | 78717 | - | 78737 | - | 78757 | - |
| | <i>euro/couple</i> | 6,16 | 6,16 | 6,16 | - | 6,16 | - |
| 90/ MP | white stone | - | - | 78189 | - | - | - |
| | black stone | - | - | 78199 | - | - | - |
| | <i>euro/couple</i> | - | - | 6,79 | - | - | - |
| 90H/ MP | white RAL 9003 antibacterial | - | - | 78693 | - | - | - |
| | <i>euro/couple</i> | - | - | 7,25 | - | - | - |

POLYPROPYLENE

| | | | | | | | |
|-------|--------------------|-------|-------|-------|-------|-------|-------|
| 90/ P | silver anodised | 78238 | 78233 | 78193 | 78373 | 78198 | 78093 |
| | <i>euro/couple</i> | 2,72 | 2,72 | 2,72 | 2,72 | 2,72 | 2,72 |

no partial packaging

On request, corners in pack of 1 pc in blister + 1,47 € (in this case 90/6/MI code 78654 becomes 78654/B) - Complete the article code with the height H (for example 90/ MI with H=4 becomes 90/4MI)

For a single piece, see sales conditions on page 288

skirting board metal line

Metal Line 790 is a skirting board in polished or satin stainless steel, available in different heights, that follows the minimalist trends of modern design. Thanks to the curved section, this skirting board perfectly hides the perimetral expansion gap of a floating floor. Metal Line 790 can be easily and quickly installed through specific adhesives.



790/6 polished stainless steel AISI 304 DIN 1.4301

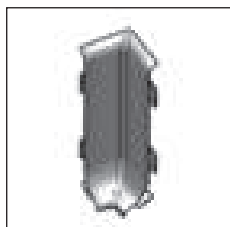
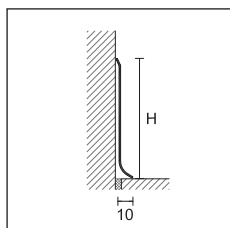

790/MI
790/MIS

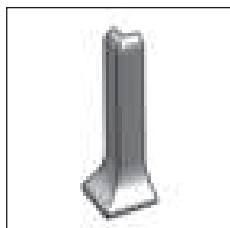

790/ME
790/MES

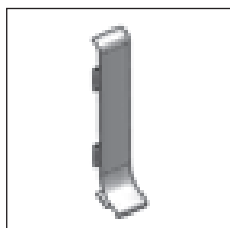

790/MG
790/MGS

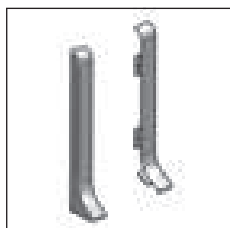

790/MP
790/MPS

On request, corners in pack of 1 pc in blister + 1,47 € (in this case 790/6/MI code 78762 becomes 78762/B)

The self-adhesive version is available in every height on request, with a minimum order of 200 meters and a surcharge of 2,04 €/m

Complete the article code with H measure (for example 790/SF for H=4 becomes 790/4SF)

For a single piece, see sales conditions on page 288

METAL LINE 790

length = 270 cm - pack 10 pcs

| | | H cm | | | | | |
|------------------------|--|------|-------------|--------------|--------------|--------------|--------------|
| ART. | finishing | 4 | 5 | 6 | 8 | 10 | |
| STAINLESS STEEL | | | | | | | |
| 790/ SF | polished stainless steel AISI 304 DIN 14301 | | 78120 | 78108 | 78129 | 78132 | 78139 |
| | <i>euro/m</i> | | 7,07 | 8,75 | 10,49 | 13,70 | 17,02 |
| | satin stainless steel AISI 304 DIN 1.4301 | | 78128 | 78109 | 78126 | 78127 | 78140 |
| | <i>euro/m</i> | | 9,49 | 11,21 | 13,47 | 17,89 | 21,87 |

individually packed - art. 790/10 SF pack 5 pcs

INSIDE CORNER IN METAL

pack 4 pcs

| | | H cm | | | | | |
|----------|--------------------|------|--------------|--------------|--------------|--------------|--------------|
| ART. | finishing | 4 | 5 | 6 | 8 | 10 | |
| 790/ MI | finishing polished | | 78760 | 78761 | 78762 | 78763 | 78764 |
| | <i>euro/pc</i> | | 8,44 | 8,44 | 8,44 | 8,44 | 8,44 |
| 790/ MIS | finishing satin | | 78780 | 78781 | 78782 | 78783 | 78784 |
| | <i>euro/pc</i> | | 11,97 | 11,97 | 11,97 | 11,97 | 11,97 |

no partial packaging

OUTSIDE CORNER IN METAL

pack 4 pcs

| | | H cm | | | | | |
|----------|--------------------|------|--------------|--------------|--------------|--------------|--------------|
| ART. | finishing | 4 | 5 | 6 | 8 | 10 | |
| 790/ ME | finishing polished | | 78765 | 78766 | 78767 | 78768 | 78769 |
| | <i>euro/pc</i> | | 8,44 | 8,44 | 8,44 | 8,44 | 8,44 |
| 790/ MES | finishing satin | | 78785 | 78786 | 78787 | 78788 | 78789 |
| | <i>euro/pc</i> | | 10,96 | 10,96 | 10,96 | 10,96 | 10,96 |

no partial packaging

JUNCTION IN METAL

pack 4 pcs

| | | H cm | | | | | |
|----------|--------------------|------|--------------|--------------|--------------|--------------|--------------|
| ART. | finishing | 4 | 5 | 6 | 8 | 10 | |
| 790/ MG | finishing polished | | 78770 | 78771 | 78772 | 78773 | 78774 |
| | <i>euro/pc</i> | | 8,44 | 8,44 | 8,44 | 8,44 | 8,44 |
| 790/ MGS | finishing satin | | 78790 | 78791 | 78792 | 78793 | 78794 |
| | <i>euro/pc</i> | | 10,96 | 10,96 | 10,96 | 10,96 | 10,96 |

no partial packaging

RIGHT/LEFT END CAPS IN METAL

4 couples pack

| | | H cm | | | | | |
|----------|--------------------|------|--------------|--------------|--------------|--------------|--------------|
| ART. | finishing | 4 | 5 | 6 | 8 | 10 | |
| 790/ MP | finishing polished | | 78775 | 78776 | 78777 | 78778 | 78779 |
| | <i>euro/couple</i> | | 8,96 | 8,96 | 8,96 | 8,96 | 8,96 |
| 790/ MPS | finishing satin | | 78795 | 78796 | 78797 | 78798 | 78799 |
| | <i>euro/couple</i> | | 11,48 | 11,48 | 11,48 | 11,48 | 11,48 |

no partial packaging

Metal Line 92 and 93 are two skirting boards in aluminium, characterized by a simple design and a slightly-rounded shape, that create a perfect junction between the floor and the wall. These two elements are easy to install thanks to the interlocking system with supports, in natural aluminium or PVC, to be fixed to the wall with screws and dowels.



92/7 silver anodised aluminium + S/95 aluminium support

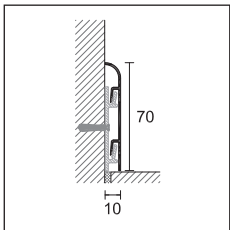

92/7

METAL LINE 92

length = 200 cm + 3 supports - pack 20 pcs

H cm

ART. finishing

7

ALUMINIUM

92/7 silver anodised
euro/m



78490
9,49

individually packed

ALUMINIUM SUPPORT

pack 100 pcs

S/95
euro/pc

78295
0,37

METAL LINE 93

length = 200 cm + 5 supports - pack 20 pcs

H cm

ART. finishing

7

9

ALUMINIUM

93/ silver anodised
euro/m



78495
10,65

78496
14,35

individually packed

FIXING CLIPS

pack 100 pcs

8608/C
euro/pack

29751
11,01

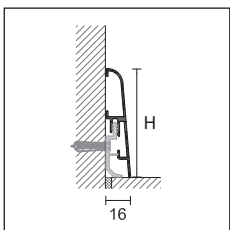

93/

Ancient grey, RAL 9003, RAL 7038, RAL 8019, RAL 9006, RAL 9007 colour-coated aluminium skirting boards are available on request, with a minimum order of 300 meters. For other colours, please contact our sales department.

For a single piece, see sales conditions on page 288



93/7 silver anodised aluminium + 8608/C fixing clips

skirting board

metal line

Metal Line 89 is a skirting board in aluminium, in different finishes, characterized by square and minimalist lines; available in different heights, it outlines the space with simplicity and elegance. Fixed on the wall through specific adhesives, it perfectly hides the perimetral expansion gap of a floating floor, as well as having a decorative role. Metal Line 89 is also available in white and black Trend Color Stone, two matt colours that perfectly combines with the most modern ceramic coverings.

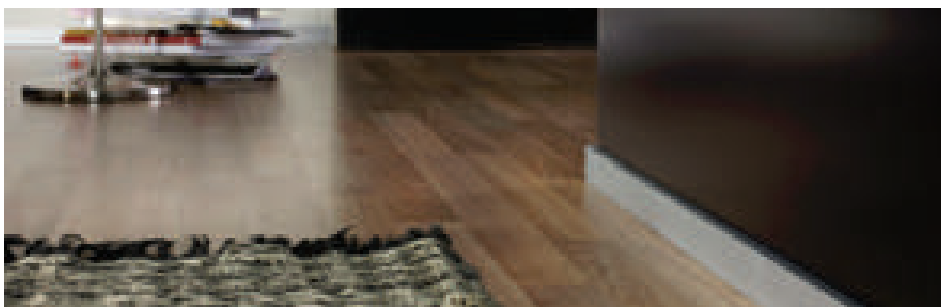

89/4 silver anodised aluminium

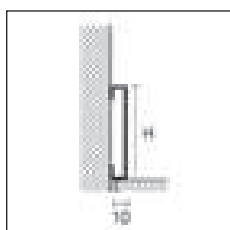

89/
89/ TM
89H/

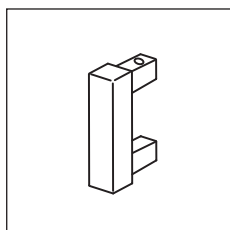

89/ EI
89/ TMEI
89H/ EI

TREND
COLOR

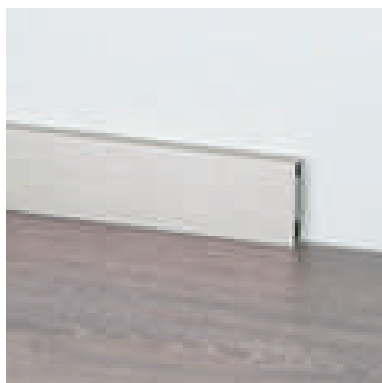

Metal Line 89 bright satin titanium



89/4 ancient grey colour-coated aluminium + 89/4EI

Complete the article code with H measure (for example 89/ for H=4 becomes 89/4).

For a single piece, see sales conditions on page 288

METAL LINE 89

length = 200 cm - pack 25 pcs

| ART. | finishing | | 4 | 6 | 8 |
|--------------------------|-----------------------------------|--|--------------|--------------|-------------|
| ALUMINIUM | | | | | |
| | silver anodised | | 78378 | 78478 | 78487 |
| | <i>euro/m</i> | | 7,93 | 8,64 | 9,24 |
| | titanium anodised | | 78521 | 78522 | - |
| | <i>euro/m</i> | | 10,56 | 11,24 | - |
| 89/ | colour-coated matt white RAL 9010 | | 78517 | 78518 | - |
| | <i>euro/m</i> | | 7,93 | 8,64 | - |
| | colour-coated ancient grey | | 78515 | 78485 | - |
| | colour-coated rust | | 78516 | - | - |
| | <i>euro/m</i> | | 11,29 | 11,69 | - |
| 89/ TM | bright satin titanium | | 78388 | 78480 | - |
| | <i>euro/m</i> | | 13,77 | 14,56 | - |
| TREND COLOR STONE | | | | | |
| 89/ | colour-coated white stone | | 78481 | - | - |
| | colour-coated black stone | | 78482 | - | - |
| | <i>euro/m</i> | | 11,29 | - | - |

COLOUR-COATED ALUMINIUM ANTIBACTERIAL

| | | | | | |
|-----------------|--|--|---|--------------|---|
| NEW 89H/ | colour-coated white RAL 9003 antibacterial | | - | 78531 | - |
| | <i>euro/m</i> | | - | 14,48 | - |

individually packed

Ancient grey, RAL 9003, RAL 7038, RAL 8019, RAL 9006, RAL 9007 colour-coated aluminium skirting boards are available on request, with a minimum order of 300 meters. For other colours, please contact our sales department.

INSIDE/OUTSIDE CORNER - RIGHT/LEFT END CAP

| ART. | finishing | | 4 | 6 | 8 |
|------------------|--|--|-------------|--------------|-------------|
| ALUMINIUM | | | | | |
| | silver anodised | | 78505 | 78506 | 78527 |
| | <i>euro/pc</i> | | 9,00 | 9,00 | 9,49 |
| | titanium anodised | | 78523 | 78524 | - |
| | <i>euro/pc</i> | | 9,00 | 9,00 | - |
| 89/ EI | colour-coated matt white RAL 9010 | | 78519 | 78520 | - |
| | <i>euro/pc</i> | | 9,00 | 9,00 | - |
| | colour-coated ancient grey | | 78512 | 78513 | - |
| | colour-coated rust | | 78514 | - | - |
| | <i>euro/pc</i> | | 9,00 | 9,00 | - |
| 89/ TMEI | bright satin titanium | | 78509 | 78510 | - |
| | <i>euro/pc</i> | | 9,00 | 9,00 | - |
| 89/ EI | colour-coated white stone | | 78507 | - | - |
| | colour-coated black stone | | 78508 | - | - |
| | <i>euro/pc</i> | | 9,00 | - | - |
| 89H/ EI | colour-coated white RAL 9003 antibacterial | | - | 78533 | - |
| | <i>euro/pc</i> | | - | 11,69 | - |

no partial packaging

In anodised aluminium, Metal Line 89 I Design is characterized by a special scratched finish and original colours that allow different chromatic combinations, created for interior designers and architects by following the latest trends of modern design.

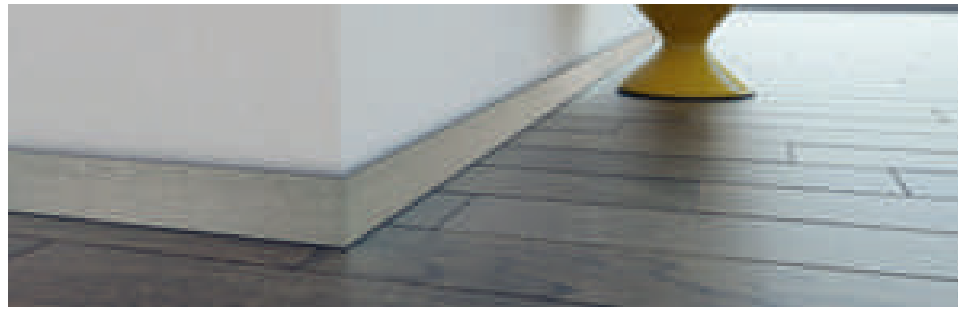

89/6 titanium anodised aluminium

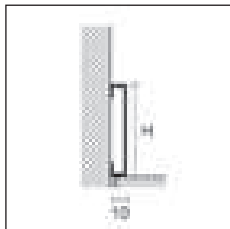

89/



89/ EI

Complete the article code with H measure (for example 89/ for H=4 becomes 89/4)

For a single piece, see sales conditions on page 288

Metal Line 89 is a skirting board in anodised aluminium with LED-strip lighting system. The light is distributed along the entire length of the profile through a diffuser element. It is possible to insert the dimmer in order to adjust the luminous intensity of the skirting board to decorate and light up the room.

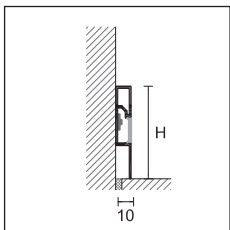

89/6L

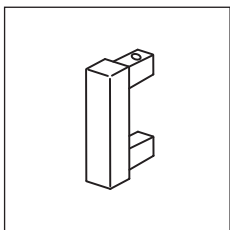

89/6EI

For the best aesthetic result and the validity of the warranty, we suggest the exclusive use of our electrical components. See page 240

For a single piece, see sales conditions on page 288

METAL LINE - I DESIGN

length = 200 cm - pack 25 pcs

| | | H | |
|---------------------------|---------------|--------------|--------------|
| ART. | finishing | 4 | 6 |
| ANODISED ALUMINIUM | | | |
| | platinum | 31400 | 31402 |
| | titanium | 31410 | 31412 |
| 89/ | brown | 31420 | 31422 |
| | dark brown | 31430 | 31432 |
| | carbon | 31440 | 31442 |
| | euro/m | 16,47 | 19,38 |

individually packed

OUTSIDE / INSIDE CORNERS / END CAPS

pack 2 pcs

| | | H | |
|---------------------------|----------------|--------------|--------------|
| ART. | finishing | 4 | 6 |
| ANODISED ALUMINIUM | | | |
| | platinum | 31450 | 31452 |
| | titanium | 31460 | 31462 |
| 89/ EI | brown | 31470 | 31472 |
| | dark brown | 31480 | 31482 |
| | carbon | 31490 | 31492 |
| | euro/pc | 20,76 | 20,76 |

no partial packaging

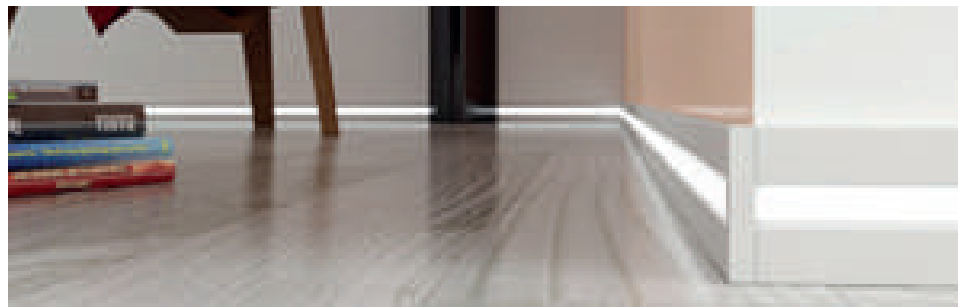

89/6L silver anodised aluminium

PROLIGHT METAL LINE 89

length = 200 cm - pack 25 pcs

| | | H cm | |
|------------------|-----------------|--------------|--|
| ART. | finishing | 6 | |
| ALUMINIUM | | | |
| 89/6L | silver anodised | 86000 | |
| | euro/m | 14,66 | |

individually packed

INSIDE/OUTSIDE CORNER - RIGHT/LEFT END CAP

pack 4 pcs

| | | H cm | |
|------------------|-----------------|--------------|--|
| ART. | finishing | 6 | |
| ALUMINIUM | | | |
| 89/6EI | silver anodised | 78506 | |
| | euro/pc | 10,28 | |

no partial packaging

skirting board

metal line

Metal Line 89/613 is a skirting board in aluminium characterized by square and minimalist lines. With a thickness of 13 mm, it perfectly hides the perimetral expansion gap of a floating floor.



89/613 silver anodised aluminium

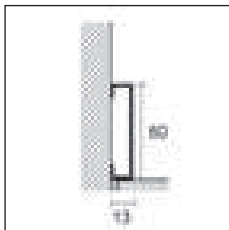

89/613

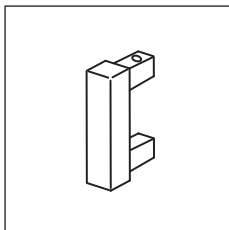

89/613 EI

METAL LINE 89/613



length = 200 cm - pack 25 pcs

H cm

ART. finishing

6

ALUMINIUM

| | | | |
|---------------|--------------------------------------|---|--------------|
| | silver anodised |  | 78486 |
| | <i>euro/m</i> | | 9,24 |
| 89/613 | colour-coated matt white RAL 9010 |  | 78488 |
| | <i>euro/m</i> | | 10,78 |

individually packed

INSIDE/OUTSIDE CORNER - RIGHT/LEFT END CAP



pack 4 pcs

H cm

ART. finishing

6

ALUMINIUM

| | | | |
|------------------|--------------------------------------|---|-------------|
| | silver anodised |  | 78525 |
| | <i>euro/pc</i> | | 9,49 |
| 89/613 EI | colour-coated matt white RAL 9010 |  | 78526 |
| | <i>euro/pc</i> | | 9,49 |

no partial packaging

Metal Line 105 is a skirting board in aluminium, characterized by square and minimalist lines. This model stands out for a simple and quick interlocking installation system with a coextruded PVC base to be fixed to the wall through screws and dowels.



Metal Line 105 silver anodised aluminium

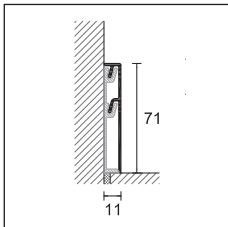

105/7
105/CB



105/71



105/7E



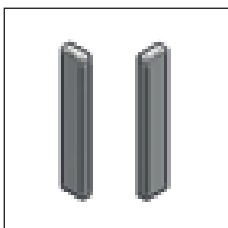

105/7G



105/7P

NEW METAL LINE

| pack 10 pcs | | | | H cm |
|------------------|-----------------|---|--------|--------------|
| ART. | finishing | length | 7 | |
| ALUMINIUM | | | | |
| 105/7 | silver anodised |  | 200 cm | 78900 |
| | silver anodised |  | 400 cm | 78910 |
| | <i>euro/m</i> | | | 17,70 |

individually packed

FIXING BASE

| pack 10 pcs | | | | H cm |
|------------------------|---------------|---|--------|-------------|
| ART. | finishing | length | 7 | |
| CO-EXTRUDED PVC | | | | |
| 105/CB | white |  | 200 cm | 78920 |
| | <i>euro/m</i> | | | 2,50 |

no partial packaging

INSIDE CORNER

| pack 4 pcs | | | | H cm |
|--------------|----------------|---|-------|-------------|
| ART. | finishing | length | 7 | |
| METAL | | | | |
| 105/7I | silver |  | 78932 | |
| | <i>euro/pc</i> | | | 6,86 |

no partial packaging

OUTSIDE CORNER

| pack 4 pcs | | | | H cm |
|--------------|----------------|---|-------|-------------|
| ART. | finishing | length | 7 | |
| METAL | | | | |
| 105/7E | silver |  | 78934 | |
| | <i>euro/pc</i> | | | 6,86 |

no partial packaging

JUNCTION

| pack 4 pcs | | | | H cm |
|--------------|----------------|---|-------|-------------|
| ART. | finishing | length | 7 | |
| METAL | | | | |
| 105/7G | silver |  | 78936 | |
| | <i>euro/pc</i> | | | 6,86 |

no partial packaging

RIGHT/LEFT END CAP

| 4 couples pack | | | | H cm |
|----------------|--------------------|---|-------|-------------|
| ART. | finishing | length | 7 | |
| METAL | | | | |
| 105/7P | silver |  | 78938 | |
| | <i>euro/couple</i> | | | 6,86 |

no partial packaging

metal line

Metal Line 87/6 and 88/6 are two flush recessed skirting boards for plaster and plasterboards. Both are composed of two separate elements: a base in natural aluminium and an insert in silver anodised or matt white colour-coated aluminium. Once installed, the skirting board integrates perfectly into the wall surface, outlining the perimeter of the space without limiting it. There are two different phases of installation: the base element must be installed when the room is still in its rough state, while the chosen insert must be put after the laying of the floor.

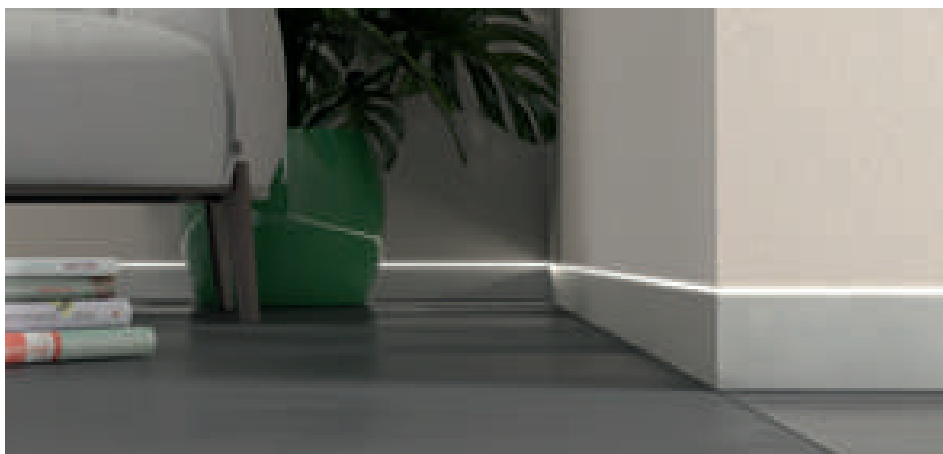

87/6 e 88/6 natural aluminium + 88/16L/A aluminium insert for LED light

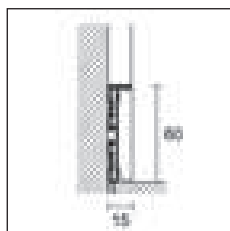

87/6 + 88/16SF
aluminium insert

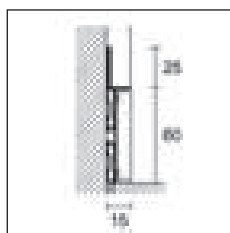

88/6 + 88/16SF
aluminium insert

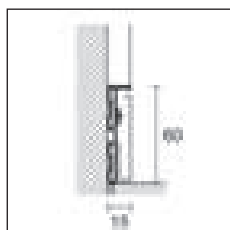

87/6 + 88/16L/A
aluminium insert for
LED light

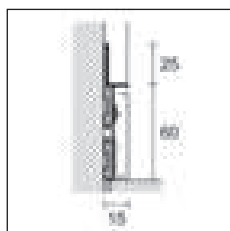

88/6 + 88/16L/A
aluminium insert for
LED light

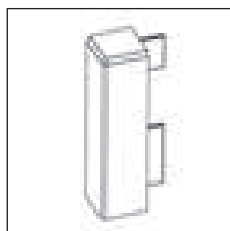

88/6E

For the best aesthetic result and the validity of the warranty, we suggest the exclusive use of our electrical components. See page 240

For a single piece, see sales conditions on page 288

METAL LINE 87 E 88

length = 200 cm - pack 20 pcs

H cm

ART. finishing

6

ALUMINIUM

| | | | |
|-------------|-----------------------------|--|--------------|
| 87/6 | natural aluminium (drilled) | | 78338 |
| | <i>euro/m</i> | | 11,41 |
| 88/6 | natural aluminium (drilled) | | 78310 |
| | <i>euro/m</i> | | 13,59 |

individually packed

ALUMINIUM INSERT

length = 200 cm - pack 20 pcs

H cm

ART. finishing

6

| | | | |
|----------------|-----------------------------------|--|-------------|
| 88/16SF | silver anodised | | 78563 |
| | matt white RAL 9010 colour-coated | | 78558 |
| | <i>euro/m</i> | | 8,80 |

individually packed

ALUMINIUM INSERT FOR LED LIGHT

length = 200 cm - pack 20 pcs

H cm

| | | | |
|-----------------|-----------------------------------|--|--------------|
| 88/16L/A | silver anodised | | 78559 |
| | matt white RAL 9010 colour-coated | | 78560 |
| | <i>euro/m</i> | | 10,83 |

adhesive - individually packed
foa electrical components, see page 59

METAL OUTSIDE CORNER

pack 4 pcs

H cm

ART. finishing

6

| | | | |
|--------------|-----------------------------------|--|--------------|
| 88/6E | silver | | 78561 |
| | matt white RAL 9010 colour-coated | | 78562 |
| | <i>euro/pc</i> | | 10,12 |

no partial packaging



88/6 natural aluminium + 88/16SF matt white aluminium insert

Prolight Metal Line SKL/2 is a skirting board in aluminium with indirect LED light. Its special section allows to create an original play of light along the wall, thus adding value to the whole surface. In addition to the silver anodised and the white stone versions, SKL/2 is available in a wide range of colours including five original cement effects, two special metal tonalities and a white characterized by an extremely solid and full colour.



SKL/2 concrete white colour-coated aluminium

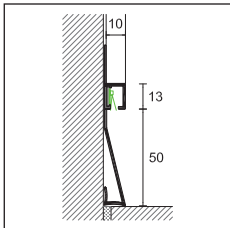

SKL/2

PROLIGHT METAL LINE S









length = 270 cm - pack 5 pcs **H**

ART. finishing **10**

ALUMINIUM

| | | | |
|--------------|-----------------|---|--------------|
| SKL/2 | silver anodised |  | 78579 |
| | euro/m | | 14,74 |

COLOUR-COATED ALUMINIUM

| | | | |
|--------------|-------------------|---|--------------|
| SKL/2 | white stone |  | 78591 |
| | concrete white |  | 78592 |
| | concrete graphite |  | 78593 |
| | concrete smoke |  | 78594 |
| | concrete mud |  | 78595 |
| | concrete sand |  | 78596 |
| | metal dark |  | 78597 |
| | metal light |  | 78598 |
| | solid white |  | 78599 |
| | euro/m | | 25,28 |

individually packed

ELECTRICAL COMPONENTS AND ACCESSORIES FOR LIGHTING

| ART. | description | |
|-------------------|--|-----------------------|
| L5/NW/65 L | spool 5 m LED strips, lateral light, neutral colour 4000 °K, 9,6W/m IP65 | 84136 |
| | euro/mt (euro/pack) | 33,13 (165,63) |

For other electrical components see page 240

Metal Line AF M Design is a skirting board in aluminium characterized by modern and minimalist lines that mark the connection between floors and coverings of same or different materials. The empty space creates an elegant shadow that highlights the two surfaces distinctly.



AF/1 silver anodised aluminium

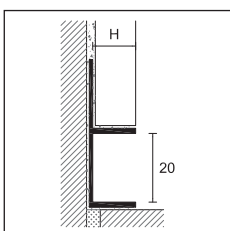



AF/1

METAL LINE AF - M DESIGN

length = 270 cm - pack 10 pcs **H**

ART. finishing **6** **10** **12,5**

ALUMINIUM

| | | | | | |
|-------------|---------------------------------------|---|--------------|--------------|--------------|
| | silver anodised |  | 13198 | 13199 | 13200 |
| | euro/m | | 8,34 | 8,34 | 8,34 |
| AF/1 | titanium anodised |  | 13201 | 13203 | 13202 |
| | colour-coated polished white RAL 9010 |  | 13196 | 13197 | 13204 |
| | euro/m | | 12,16 | 12,16 | 12,16 |

individually packed

For a single piece, see sales conditions on page 288

metal line

Metal Line 100 is an anodized aluminium baseboard available in two heights and suitable for application of plasterboard, directly into the wall. The profile is easy to apply through the use of appropriate adhesives.



100/70 silver anodised aluminium

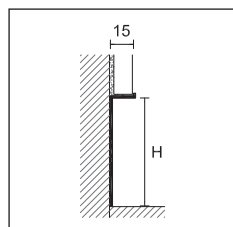

100/

METAL LINE 100

length = 200 cm - pack 20 pcs

H mm

| ART. | finishing | 40 | 70 |
|------|-----------|----|----|
|------|-----------|----|----|

ALUMINIUM

| | | | |
|------|-----------------|-------|-------|
| 100/ | silver anodised | 78277 | 78279 |
| | euro/m | 7,93 | 11,19 |

individually packed

Metal Line 101, ideal for plaster and made of anodized aluminium, is suitable for application directly on the rough wall. The profile is applied using special adhesives, before making the plastering of the wall.



101/74 silver anodised aluminium

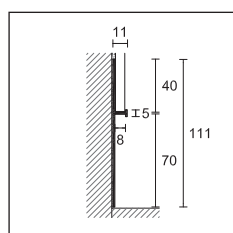

101/74

METAL LINE 101

length = 200 cm - pack 20 pcs

H mm

| ART. | finishing | 70 |
|------|-----------|----|
|------|-----------|----|

ALUMINIUM

| | | |
|--------|-----------------|-------|
| 101/74 | silver anodised | 78281 |
| | euro/m | 15,17 |

individually packed

MS POLYMER-BASED ADHESIVE FOR SKIRTING BOARDS

pack 24 pcs - quantity 290 ml

ART.

| | |
|-------|-------|
| PP/96 | 78301 |
|-------|-------|

| | |
|---------|-------|
| euro/pc | 18,81 |
|---------|-------|

output 10/15 m for cartridge

Ancient grey, RAL 9003, RAL 7038, RAL 8019, RAL 9006, RAL 9007 colour-coated aluminium skirting boards are available on request, with a minimum order of 300 meters.

For other colours, please contact our sales department.

For a single piece, see sales conditions on page 288

Metal Line 95 is a skirting board in aluminium, available in two different heights, that allows to hide service cables (telephone, computers, TV etc.). This model is characterized by a simple and quick interlocking installation system with natural aluminium supports that, fixed to the wall with screws and dowels, facilitate the removal for the maintenance of the service cables.



95/7 silver anodised aluminium

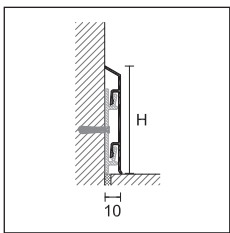

95/

METAL LINE 95

| pack 25 pcs | | length | H cm | |
|------------------|-----------------|---------------------|-------------|--------------|
| ART. | finishing | | 7 | 10 |
| ALUMINIUM | | | | |
| 95/ SF | silver anodised | 200 cm + 3 supports | 78160 | 78175 |
| | | 400 cm + 6 supports | 78161 | 78176 |
| | | <i>euro/m</i> | 9,31 | 13,06 |

individually packed - length 400 cm pack 10 pcs

ALUMINIUM SUPPORT

| pack 100 pcs | | | H cm | |
|--------------|-----------|----------------|-------------|----|
| ART. | finishing | | 7 | 10 |
| S/95 | | | 78295 | |
| | | <i>euro/pc</i> | 0,37 | |

no partial packaging

INSIDE CORNER IN POLYPROPYLENE

| pack 4 pcs | | | H cm | |
|------------|-----------------|----------------|-------------|-------------|
| ART. | finishing | | 7 | 10 |
| 95/ I | silver anodised | | 78201 | 78206 |
| | | <i>euro/pc</i> | 3,31 | 3,31 |

no partial packaging

OUTSIDE CORNER IN POLYPROPYLENE

| pack 4 pcs | | | H cm | |
|------------|-----------------|----------------|-------------|-------------|
| ART. | finishing | | 7 | 10 |
| 95/ E | silver anodised | | 78200 | 78205 |
| | | <i>euro/pc</i> | 3,31 | 3,31 |

no partial packaging

JUNCTION IN POLYPROPYLENE

| pack 4 pcs | | | H cm | |
|------------|-----------------|----------------|-------------|-------------|
| ART. | finishing | | 7 | 10 |
| 95/ G | silver anodised | | 78202 | 78207 |
| | | <i>euro/pc</i> | 3,31 | 3,31 |

no partial packaging

RIGHT/LEFT END CAPS IN POLYPROPYLENE

| 4 couples pack | | | H cm | |
|----------------|-----------------|--------------------|-------------|-------------|
| ART. | finishing | | 7 | 10 |
| 95/ P | silver anodised | | 78203 | 78208 |
| | | <i>euro/couple</i> | 3,31 | 3,31 |

no partial packaging



95/7 silver anodised aluminium + S/95 aluminium support

Ancient grey, RAL 9003, RAL 7038, RAL 8019, RAL 9006, RAL 9007 colour-coated aluminium skirting boards are available on request, with a minimum order of 300 meters. For other colours, please contact our sales department.

Complete the article code with H measure (for example 95/SF for H=7 becomes 95/7SF)

For a single piece, see sales conditions on page 288

metal line

Metal Line 98 is a skirting board in aluminium characterized by round and soft lines and a thickness that allows the housing of service cables (telephone, computer, TV, etc.). A simple and functional interlocking installation system with natural aluminium supports to be fixed to the wall provides easy access to the cables for their maintenance.



98/7SF silver anodised aluminium

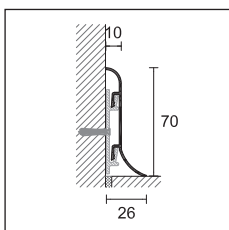

98/7SF



98/7SF silver anodised aluminium + S/95 aluminium support

METAL LINE 98

pack 20 pcs

H cm

ART. finishing length 7

ALUMINIUM

| | | | |
|---------------|-----------------|---------------------|--------------|
| 98/7SF | silver anodised | 200 cm + 3 supports | 78040 |
| | | 400 cm + 6 supports | 78041 |
| <i>euro/m</i> | | | 12,54 |

individually packed - length 400 cm pack 10 pcs

ALUMINIUM SUPPORT

pack 100 pcs

| | |
|----------------|-------------|
| S/95 | 78295 |
| <i>euro/pc</i> | 0,37 |

no partial packaging

INSIDE CORNER IN POLYPROPYLENE

pack 4 pcs

H cm

| | |
|-----------------------|-------------|
| ART. finishing | 7 |
| 98/7I silver anodised | 78221 |
| <i>euro/pc</i> | 3,31 |

no partial packaging

OUTSIDE CORNER IN POLYPROPYLENE

pack 4 pcs

H cm

| | |
|-----------------------|-------------|
| ART. finishing | 7 |
| 98/7E silver anodised | 78220 |
| <i>euro/pc</i> | 3,31 |

no partial packaging

JUNCTION IN POLYPROPYLENE

pack 4 pcs

H cm

| | |
|-----------------------|-------------|
| ART. finishing | 7 |
| 98/7G silver anodised | 78222 |
| <i>euro/pc</i> | 3,31 |

no partial packaging

RIGHT/LEFT END CAPS IN POLYPROPYLENE

4 couples pack

H cm

| | |
|-----------------------|-------------|
| ART. finishing | 7 |
| 98/7P silver anodised | 78223 |
| <i>euro/couple</i> | 3,31 |

no partial packaging

Ancient grey, RAL 9003, RAL 7038, RAL 8019, RAL 9006, RAL 9007 colour-coated aluminium skirting boards are available on request, with a minimum order of 300 meters. For other colours, please contact our sales department.

For a single piece, see sales conditions on page 288

Metal Line 97/4 is a 4 cm high aluminium skirting board that allows the housing of service cables (telephone, computer, TV, etc.). Thanks to a simple interlocking installation system with harmonic stainless steel clips to be fixed to the wall with screws and dowels, it combines ease and speed of installation with easy access to the cables for their maintenance.

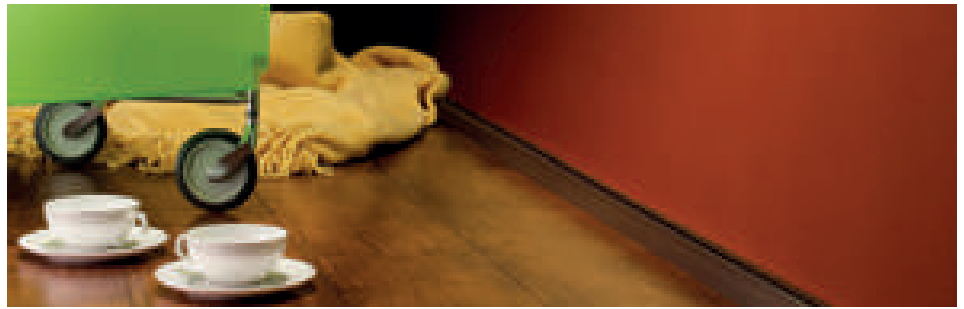

97/4TMSF silver anodised aluminium

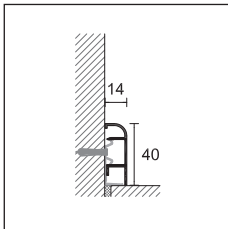

97/



97/4SF silver anodised aluminium + 8602/C fixing clip

METAL LINE 97

| | | |
|-------------------------------|------------------|-------------|
| length = 200 cm - pack 25 pcs | | H cm |
| ART. | finishing | 4 |
| ALUMINIUM | | |
| 97/4SF + 5 clips | silver anodised | 78000 |
| | <i>euro/m</i> | 7,95 |

individually packed

FIXING CLIPS

| | | |
|-----------------------------------|---------------------|-------------|
| 10 blister packs / 20 pcs/blister | | |
| 8602/C | | 29750 |
| | <i>euro/blister</i> | 5,93 |

no partial packaging

INSIDE CORNER IN POLYPROPYLENE

| | | |
|-------------|------------------|-------------|
| pack 4 pcs | | H cm |
| ART. | finishing | 4 |
| 97/4I | silver anodised | 78002 |
| | <i>euro/pc</i> | 4,31 |

no partial packaging

OUTSIDE CORNER IN POLYPROPYLENE

| | | |
|-------------|------------------|-------------|
| pack 4 pcs | | H cm |
| ART. | finishing | 4 |
| 97/4E | silver anodised | 78001 |
| | <i>euro/pc</i> | 4,31 |

no partial packaging

JUNCTION IN POLYPROPYLENE

| | | |
|-------------|------------------|-------------|
| pack 4 pcs | | H cm |
| ART. | finishing | 4 |
| 97/4G | silver anodised | 78003 |
| | <i>euro/pc</i> | 4,31 |

no partial packaging

RIGHT/LEFT END CAPS IN POLYPROPYLENE

| | | |
|----------------|--------------------|-------------|
| 4 couples pack | | H cm |
| ART. | finishing | 4 |
| 97/4P | silver anodised | 78004 |
| | <i>euro/couple</i> | 4,31 |

no partial packaging

Ancient grey, RAL 9003, RAL 7038, RAL 8019, RAL 9006, RAL 9007 colour-coated aluminium skirting boards are available on request, with a minimum order of 300 meters. For other colours, please contact our sales department.

For a single piece, see sales conditions on page 288

skirting board

metal line

Metal Line 97/7 is a 7 cm high aluminium skirting board with a simple and linear design. Easy and quick to install thanks to an interlocking installation system with natural aluminium supports to be fixed to the wall with screws and dowels, it provides easy access to the cables for their maintenance.

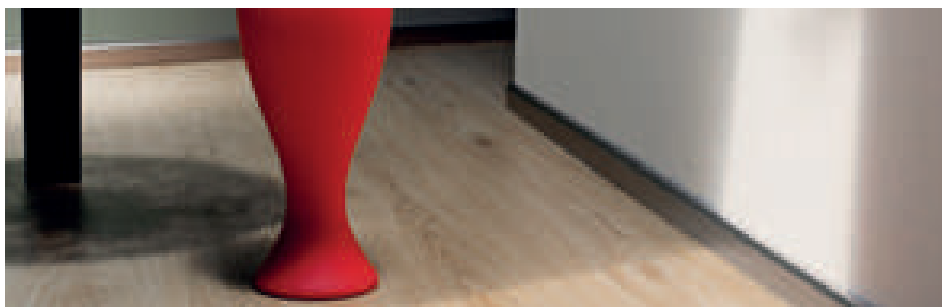

97/7SF silver anodised aluminium

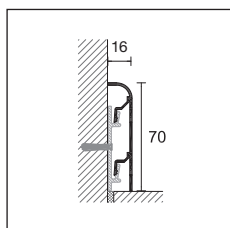

97/7SF

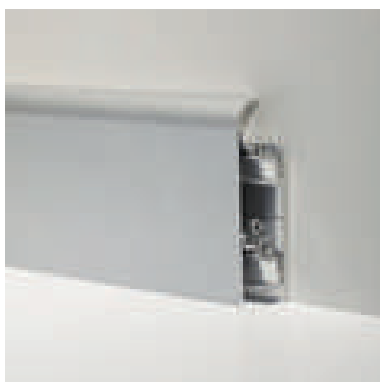

97/7SF silver anodised aluminium
+ S/95 aluminium support

METAL LINE 97

length = 200 cm - pack 20 pcs

H cm

ART. finishing

7

ALUMINIUM

97/7SF +
3 supports
silver anodised
euro/m

78005

13,43

individually packed

ALUMINIUM SUPPORT

pack 100 pcs

S/95

78295

euro/pc

0,37

no partial packaging

INSIDE CORNER IN POLYPROPYLENE

pack 4 pcs

H cm

ART. finishing

7

97/7I silver anodised
euro/pc

78157

3,31

no partial packaging

OUTSIDE CORNER IN POLYPROPYLENE

pack 4 pcs

H cm

ART. finishing

7

97/7E silver anodised
euro/pc

78156

3,31

no partial packaging

JUNCTION IN POLYPROPYLENE

pack 4 pcs

H cm

ART. finishing

7

97/7G silver anodised
euro/pc

78158

3,31

no partial packaging

RIGHT/LEFT END CAPS IN POLYPROPYLENE

4 couples pack

H cm

ART. finishing

7

97/7P silver anodised
euro/couple

78159

3,31

no partial packaging

Ancient grey, RAL 9003, RAL 7038, RAL 8019, RAL 9006, RAL 9007 colour-coated aluminium skirting boards are available on request, with a minimum order of 300 meters.

For other colours, please contact our sales department.

For a single piece, see sales conditions on page 288

Metal Line 97/8 is a 8 cm high aluminium skirting board specially designed for housing cables thanks to the specific PVC cable trunking that, fixed to the wall with screws and dowels, also acts as support of the skirting board. It is particularly suitable for renovations as it avoids making new tracks for the passage of cables. It is also easy and quick to install only using natural aluminium supports that, fixed to the wall with screws and dowels, make the access to service cables easy.



97/8SF silver anodised aluminium

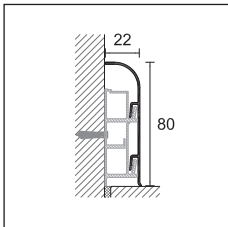

97/8SF



97/8SF silver anodised aluminium
+ 97/8CB white pvc trunking

METAL LINE 97

| pack 20 pcs | | | H cm |
|------------------|-----------------|---------------------|--------------|
| ART. | finishing | length | 8 |
| ALUMINIUM | | | |
| 97/8SF | silver anodised | 200 cm + 3 supports | 78010 |
| | | 400 cm + 6 supports | 78011 |
| | <i>euro/m</i> | | 13,99 |

individually packed - length 400 cm pack 10 pcs

WHITE PVC TRUNKING

| length 200 cm - pack 20 pcs | | |
|-----------------------------|--------------------------|-------------|
| 97/8CB | <input type="checkbox"/> | 78290 |
| <i>euro/m</i> | | 4,96 |

no partial packaging

ALUMINIUM SUPPORT

| pack 100 pcs | | |
|----------------|--|-------------|
| S/97 | | 78299 |
| <i>euro/pc</i> | | 0,66 |

no partial packaging

INSIDE CORNER IN POLYPROPYLENE

| pack 4 pcs | | | H cm |
|------------|-----------------|--|-------------|
| ART. | finishing | | 8 |
| 97/8I | silver anodised | | 78211 |
| | <i>euro/pc</i> | | 3,31 |

no partial packaging

OUTSIDE CORNER IN POLYPROPYLENE

| pack 4 pcs | | | H cm |
|------------|-----------------|--|-------------|
| ART. | finishing | | 8 |
| 97/8E | silver anodised | | 78210 |
| | <i>euro/pc</i> | | 3,31 |

no partial packaging

JUNCTION IN POLYPROPYLENE

| pack 4 pcs | | | H cm |
|------------|-----------------|--|-------------|
| ART. | finishing | | 8 |
| 97/8G | silver anodised | | 78212 |
| | <i>euro/pc</i> | | 3,31 |

no partial packaging

RIGHT/LEFT END CAPS IN POLYPROPYLENE

| 4 couples pack | | | H cm |
|----------------|--------------------|--|-------------|
| ART. | finishing | | 8 |
| 97/8P | silver anodised | | 78213 |
| | <i>euro/couple</i> | | 3,31 |

no partial packaging

Ancient grey, RAL 9003, RAL 7038, RAL 8019, RAL 9006, RAL 9007 colour-coated aluminium skirting boards are available on request, with a minimum order of 300 meters. For other colours, please contact our sales department.

For a single piece, see sales conditions on page 288





PVC line skirting board

A range of PVC skirting boards to meet all technical and aesthetical needs. Suitable for both professional and DIY use, some models can be customised using digital printing technology PDS.

skirting board

pvc line

PVC Line 8605 and 8606 are two skirting boards in co-extruded PVC, characterized by a rounded shape and a 70-mm height. Both are composed of a core in foam PVC and a visible surface in coloured rigid PVC to guarantee the best aesthetic result and colour uniformity. 8605 can also be covered with Alcrom® Plus film and can be further customized thanks to the digital printing technology Profilpas Digital System. 8605 and 8606 can be fixed to the wall with adhesive (PP/96) or nails. Moreover, they do not absorb water and are resistant to impact, wear and tear, UV rays and the products normally used for cleaning floors and wall coverings.

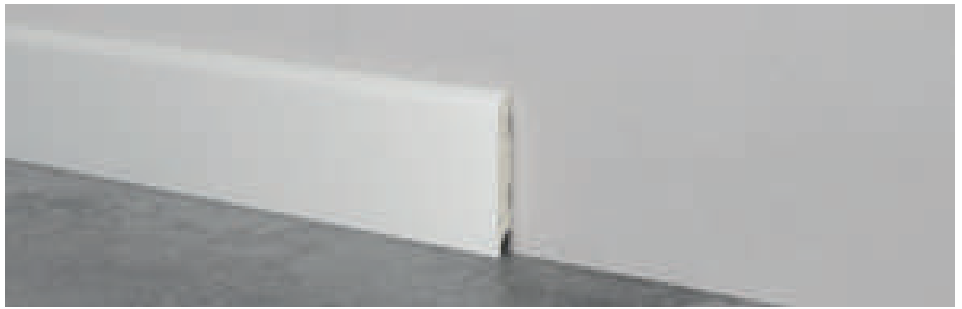

8606 white RAL 9003 co-extruded PVC

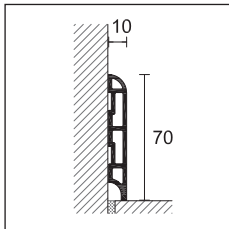

8605

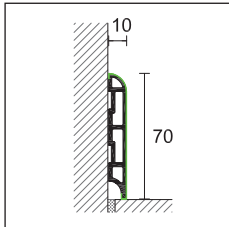

8605 covered with Alcrom® Plus film



8605 foam PVC covered with Alcrom® Plus film

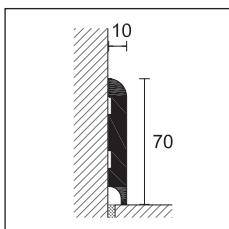

8606

MS polymer-based adhesive for skirting boards see page 266

For customizations with decors that are not in our database, there is an extra of 165 € for decor.

For a single piece, see sales conditions on page 288

NEW PVC LINE

length 250 cm - pack 20 pcs - H = 70 mm

CO-EXTRUDED PVC (FOAM PVC + RIGID PVC)

ART.

| | | | | | | |
|------|--------------------------|----------------|-------|--------------------------|----------------|-------|
| 8605 | <input type="checkbox"/> | white RAL 9003 | 29175 | <input type="checkbox"/> | black RAL 9004 | 29176 |
| | <input type="checkbox"/> | white RAL 9010 | 29177 | | | |

euro/m

2,94

| | | | |
|------|--------------------------|--------|-------|
| 8605 | <input type="checkbox"/> | silver | 29178 |
|------|--------------------------|--------|-------|

euro/m

no partial packaging

PVC LINE

length 250 cm - pack 20 pcs - H = 70 mm

CO-EXTRUDED PVC (FOAM PVC + RIGID PVC) COVERED WITH ALCROM® PLUS FILM

ART.

decors

| | | | |
|------|--------------------------|----------------------------|-------|
| 8605 | <input type="checkbox"/> | 96 white RAL 9010 embossed | 29030 |
| | <input type="checkbox"/> | 97 black RAL 9005 embossed | 29031 |

euro/m

3,72

| | | | |
|------|--------------------------|-----------------|-------|
| 8605 | <input type="checkbox"/> | 99 satin silver | 29035 |
| | <input type="checkbox"/> | 100 satin steel | 29036 |

euro/m

5,23

no partial packaging

PVC LINE

length = 250 cm - pack 20 pcs - H = 70 mm

CO-EXTRUDED PVC (FOAM PVC + RIGID PVC) COVERED WITH ALCROM® PLUS FILM

| ART. | decors | | decors | | decors | | decors | |
|------|--------|-------|--------|-------|--------|-------|--------|-------|
| 8605 | 02 | 29000 | 41 | 29012 | 1006 | 29102 | 1060 | 29120 |
| | 08 | 29001 | 44 | 29013 | 1009 | 29103 | 1063 | 29121 |
| | 09 | 29002 | 47 | 29033 | 1012 | 29104 | 1066 | 29122 |
| | 10 | 29003 | 48 | 29015 | 1021 | 29107 | 1069 | 29123 |
| | 11 | 29004 | 65 | 29018 | 1024 | 29108 | 1081 | 29127 |
| | 12 | 29005 | 76 | 29020 | 1030 | 29110 | 1084 | 29128 |
| | 20 | 29006 | 77 | 29021 | 1033 | 29111 | 1087 | 29129 |
| | 25 | 29032 | 78 | 29022 | 1036 | 29112 | 1090 | 29130 |
| | 32 | 29007 | 80 | 29023 | 1042 | 29114 | 1105 | 29135 |
| | 34 | 29008 | 81 | 29024 | 1045 | 29115 | 1108 | 29136 |
| | 35 | 29009 | 92 | 29026 | 1051 | 29117 | 1111 | 29137 |
| | 36 | 29010 | 95 | 29029 | 1054 | 29118 | | |
| | 40 | 29011 | 1003 | 29101 | 1057 | 29119 | | |

euro/m

3,72

no partial packaging - 8605 can be covered with customised Alcrom® Plus film on request, with a minimum order of 500 meters €/m 3,72

NEW PVC LINE

length 250 cm - pack 20 pcs - H = 70 mm

CO-EXTRUDED PVC (FOAM PVC + RIGID PVC)

ART.

| | | | | | | |
|------|--------------------------|----------------|-------|--------------------------|----------------|-------|
| 8606 | <input type="checkbox"/> | white RAL 9003 | 29227 | <input type="checkbox"/> | black RAL 9004 | 29228 |
| | <input type="checkbox"/> | white RAL 9010 | 29229 | | | |

euro/m

4,41

| | | | |
|------|--------------------------|--------|-------|
| 8606 | <input type="checkbox"/> | silver | 29230 |
|------|--------------------------|--------|-------|

euro/m

no partial packaging - 8606 can be covered with customised Alcrom® Plus film on request, with a minimum order of 500 meters €/m 5,04

PVC Line 8608 is a skirting board in PVC foam, characterized by a round shape and covered with Alcrom® Plus film. Available in several decors, it can be further customized thanks to the digital printing technology Profilpas Digital System. 8608 can be fixed to the wall with adhesive (PP/96 or similar), nails or special fixing clips. PVC does not absorb water, does not contain formaldehyde, is resistant to shocks, wear (certificate AC3), UV rays and the most common cleaning products for floors and wall coverings.

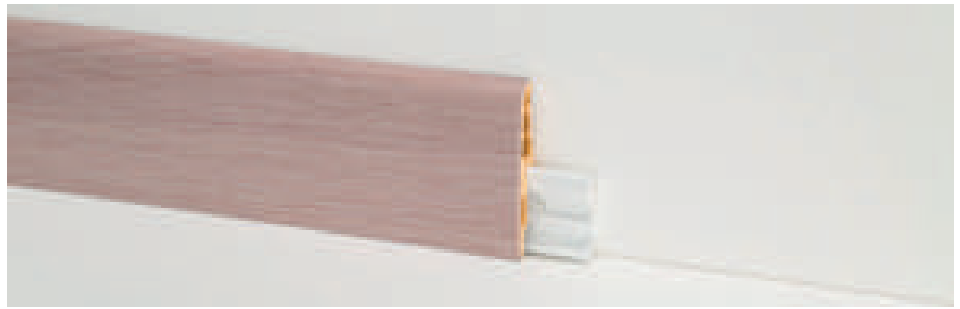

8608 foam PVC covered with Alcrom® Plus film + 8608/C

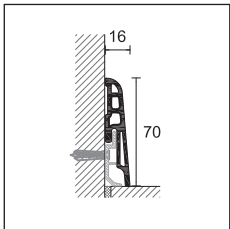

8608

PVC LINE

length = 250 cm - pack 20 pcs

FOAM PVC COVERED WITH ALCROM® PLUS FILM

H = 70 mm

| ART. | decors | | decors | | decors | |
|---------------|--------|-------|-----------------|-------|-------------------------------|-------|
| | 02 | 29040 | 32 | 29047 | 77 | 29061 |
| | 05 | 29075 | 34 | 29048 | 78 | 29062 |
| | 08 | 29041 | 35 | 29049 | 80 | 29063 |
| | 10 | 29043 | 36 | 29050 | 81 | 29064 |
| | 11 | 29044 | 39 | 29080 | 89 | 29081 |
| 8608 | 12 | 29045 | 40 | 29051 | 91 | 29082 |
| | 14 | 29076 | 41 | 29052 | 92 | 29066 |
| | 19 | 29077 | 44 | 29053 | 95 | 29069 |
| | 20 | 29046 | 47 | 29073 | 96 white RAL 9010 embossed | 29070 |
| | 26 | 29078 | 65 | 29058 | 97 black RAL 9005 embossed | 29071 |
| | 31 | 29079 | 76 | 29060 | | |
| euro/m | | | | | 3,89 | |
| 8608 | | | 99 satin silver | 29083 | | |
| | | | 100 satin steel | 29084 | | |
| euro/m | | | | | 5,45 | |

no partial packaging

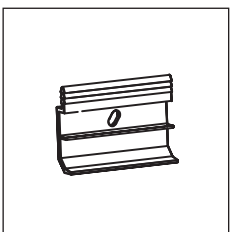

8608/C

FIXING CLIPS FOR ART. 8608

pack of 100 pcs

| | |
|------------------|--------------|
| 8608/C | 29751 |
| euro/pack | 11,01 |



8608 foam PVC covered with Alcrom® Plus film Plus 99 satin silver

MS polymer-based adhesive for skirting boards see page 266

Customized PDS decors on request for 8608 with a minimum order of 500 meters.

For customizations with decors that are not in our database, there is an extra of 165 € for decor.

For a single piece, see sales conditions on page 288

skirting board

pvc line

PVC Line 8615 and 8616 are two skirting boards in co-extruded PVC, characterized by a square shape and a 70-mm height. Both are composed of a core in foam PVC and a visible surface in coloured rigid PVC to guarantee the best aesthetic result and colour uniformity.

They can also be covered with Alcrom® Plus film and can be further customized thanks to the digital printing technology Profilpas Digital System.

8615 and 8616 can be fixed to the wall with adhesive (PP/96) or nails. Moreover, they do not absorb water and are resistant to impact, wear and tear, UV rays and the products normally used for cleaning floors and wall coverings.



8615 silver co-extruded PVC

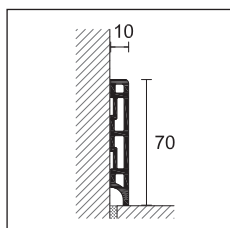

8615

NEW PVC LINE

length 250 cm - pack 20 pcs - H = 70 mm

CO-EXTRUDED PVC (FOAM PVC + RIGID PVC)

ART.

| | | | | | | |
|---------------|-------------------------------------|----------------|-------|-------------------------------------|----------------|-------|
| 8615 | <input type="checkbox"/> | white RAL 9003 | 29353 | <input checked="" type="checkbox"/> | black RAL 9004 | 29354 |
| | <input type="checkbox"/> | white RAL 9010 | 29355 | | | |
| euro/m | | | | | 2,94 | |
| 8615 | <input checked="" type="checkbox"/> | silver | 29356 | | | |
| euro/m | | | | | | |

no partial packaging

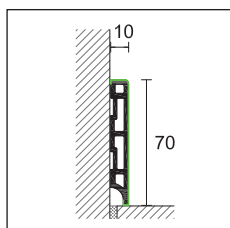

8615 decors with film Alcrom® Plus

NEW PVC LINE

length 250 cm - pack 20 pcs - H = 70 mm

CO-EXTRUDED PVC (FOAM PVC + RIGID PVC) COVERED WITH ALCROM® PLUS FILM

ART.

decors

| | | | | | |
|---------------|-------------------------------------|----------------------------|-------|--|-------------|
| 8615 | <input type="checkbox"/> | 96 white RAL 9010 embossed | 29357 | | |
| | <input checked="" type="checkbox"/> | 97 black RAL 9005 embossed | 29358 | | |
| euro/m | | | | | 3,72 |

no partial packaging

8615 can be covered with customised Alcrom® Plus film on request, with a minimum order of 500 meters €/m 3,72

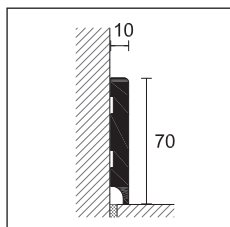

8616

NEW PVC LINE

length 250 cm - pack 20 pcs - H = 70 mm

CO-EXTRUDED PVC (FOAM PVC + RIGID PVC)

ART.

| | | | | | | |
|---------------|-------------------------------------|----------------|-------|-------------------------------------|----------------|-------|
| 8616 | <input type="checkbox"/> | white RAL 9003 | 29495 | <input checked="" type="checkbox"/> | black RAL 9004 | 29496 |
| | | | | | | |
| euro/m | | | | | 4,41 | |
| 8616 | <input checked="" type="checkbox"/> | silver | 29498 | | | |
| euro/m | | | | | | |

no partial packaging

8616 can be covered with customised Alcrom® Plus film on request, with a minimum order of 500 meters €/m 5,04



8616 black RAL 9004 co-extruded PVC

MS polymer-based adhesive for skirting boards see page 266

For customizations with decors that are not in our database, there is an extra of 165 € for decor.

For a single piece, see sales conditions on page 288



8615 white RAL 9003 co-extruded PVC

PVC Line 8613 is a foam PVC skirting board covered with Alcrom® Plus film, suitable for wooden floors. It can be fixed to the wall with adhesive (PP/96) or fixing clip 8608/C.



8613 foam PVC covered with Alcrom® Plus film - decor 96

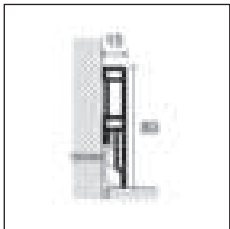

8613

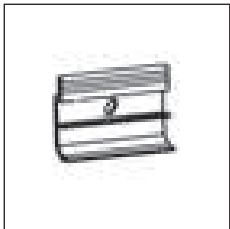

8608/C

PVC LINE

length = 250 cm - pack 20 pcs

FOAM PVC COVERED WITH ALCROM® PLUS FILM

H = 80 mm

| ART. | decors | | decors | |
|-------------|-------------------------------|-------------|-------------|-------|
| | 05 | 30060 | 580 | 30076 |
| | 08 | 30061 | 1202 | 30078 |
| | 12 | 30062 | 1203 | 30079 |
| | 13 | 30063 | 1204 | 30080 |
| | 14 | 30064 | 1205 | 30081 |
| | 19 | 30065 | 1206 | 30082 |
| | 26 | 30066 | 1207 | 30083 |
| | 31 | 30094 | 1208 | 30084 |
| 8613 | 32 | 30067 | 1209 | 30085 |
| | 36 | 30068 | 1210 | 30086 |
| | 39 | 30069 | 1211 | 30087 |
| | 40 | 30070 | 1212 | 30088 |
| | 41 | 30071 | 1213 | 30089 |
| | 77 | 30072 | 1214 | 30090 |
| | 89 | 30073 | 1215 | 30091 |
| | 91 | 30074 | 1216 | 30092 |
| | 93 | 30075 | 1217 | 30093 |
| | 96 white RAL 9010 embossed | 29971 | | |
| | euro/m | | 4,80 | |
| 8613 | 99 satin silver | 29974 | | |
| | 100 satin steel | 29975 | | |
| | euro/m | 6,34 | | |

no partial packaging

FIXING CLIPS FOR ART. 8613

pack of 100 pcs

| | | |
|---------------|------------------|--------------|
| | | 29751 |
| 8608/C | euro/pack | 11,01 |

no partial packaging



8613 covered with Alcrom® Plus film - decor 100 satin steel

Customized PDS decors on request for 8613 with a minimum order of 500 meters.

For customizations with decors that are not in our database, there is an extra of 165 € for decor.

For a single piece, see sales conditions on page 288

skirting board

pvc line

PVC Line 8612 is a foam PVC skirting board covered with Alcrom® Plus film, suitable for both ceramic and LVT floors. It can be fixed to the wall with adhesive (PP/96).



8612/10 foam PVC covered with Alcrom® Plus film - decor 96

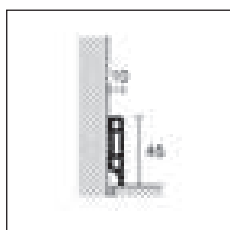

8612/10

PVC LINE

length 250 cm - pack 20 pcs

FOAM PVC COVERED WITH ALCROM® PLUS FILM

H = 45 mm

| ART. | decors | | |
|----------------|----------------------------|-------------------------------------|-------------|
| | 96 white RAL 9010 embossed | <input type="checkbox"/> | 29970 |
| | <i>euro/m</i> | | 3,72 |
| 8612/10 | 99 satin silver | <input checked="" type="checkbox"/> | 29968 |
| | 100 satin steel | <input checked="" type="checkbox"/> | 29967 |
| | <i>euro/m</i> | | 5,23 |

no partial packaging

PVC Line 8614 is a foam PVC skirting board covered with white Alcrom® Plus film, suitable in case of refurbishment if you want to cover the old skirting boards that are still fixed to the wall. It can be fixed to the old skirting board with adhesive (PP/96).



8614 foam PVC covered with Alcrom® Plus film - decor 96

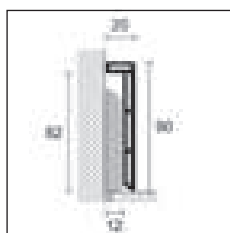

8614

PVC LINE

length = 250 cm - pack 20 pcs

FOAM PVC COVERED WITH ALCROM® PLUS FILM

H = 90 mm

| ART. | decors | | |
|-------------|----------------------------|--------------------------|-------------|
| | 96 white RAL 9010 embossed | <input type="checkbox"/> | 29972 |
| 8614 | <i>euro/m</i> | | 5,18 |

no partial packaging

8612 and 8614 can be covered with customised Alcrom® Plus film on request, with a minimum order of 500 meters.

For customizations with decors that are not in our database, there is an extra of 165 € for decor.

For a single piece, see sales conditions on page 288

PVC Line 8600 is a foam PVC skirting board, particularly suitable for DIY installations thanks to its quick and easy application. It is available in different colours and can be fixed with adhesive (PP/96).

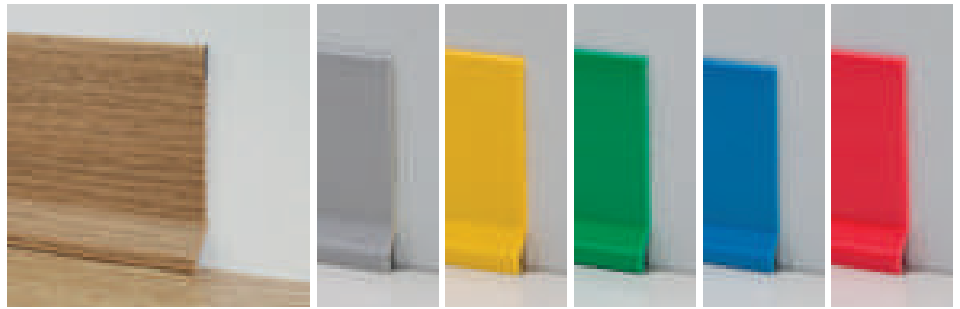

8600 foam PVC decor 532

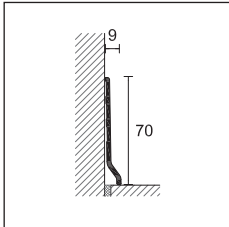

8600

PVC LINE

length 200 cm - pack 20/100 pcs

FOAM PVC

H = 70 mm

| ART. | decors | | decors | | decors | | decors | |
|--------------|---------------|-------|----------------|-------|-------------|-------|------------|-------|
| | 518 | 29762 | 536 | 29782 | giallo 561 | 29802 | silver 559 | 29800 |
| | 520 | 29764 | 540 | 29784 | verde 562 | 29804 | | |
| | 524 | 29766 | 542 | 29786 | azzurro 563 | 29801 | | |
| | 525 | 29768 | 544 | 29788 | rosso 564 | 29803 | | |
| 8600 | 528 | 29770 | 545 | 29790 | | | | |
| | 530 | 29772 | white 555 | 29792 | | | | |
| | 531 | 29774 | light grey 556 | 29794 | | | | |
| | 532 | 29776 | black 557 | 29796 | | | | |
| | 533 | 29778 | anthracite 558 | 29798 | | | | |
| | 534 | 29780 | | | | | | |
| pack 20 pcs | | | | | | | | |
| | <i>euro/m</i> | | 1,42 | | 1,48 | | 1,68 | |
| pack 100 pcs | | | | | | | | |
| | <i>euro/m</i> | | 1,14 | | 1,19 | | 1,39 | |

no partial packaging

external corner profiles available in the same decors, see page 45

PVC Line 8181 is a 70 mm high skirting board in plastic-coated PVC, characterized by a special shape that makes it suitable for installation on curved walls. 8181 is particularly suitable for DIY installation, thanks to its quick and easy application. Available in different colours, it can be fixed to the wall with adhesive (PP/96).



PVC Line 8181 white PVC

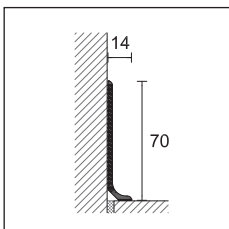

8181

NEW PVC LINE

length = 250 cm - pack 12 pcs

PLASTIC-COATED PVC

H = 70 mm

| ART. | decors | | |
|------|---------------|--|-------|
| | white | | 19216 |
| | grey | | 19217 |
| 8181 | black | | 19218 |
| | <i>euro/m</i> | | 4,62 |

no partial packaging

To order 8600 in pack of 100 pcs mark /100 after the article code (for example 29778 becomes 29778/100).

For a single piece, see sales conditions on page 288

skirting board

pvc line

PVC Line 8596 and 8598 are two impact-resistant skirting boards in foam PVC. The upper part resting on the wall and the lower part resting on the floor are in soft material and allow a perfect adhesion even to surfaces that are not perfectly planar, maintaining speed and simplicity of application. They are available in different colours and can be fixed with adhesive (PP/96).



8596 Foam PVC decor 545

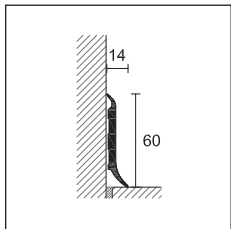

8596

PVC LINE

length = 250 cm - pack 40 pcs

FOAM PVC

H = 60 mm

| ART. | decors | | decors | | decors | |
|------|--------|-------|--------|-------|----------------|-------|
| | 518 | 30800 | 531 | 30812 | 542 | 30824 |
| | 524 | 30804 | 532 | 30814 | 545 | 30828 |
| 8596 | 525 | 30806 | 533 | 30816 | white 555 | 30830 |
| | 528 | 30808 | 536 | 30820 | light grey 556 | 30832 |
| | 530 | 30810 | 540 | 30822 | black 557 | 30834 |

euro/m

2,15

no partial packaging

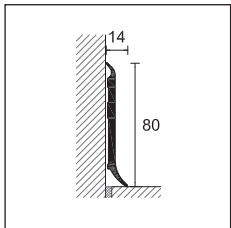

8598

PVC LINE

length = 250 cm - pack 40 pcs

FOAM PVC

H = 80 mm

| ART. | decors | |
|------|----------------|-------|
| | white 555 | 30880 |
| 8598 | light grey 556 | 30882 |
| | black 557 | 30884 |

euro/m

2,37

no partial packaging

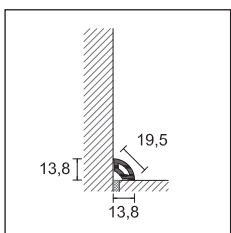

8580

PVC LINE

length = 250 cm - pack 80 pcs

FOAM PVC

| ART. | decors | | decors | |
|------|--------|-------|----------------|-------|
| | 532 | 30764 | white 555 | 30780 |
| 8580 | 542 | 30774 | light grey 556 | 30782 |
| | 545 | 30778 | black 557 | 30784 |

euro/m

0,67

no partial packaging

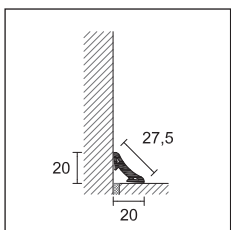

8582

PVC LINE

length = 250 cm - pack 60 pcs

FOAM PVC

| ART. | decors | | decors | |
|------|--------|-------|----------------|-------|
| | 532 | 30714 | white 555 | 30730 |
| 8582 | 542 | 30724 | light grey 556 | 30732 |
| | 545 | 30728 | black 557 | 30734 |

euro/m

1,11

no partial packaging

For a single piece, see sales conditions on page 288

PVC Line 8602 is an impact-resistant and 48-mm high skirting board in foam PVC. It is particularly suitable for DIY installation, thanks to the speed and easiness of application. It is available in different colours and it is installed with a simple interlocking system with harmonic stainless steel clips. In addition to their decorative function, it allows to hide the expansion gap perimeter of floating wood and laminate floors.



8602 Foam PVC

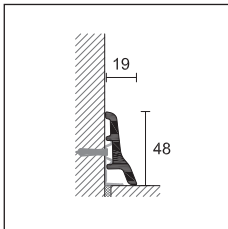

8602

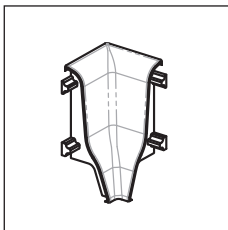

8602/I

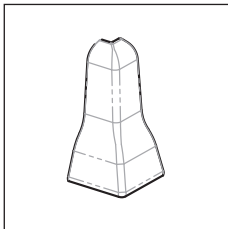

8602/E

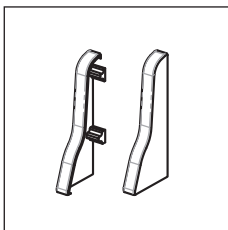

8602/P



8602/C fixing clips

PVC LINE

length 250 cm - pack 40 pcs

FOAM PVC

H = 48 mm

| ART. | decors | |
|---------------|----------------|-------------|
| | white 555 | 29530 |
| 8602 | light grey 556 | 29532 |
| | black 557 | 29534 |
| euro/m | | 1,49 |

no partial packaging

INSIDE CORNER

pack 10 pcs

POLYPROPYLENE

H = 48 mm

| ART. | decors | |
|----------------|----------------|-------------|
| | white 555 | 29578 |
| 8602/I | light grey 556 | 29580 |
| | black 557 | 29582 |
| euro/pc | | 1,40 |

no partial packaging

OUTSIDE CORNER

pack 10 pcs

POLYPROPYLENE

H = 48 mm

| ART. | decors | |
|----------------|----------------|-------------|
| | white 555 | 29628 |
| 8602/E | light grey 556 | 29630 |
| | black 557 | 29632 |
| euro/pc | | 1,40 |

no partial packaging

RIGHT/LEFT END CAPS

pack 10 pcs

POLYPROPYLENE

H = 48 mm

| ART. | decors | |
|----------------|----------------|-------------|
| | white 555 | 29728 |
| 8602/P dx/sx | light grey 556 | 29730 |
| | black 557 | 29732 |
| euro/pc | | 1,40 |

no partial packaging

FIXING CLIPS

10 blister packs / 20 pcs/blister

| | | |
|---------------------|--|-------------|
| 8602/C | | 29750 |
| euro/blister | | 5,93 |

For a single piece, see sales conditions on page 288

skirting board

pvc line

PVC Line 8603 is an impact-resistant and 70-mm high skirting board in foam PVC. It is particularly suitable for DIY installation, thanks to the speed and easiness of application. It is available in different colours and it can be installed with a simple interlocking system with harmonic stainless steel clips. In addition to its decorative function, it allows to hide the expansion gap perimeter of floating wood and laminate floors.



8603 Foam PVC decor 555

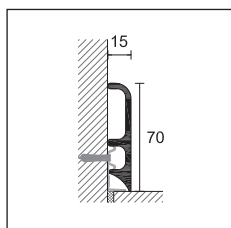

8603

PVC LINE

length 250 cm - pack 40 pcs

FOAM PVC

H = 70 mm

| ART. | decors | |
|------|----------------|-------|
| | 532 | 30144 |
| | 542 | 30154 |
| | 545 | 30158 |
| 8603 | white 555 | 30160 |
| | light grey 556 | 30162 |
| | black 557 | 30164 |

euro/m 2,29

no partial packaging

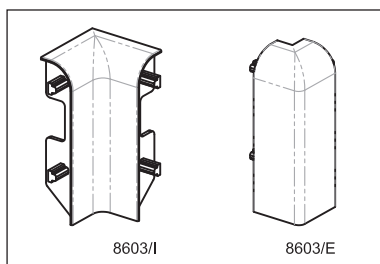

8603/I

8603/E

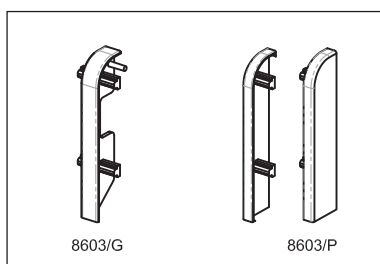

8603/G

8603/P

INSIDE CORNER

pack 10 pcs

POLYPROPYLENE

H = 70 mm

| ART. | decors | |
|--------|----------------|-------|
| | 532 | 30194 |
| | 542 | 30204 |
| | 545 | 30208 |
| 8603/I | white 555 | 30210 |
| | light grey 556 | 30212 |
| | black 557 | 30214 |

euro/pc 1,40

no partial packaging

OUTSIDE CORNER

pack 10 pcs

POLYPROPYLENE

H = 70 mm

| ART. | decors | |
|--------|----------------|-------|
| | 532 | 30244 |
| | 542 | 30254 |
| | 545 | 30258 |
| 8603/E | white 555 | 30260 |
| | light grey 556 | 30262 |
| | black 557 | 30264 |

euro/pc 1,40

no partial packaging

JUNCTION

pack 10 pcs

POLYPROPYLENE

H = 70 mm

| ART. | decors | |
|--------|----------------|-------|
| | 532 | 30294 |
| | 542 | 30304 |
| | 545 | 30308 |
| 8603/G | white 555 | 30310 |
| | light grey 556 | 30312 |
| | black 557 | 30314 |

euro/pc 1,28

no partial packaging

RIGHT/LEFT END CAPS

pack 10 pcs

POLYPROPYLENE

H = 70 mm

| ART. | decors | |
|--------------|----------------|-------|
| | 532 | 30344 |
| | 542 | 30354 |
| | 545 | 30358 |
| 8603/P dx/sx | white 555 | 30360 |
| | light grey 556 | 30362 |
| | black 557 | 30364 |

euro/pc 1,40

no partial packaging



8602/C fixing clips

FIXING CLIPS

10 blister packs / 20 pcs/blister

| | |
|---------------------|-------------|
| 8602/C | 29750 |
| euro/blister | 5,93 |

PVC Line 8607 is an impact-resistant and 70-mm high skirting board in foam PVC. It is particularly suitable for DIY installation, thanks to the speed and easiness of application. It is available in different colours and it can be installed with a simple interlocking system with harmonic stainless steel clips. In addition to its decorative use, it allows to hide the expansion gap perimeter of floating wood and laminate floors.



8607 Foam PVC decor 532

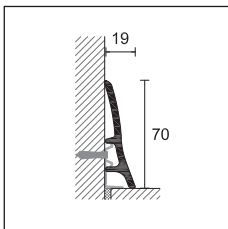

8607

PVC LINE

length 250 cm - pack 40 pcs

FOAM PVC

H = 70 mm

| ART. | decors | |
|------|----------------|-------|
| | 532 | 30414 |
| | 542 | 30424 |
| | 545 | 30428 |
| 8607 | white 555 | 30430 |
| | light grey 556 | 30432 |
| | black 557 | 30434 |

euro/m 2,16

no partial packaging

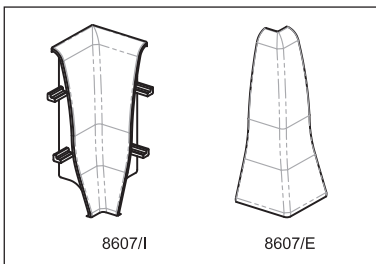

INSIDE CORNER

pack 10 pcs

POLYPROPYLENE

H = 70 mm

| ART. | decors | |
|--------|----------------|-------|
| | 532 | 30464 |
| | 542 | 30474 |
| | 545 | 30478 |
| 8607/I | white 555 | 30480 |
| | light grey 556 | 30482 |
| | black 557 | 30484 |

euro/pc 1,40

no partial packaging

OUTSIDE CORNER

pack 10 pcs

POLYPROPYLENE

H = 70 mm

| ART. | decors | |
|--------|----------------|-------|
| | 532 | 30514 |
| | 542 | 30524 |
| | 545 | 30528 |
| 8607/E | white 555 | 30530 |
| | light grey 556 | 30532 |
| | black 557 | 30534 |

euro/pc 1,40

no partial packaging

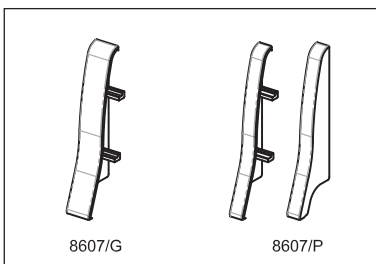

JUNCTION

pack 10 pcs

POLYPROPYLENE

H = 70 mm

| ART. | decors | |
|--------|----------------|-------|
| | 532 | 30564 |
| | 542 | 30574 |
| | 545 | 30578 |
| 8607/G | white 555 | 30580 |
| | light grey 556 | 30582 |
| | black 557 | 30584 |

euro/pc 1,28

no partial packaging

RIGHT/LEFT END CAPS

pack 10 pcs

POLYPROPYLENE

H = 70 mm

| ART. | decors | |
|-------------|----------------|-------|
| | 532 | 30614 |
| | 542 | 30624 |
| | 545 | 30628 |
| 8607P dx/sx | white 555 | 30630 |
| | light grey 556 | 30632 |
| | black 557 | 30634 |

euro/pc 1,40

no partial packaging



8602/C fixing clips

FIXING CLIPS

10 blister packs / 20 pcs/blister

8602/C 29750

euro/blister 5,93

skirting board

pvc line

PVC Line 148 is a skirting board for carpet and PVC coverings, composed of a base in rigid PVC and clip in soft PVC. Used as internal corner connection profile, it creates a curvature on the corner once the covering has been laid. It also allows to finish and cover the extremities of the carpet or the PVC covering, thus covering any cutting inaccuracies. This profile is recommended for public spaces such as hospitals and schools.



172 PVC white

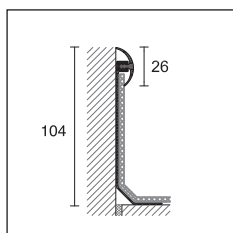

148/B +
148/C

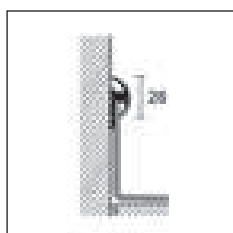

148/BR +
148/C

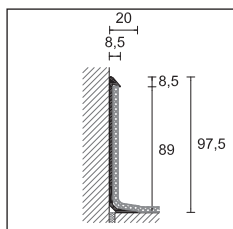

172

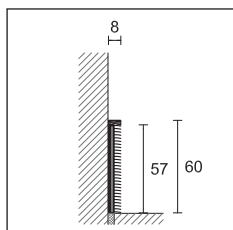

173

PVC LINE - BASE

length = 300 cm - pack 30 pcs

ART. finishing

WHITE RIGID PVC

| | | | |
|--------|---------------|--------------------------|-------------|
| 148/B | PVC white | <input type="checkbox"/> | 19095 |
| | <i>euro/m</i> | | 2,59 |
| 148/BR | PVC white | <input type="checkbox"/> | 19094 |
| | <i>euro/m</i> | | 1,74 |

no partial packaging

PVC LINE - CLIP

length = 305 cm - pack 30 pcs

ART. finishing

PVC MORBIDO

| | | | |
|-------|---------------|--------------------------|-------------|
| 148/C | PVC white | <input type="checkbox"/> | 19096 |
| | PVC ash grey | <input type="checkbox"/> | 19097 |
| | PVC sand | <input type="checkbox"/> | 19098 |
| | <i>euro/m</i> | | 2,09 |

no partial packaging

PVC LINE

length = 300 cm - pack 20 pcs

ART. finishing

PVC

| | | | |
|-----|---------------|--------------------------|-------------|
| 172 | PVC white | <input type="checkbox"/> | 19210 |
| | <i>euro/m</i> | | 3,82 |

no partial packaging

length = 300 cm - pack 20 pcs

ART. finishing

ALUMINIUM

| | | | |
|-----|-------------------------|--------------------------|-------------|
| 173 | silver anodised drilled | <input type="checkbox"/> | 19215 |
| | <i>euro/m</i> | | 6,77 |

no partial packaging

MS POLYMER-BASED ADHESIVE FOR SKIRTING BOARDS

quantity 290 ml - pack 24 pcs

| | | |
|----------------|--|--------------|
| PP/96 | | 78301 |
| <i>euro/pc</i> | | 18,81 |

output 10/15 m for cartridge

148/C is available in different colours on request

For a single piece, see sales conditions on page 288

PVC Line 170, 169 and 171 are cover-shaped connection profiles in plastic-coated PVC. Recommended for the laying of carpet and PVC coverings, they even out the curvature between the floor and the wall.



171 black PVC

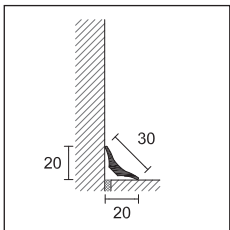

170

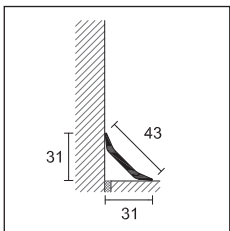

169

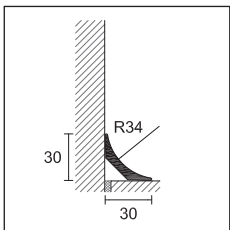

171

PVC LINE - COVE-SHAPED

| | | |
|-------------------------------|------------------|-------------|
| length = 200 cm - pack 50 pcs | | H |
| ART. | finishing | 20 |
| PVC | | |
| 170 | black | 19200 |
| | <i>euro/m</i> | 1,37 |

no partial packaging

PVC LINE - COVE-SHAPED

| | | |
|-------------------------------|------------------|-------------|
| length = 200 cm - pack 50 pcs | | H |
| ART. | finishing | 31 |
| PVC | | |
| 169 | black | 19195 |
| | <i>euro/m</i> | 2,00 |

no partial packaging

PVC LINE - COVE-SHAPED

| | | |
|-------------------------------|------------------|-------------|
| length = 200 cm - pack 50 pcs | | H |
| ART. | finishing | 30 |
| PVC | | |
| 171 | black | 19205 |
| | <i>euro/m</i> | 2,52 |

no partial packaging

All articles PVC line cove-shaped should be stored horizontally.

For a single piece, see sales conditions on page 288





prolight

Prolight is a line of light profiles with direct and indirect lighting. The integration of the LED technology with Profilpas profiles allows to customize every space. Available in warm, neutral or RGB light and provided with dimmer, they are easy to install and give the suitable light for each use, from the spaces for relaxation to work ones.

Prolight Prolist LLA and LLB are two aluminium decorative listellos with direct LED light. Suitable for framing mirrors and walls and illuminating recessed niches and shelves, these profiles add value to the space, finding an ideal location in bathrooms, kitchens and private space in general. Prolight Prolist LLA/20/10, in particular, is perfect for shower recessed niches to create pleasant plays of light.



LLA/20/10 silver anodised aluminium

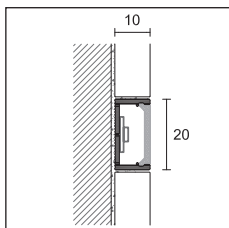

LLA/20

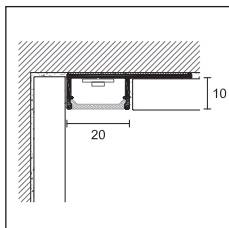

LLA/20/10

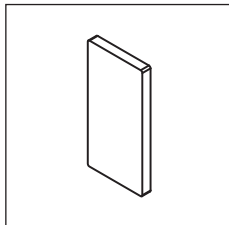

LLA/20P

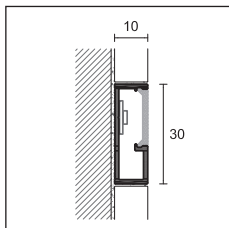

LLA/30
LLB/30

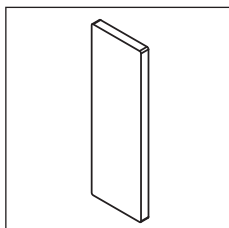

LLA/30P
LLB/30P

Spare insert in opaline ABS for art. LLA/20, LLA/20/10, LLA/30 and LLB/30 code 84069 L 270 cm - pack 20 pcs euro/m 2,42

For the best aesthetic result and the validity of the warranty, we suggest the exclusive use of our electrical components. See page 240

We recommend the use of NT LED strip with continuous light, see page 240

For a single piece, see sales conditions on page 288

PROLIGHT PROLIST

length = 270 cm - pack 10 pcs **LxH**

ART. finishing **20x10**

ALUMINIUM

| | | | |
|---------------|-----------------|--|-------------|
| LLA/20 | silver anodised | | 84070 |
| | euro/m | | 8,58 |

individually packed

PROLIGHT PROLIST

length = 270 cm - pack 10 pcs **H**

ART. finishing **10**

ALUMINIUM

NEW

| | | | |
|------------------|-----------------|--|--------------|
| LLA/20/10 | silver anodised | | 84076 |
| | euro/m | | 12,60 |

individually packed

END CAPS FOR LLA/20 AND LLA/20/10

pack 5 pcs

ART. finishing

ALUMINIUM

| | | | |
|----------------|-----------------|--|-------------|
| LLA/20P | silver anodised | | 84072 |
| | euro/pc | | 6,10 |

no partial packaging

PROLIGHT PROLIST

length = 270 cm - pack 10 pcs **LxH**

ART. finishing **30x10**

ALUMINIUM

| | | | |
|---------------|------------------------|--|--------------|
| LLA/30 | silver anodised | | 84080 |
| | euro/m | | 10,40 |
| LLB/30 | bright polished silver | | 84081 |
| | euro/m | | 13,14 |

individually packed

END CAPS FOR LLA/30 AND LLB/30

pack 5 pcs

ART. finishing

ALUMINIUM

| | | | |
|----------------|------------------------|--|-------------|
| LLA/30P | silver anodised | | 84082 |
| | euro/pc | | 6,10 |
| LLB/30P | bright polished silver | | 84083 |
| | euro/pc | | 7,62 |

no partial packaging

Prolight Prolist TLA is an aluminium decorative listello with indirect LED light, suitable for framing mirrors or outlining walls and coverings.
Prolight Prolist CLA is ideal under wall cabinets, in kitchens, bathrooms, wardrobes and showcases.



TLA/10/C1 silver anodised aluminium

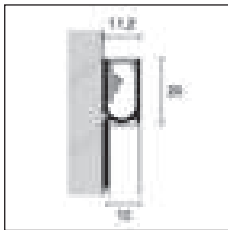

TLA/10/C1
TLB/10/C1

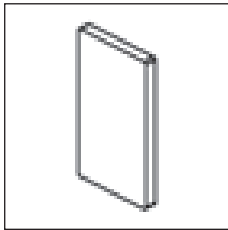

TLA/10P/C1
TLB/10P/C1

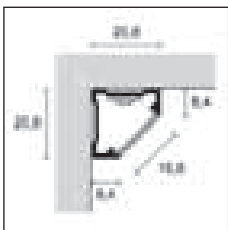

CLA/8
CLA/8A

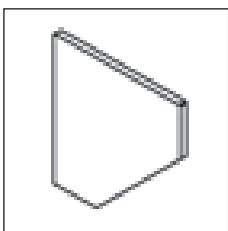

CLA/8P

Spare insert in opaline ABS for art. CLA/8 and CLA/8A code 84069 L 270 cm - pack 20 pcs euro/m 2,42

For the best aesthetic result and the validity of the warranty, we suggest the exclusive use of our electrical components. See page 240

We recommend the use of NT LED strip with continuous light, see page 240

For a single piece, see sales conditions on page 288

PROLIGHT PROLIST

length = 270 cm - pack 10 pcs

| ART. | finishing | | LxH |
|------------------|------------------------|--|--------------|
| | | | 20x10 |
| ALUMINIUM | | | |
| TLA/10/C1 | silver anodised | | 84090 |
| | euro/m | | 12,32 |
| TLB/10/C1 | bright polished silver | | 84091 |
| | euro/m | | 15,09 |

individually packed

END CAPS FOR TLA/10/C1

pack 5 pcs

| ART. | finishing | | |
|------------------|------------------------|--|-------------|
| ALUMINIUM | | | |
| TLA/10P/C1 | silver anodised | | 84092 |
| | euro/pc | | 6,37 |
| TLB/10P/C1 | bright polished silver | | 84093 |
| | euro/pc | | 8,04 |

no partial packaging

PROLIGHT PROLIST

length = 270 cm - pack 10 pcs

| ART. | finishing | | H |
|------------------|-----------------|--|--------------|
| | | | 8 |
| ALUMINIUM | | | |
| CLA/8 | silver anodised | | 84221 |
| | euro/m | | 11,76 |
| CLA/8A | silver anodised | | 84222 |
| | adesivo | | |
| | euro/m | | 15,91 |

individually packed

END CAPS FOR CLA/8

pack 5 pcs

| ART. | finishing | | H |
|------------------|-----------------|--|-------------|
| | | | 8 |
| ALUMINIUM | | | |
| CLA/8P | silver anodised | | 84223 |
| | euro/pc | | 6,10 |

no partial packaging

Prolight Prolist Q LQL/2 is an aluminium decorative listello with indirect LED light that, thanks to its particular section, creates a delicate and elegant light effect on the ceramic coverings, thus embellishing the wall. This profile is available in a wide range of colours including white stone, five original cement effects, two special metal tonalities and a white characterized by an extremely solid and full colour.

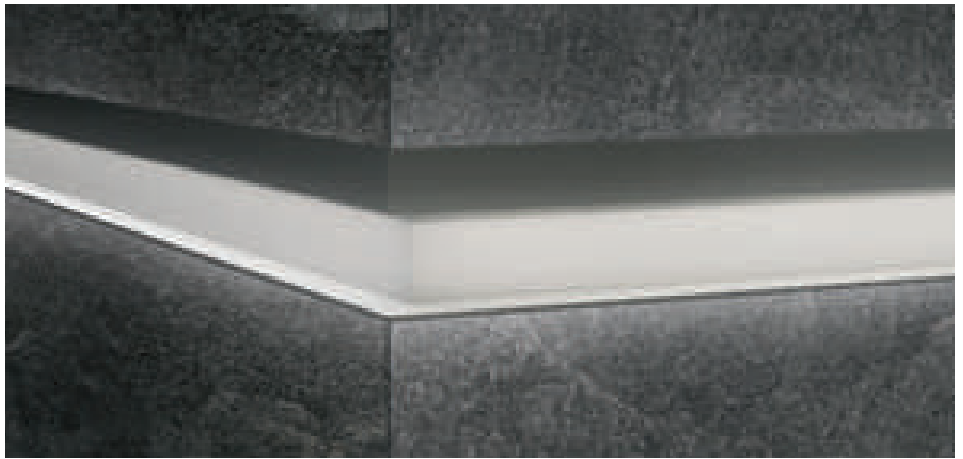

LQL/2 metal light colour-coated aluminium

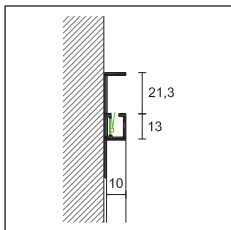

LQL/2

PROLIGHT PROLIST Q

length = 270 cm - pack 5 pcs

| length = 270 cm - pack 5 pcs | | H |
|--------------------------------|-------------------|--------------|
| ART. | finishing | 10 |
| COLOUR-COATED ALUMINIUM | | |
| | white stone | 84020 |
| | concrete white | 84021 |
| | concrete graphite | 84022 |
| | concrete smoke | 84023 |
| LQL/2 | concrete mud | 84024 |
| | concrete sand | 84025 |
| | metal dark | 84026 |
| | metal light | 84027 |
| | solid white | 84028 |
| | euro/m | 19,18 |

individually packed

ELECTRICAL COMPONENTS AND ACCESSORIES FOR LIGHTING

| ART. | description | |
|------------|--|-----------------------|
| L5/NW/65 L | spool 5 m LED strips, lateral light, neutral colour 4000 °K, 9,6W/m IP65 | 84136 |
| | euro/mt (euro/pack) | 33,13 (165,63) |

For the best aesthetic result and the validity of the warranty, we suggest the exclusive use of our electrical components. See page 240

For other electrical components see page 240

For a single piece, see sales conditions on page 288

Prolight Proangle Q ZQAL is a natural aluminium profile for external corners. Equipped with a diffuser in different colours, it helps increasing safety in public and private spaces through a thin luminous line.

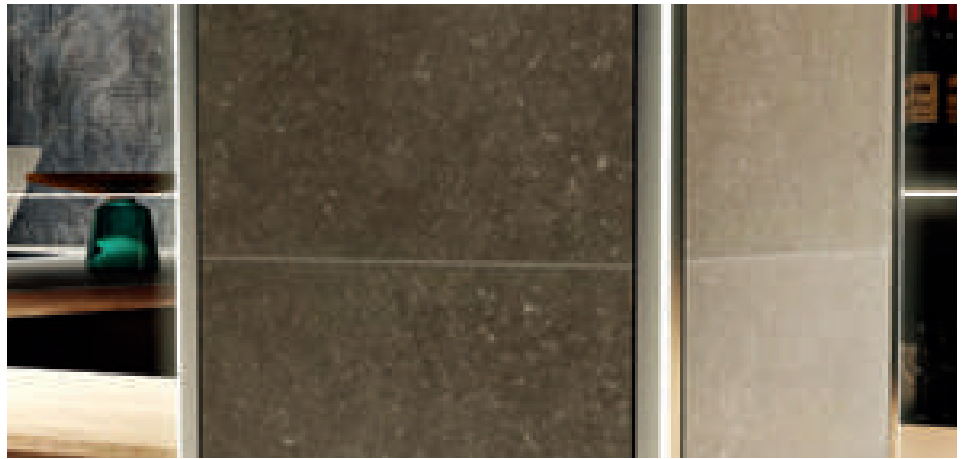

ZQAL/10B natural aluminium + ZQAL/10 white opaline PVC

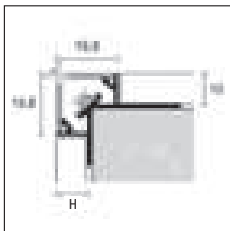

ZQAL/...B+ZQAL/10

PROLIGHT PROANGLE Q

length = 270 cm - pack 10 pcs H

| ART. | finishing | 10 | 13 |
|------|-----------|----|----|
|------|-----------|----|----|

ALUMINIUM

| | | | |
|----------|------------------------|--|--------------|
| ZQAL/10B | natural aluminium base | | 87226 |
| | <i>euro/m</i> | | 10,40 |

| | | | |
|----------|------------------------|--|--------------|
| ZQAL/13B | natural aluminium base | | 87227 |
| | <i>euro/m</i> | | 10,66 |

OPALINE PVC

| | | | |
|---------|---------------|--|-------------|
| | white | | 87230 |
| ZQAL/10 | grey | | 87231 |
| | red | | 87232 |
| | yellow | | 87233 |
| | <i>euro/m</i> | | 8,45 |

Items available in different colours on demand minimum quantity 540 meters

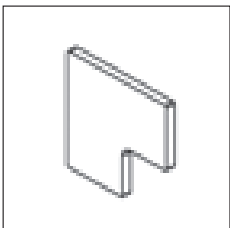

ZQAL/...P

END CAPS FOR ZQAL

pack 5 pcs H

| ART. | finishing | 10 | 13 |
|------|-----------|----|----|
|------|-----------|----|----|

ALUMINIUM

| | | | |
|----------|-------------------|--|-------------|
| ZQAL/10P | natural aluminium | | 87229 |
| | <i>euro/pc</i> | | 6,10 |

| | | | |
|----------|-------------------|--|-------------|
| ZQAL/13P | natural aluminium | | 87228 |
| | <i>euro/pc</i> | | 6,10 |

no partial packaging

For the best aesthetic result and the validity of the warranty, we suggest the exclusive use of our electrical components. See page 240

We recommend the use of NT LED strip with continuous light, see page 240

For a single piece, see sales conditions on page 288

cerfix® prostep - protect

Prolight Prostep SGA is an aluminium profile with indirect LED light for the protection and finishing of ceramic, marble and stone steps. With SGA, the light diffuses softly downwards, giving elegance and refinement to the stair, as well as increasing the safety of the space.

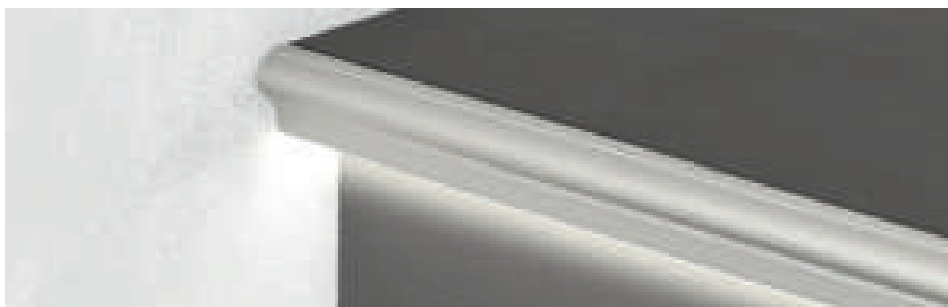

SGA/11L silver anodised aluminium

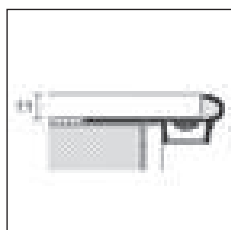

SGA/11L

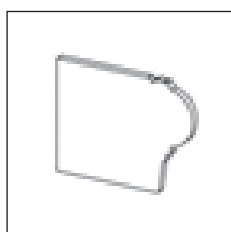

SGA/11P

PROLIGHT PROSTEP

length = 270 cm - pack 10 pcs

H mm

ART. finishing

11

ALUMINIUM

SGA/11L silver anodised



94969

euro/m

17,12

individually packed

END CAPS FOR PROFILE SGA/11L

pack 5 pcs

H mm

ART. finishing

11

ALUMINIUM

SGA/11P silver anodised



94964

euro/pc

8,87

no partial packaging

Prolight Protect G/9 is a stair nosing profile in aluminium equipped with direct LED light and a non-slip knurled surface. G/9 is suitable for public spaces such as cinemas, offices, theatres, clubs and boats, making them welcoming and elegant at the same time.



G/9/SF silver anodised aluminium

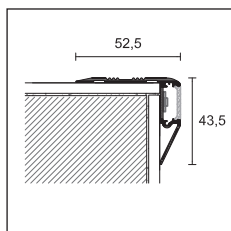

G/9/F

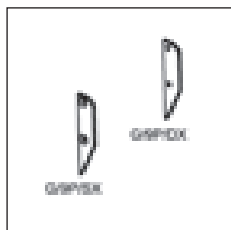

G/9P/

Spare insert in opaline ABS for art. SGA/11L and G/9/F code 84069 L 270 cm - pack 20 pcs euro/m 2,42

For the best aesthetic result and the validity of the warranty, we suggest the exclusive use of our electrical components. See page 240

We recommend the use of NT LED strip with continuous light, see page 240

For a single piece, see sales conditions on page 288

PROLIGHT PROTECT

length = 270 cm - pack 10 pcs

ART. finishing

ALUMINIUM

G/9/F silver anodised



84050

euro/m

17,43

individually packed

END CAPS FOR PROFILE G/9/F

pack 5 pcs

ART. finishing

ALUMINIUM

G/9P/DX silver anodised



84052

euro/pc

7,49

G/9P/SX silver anodised



84053

euro/pc

7,49

no partial packaging

Prolight Protect 126/L/F is an aluminium stair nosing profile equipped with direct LED light and replaceable rubber insert. 126/L/F is suitable for public spaces such as cinemas, offices, theatres, clubs and boards, making them welcoming and elegant at the same time.



126/L/F silver anodised aluminium + GMR/44 black striped rubber

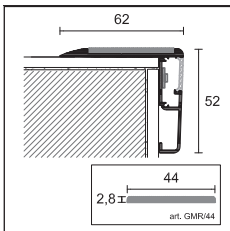

126/L/F

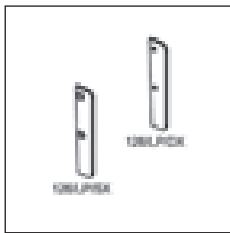

126/LP

PROLIGHT PROTECT

length = 270 cm - pack 6 pcs

ART. finishing

ALUMINIUM

| | | | |
|----------------|-----------------|---|--------------|
| 126/L/F | silver anodised |  | 84060 |
| | <i>euro/m</i> | | 20,19 |

individually packed

GROOVED RUBBER

length = 1700 cm - 1 rolls pack

ART.

| | | | |
|---------------|---------------|---|-------------|
| GMR/44 | black |  | 75706 |
| | <i>euro/m</i> | | 6,30 |

END CAPS FOR 126/L/F

pack 5 pcs

ART. finishing

ALUMINIUM

| | | | |
|------------------|-----------------|---|-------------|
| 126/LP/DX | silver anodised |  | 84062 |
| | <i>euro/pc</i> | | 7,49 |
| 126/LP/SX | silver anodised |  | 84063 |
| | <i>euro/pc</i> | | 7,49 |

no partial packaging

Spare insert in opaline ABS for art. 126/L/F code 84069 L 270 cm - pack 20 pcs euro/m 2,42

For the best aesthetic result and the validity of the warranty, we suggest the exclusive use of our electrical components. See page 240

We recommend the use of NT LED strip with continuous light, see page 240

For a single piece, see sales conditions on page 288



metal line S

Prolight Metal Line SKL/2 is a skirting board in aluminium with indirect LED light. Its special section allows to create an original play of light along the wall, thus adding value to the whole surface. In addition to the silver anodised and the white stone versions, SKL/2 is available in 8 finishes: a range of colours including five original cement effects, two special metal tonalities and a white characterized by an extremely solid and full colour.



SKL/2 concrete white colour-coated aluminium

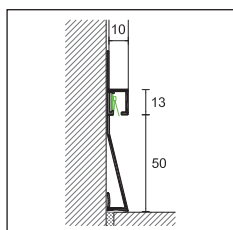

SKL/2

PROLIGHT METAL LINE S

length = 270 cm - pack 5 pcs

H

ART. finishing

10

ALUMINIUM

| | | |
|-------|-----------------|--------------|
| SKL/2 | silver anodised | 78579 |
| | <i>euro/m</i> | 14,74 |

COLOUR-COATED ALUMINIUM

| | | |
|-------|-------------------|--------------|
| SKL/2 | white stone | 78591 |
| | concrete white | 78592 |
| | concrete graphite | 78593 |
| | concrete smoke | 78594 |
| | concrete mud | 78595 |
| | concrete sand | 78596 |
| | metal dark | 78597 |
| | metal light | 78598 |
| | solid white | 78599 |
| | <i>euro/m</i> | 25,28 |

individually packed

ELECTRICAL COMPONENTS AND ACCESSORIES FOR LIGHTING

| ART. | description | |
|------------|--|-----------------------|
| L5/NW/65 L | spool 5 m LED strips, lateral light, neutral colour 4000 °K, 9,6W/m IP65 | 84136 |
| | <i>euro/mt (euro/pack)</i> | 33,13 (165,63) |

For the best aesthetic result and the validity of the warranty, we suggest the exclusive use of our electrical components. See page 240

For other electrical components see page 240

For a single piece, see sales conditions on page 288

Metal Line 88/I6L/A is a skirting board flush with the wall and with LED lighting system. The light is distributed along the whole length of the profile and passes through a visible gap. There is the possibility to insert the optional dimmer to adjust the light intensity of the skirting board and create both an elegant decoration and a night courtesy light.

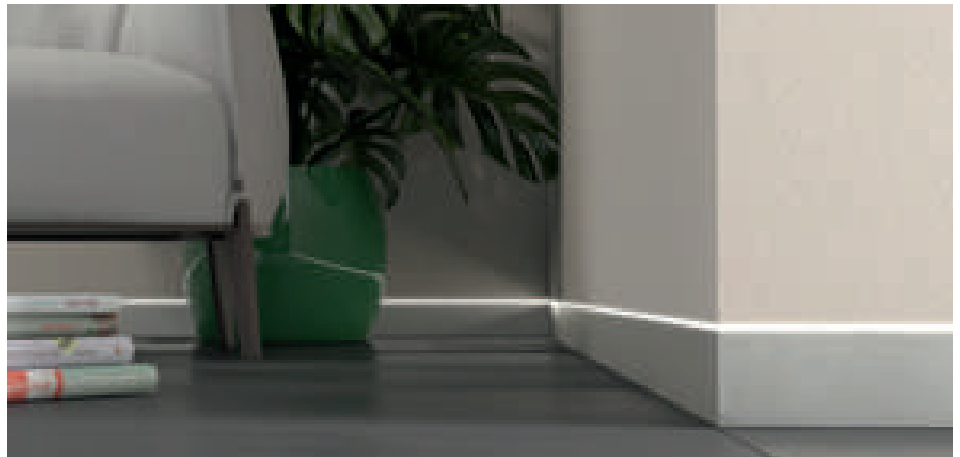

88/I6L/A silver anodised aluminium

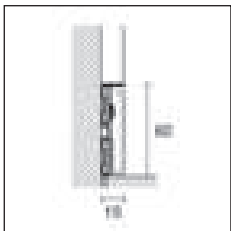

87/6 + 88/I6L

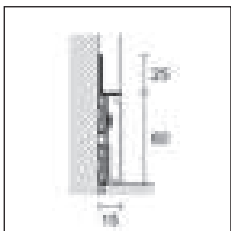

88/6 + 88/I6L

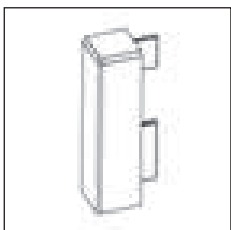

88/6E

METAL LINE 87 - 88

| length = 200 cm - pack 20 pcs | | H cm |
|-------------------------------|--|-----------------------|
| ART. | finishing | 6 |
| ALUMINIUM | | |
| 87/6 | natural aluminium (drilled) <i>euro/m</i> | 78338 11,41 |
| 88/6 | natural aluminium (drilled) <i>euro/m</i> | 78310 13,59 |

individually packed

ALUMINIUM INSERT FOR LED LIGHT

| length = 200 cm - pack 20 pcs | | H cm |
|-------------------------------|--|--------------------------------|
| 88/I6L/A | silver anodised colour-coated matt white RAL 9010 <i>euro/m</i> | 78559 78560 10,83 |

adesivo - individually packed

OUTSIDE CORNER IN METAL

| pack 4 pcs | | H cm |
|--------------|--|--------------------------------|
| ART. | finishing | 6 |
| 88/6E | silver colour-coated matt white RAL 9010 <i>euro/pc</i> | 78561 78562 10,12 |

no partial packaging

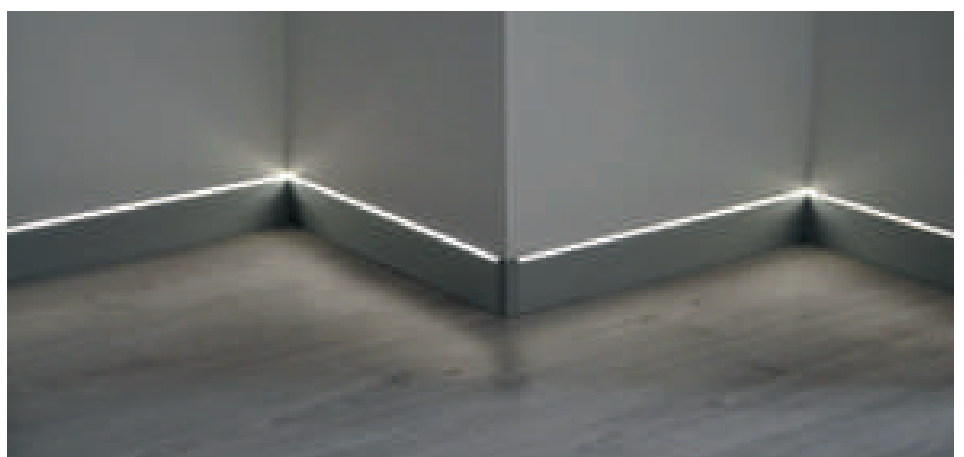

88/6 + 88/I6L/A silver anodised aluminium

For the best aesthetic result and the validity of the warranty, we suggest the exclusive use of our electrical components. See page 240

For a single piece, see sales conditions on page 288

metal line

Prolight Metal Line 89 is a skirting board in anodised aluminium with LED-strip lighting system. The light is distributed along the entire length of the profile through a diffuser element. It is possible to insert the dimmer in order to adjust the luminous intensity of the skirting board to decorate and light up the room.

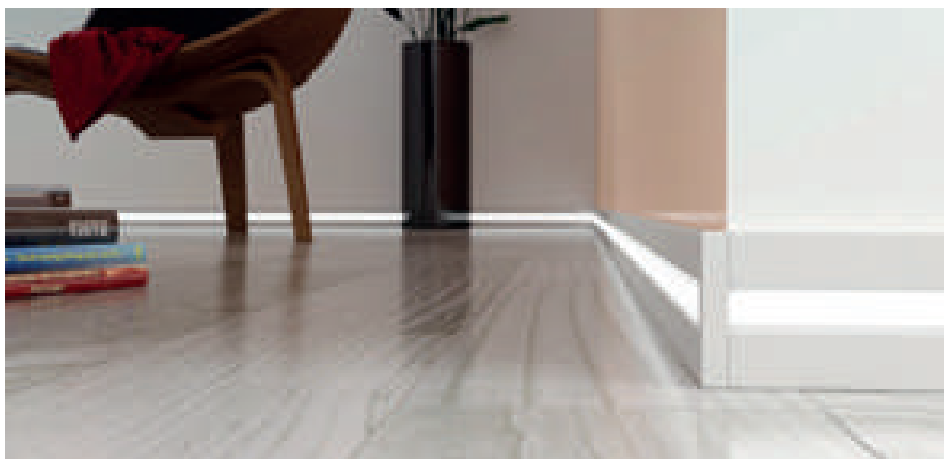

89/6L silver anodised aluminium

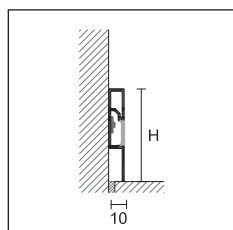

89/6L

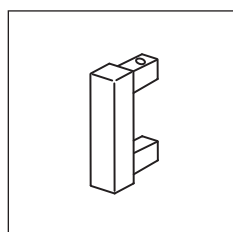

89/6EI

PROLIGHT METAL LINE 89

length = 200 cm - pack 25 pcs

H cm

ART. finishing

6

ALUMINIUM

89/6L silver anodised

86000

euro/m

14,66

individually packed

INSIDE/OUTSIDE CORNER - RIGHT/LEFT END CAP

pack 4 pcs

H cm

ART. finishing

6

ALUMINIUM

89/6EI silver anodised

78506

euro/pc

10,28

no partial packaging

Spare insert in opaline ABS for art. 89/6L code 84069 L 270 cm - pack 20 pcs euro/m 2,42

For the best aesthetic result and the validity of the warranty, we suggest the exclusive use of our electrical components. See page 240

We recommend the use of NT LED strip with continuous light, see page 240

For a single piece, see sales conditions on page 288

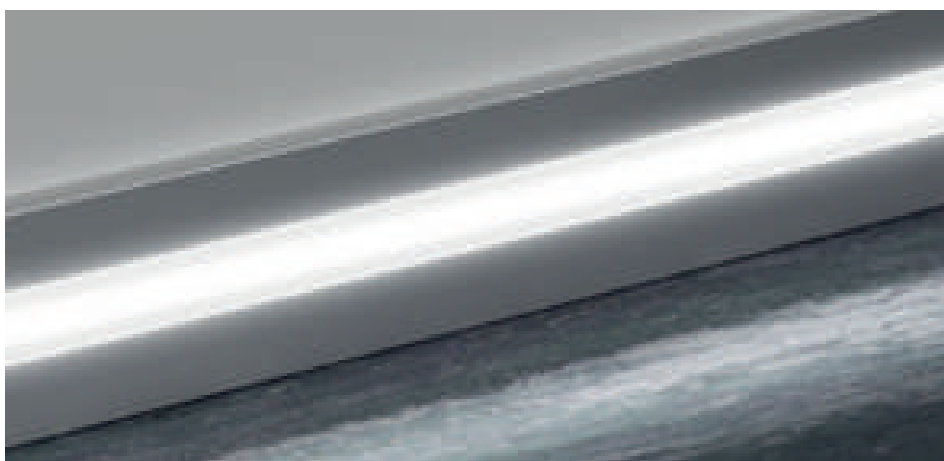

89/6L silver anodised aluminium

HOW TO ORDER THE ELECTRICAL COMPONENTS

LED (white light)

Measure how many meters of LED strip have to be positioned on our profiles. A spool is 5 meters long. Spools have 120 LED every meter. The voltage is 24 volt. The consumption is 9,6 watts every meter. To determine the consumption, length must be multiplied by 9,6 watts.

Example: calculation of the watts consumption = 7,4m x 9,6W = 71 total watts

Choose the colour of the light. LED strips are available in neutral white light (4000 °K) or warm white light (3000 °K).

Choose the degree of protection: IP33 for inside and dry spaces, IP67 for outside or moist spaces.

POWER SUPPLIES

Choose the suitable power supply on the basis of the total watts and so as not to exceed 90% of the maximum power.

Example: 71W : 90 x 100 = 79W - use a power supply of 90W

| | ART. | | |
|----------------------|------|-----------|-------|
| from 5 cm to 5,5 m | 60W | AL/60/24 | 84150 |
| from 5,6 m to 8,4 m | 90W | AL/90/24 | 84152 |
| from 8,5 m to 11,2 m | 120W | AL/120/24 | 84154 |
| from 11,3 m to 14 m | 150W | AL/150/24 | 84156 |

We recommend to power the LED strips every 3 meters in order to avoid differences in brightness and the overheating of the LED in the initial part of them. A cable with 1 mm² section has a maximum range of about 4 Amp and a voltage drop of 1 Volt every 10 meters. For special installations, please contact our Technical Department.

DIMMER (optional)

The dimmer/fader/driver has the function to adjust the light intensity of LED light, it supports maximum 10 Amp to an equal extent of 25 linear meters of our LED strip. It must be placed between the power supply and the LED strip and connected to a switch (not supplied) and/or to the receiver of the remote control (optional).

In case of more lines with simultaneous turning on, the first dimmer is connected in Sync mode and it will switch on the consecutive dimmers.

Example: to connect 3 lines with simultaneous turning on, you need to use 3 dimmers.

REMOTE CONTROL + RECEIVER (optional)

The remote control is a radiofrequency and can control up to 4 channels; it is used to turn on/off the LED.

The receiver must be installed between the power supply and the LED strip or connected to the dimmer if present.

If there is also the dimmer, the remote control can adjust the LED light intensity.

ELECTRICAL CABLES

The cables are necessary to connect the power supply to the LED strips where needed.

A cable with 1 mm² section has a maximum range of about 4 amps and a voltage drop of 1 volt every 10 meters.

CONNECTORS

Art. IR/C01 connects the LED strips to the line of power supply.
Art. IR/W3 connects maximum 3 cables among them.

LED RGB (coloured light)

Measure how many meters of LED strip have to be positioned on our profiles. A spool is 5 meters long. Spools can be cut every 10 cm. The voltage is 24 volt. The consumption is 14,4 watts every meter. To determine the consumption, length must be multiplied by 14,4 watts.

Example: calculation of the watts consumption = 7,4m x 14,4W = 106,6 total watts

RGB LED strips are available in degree of protection IP67, are covered with silicone sheath and are provided with adhesive for the fastening in inside or outside spaces.

POWER SUPPLIES

Choose the suitable power supply on the basis of the total watts and so as not to exceed 90% of the maximum power.

Example: 106,60W : 90 x 100 = 118W - use a power supply of 120W

| | ART. | | |
|---------------------|------|-----------|-------|
| from 10 cm to 3,7 m | 60W | AL/60/24 | 84150 |
| from 3,8 m to 5,5 m | 90W | AL/90/24 | 84152 |
| from 5,6 m to 7,5 m | 120W | AL/120/24 | 84154 |
| from 7,6 m to 9,3 m | 150W | AL/150/24 | 84156 |

We recommend to power the LED strips every 3 meters in order to avoid differences in brightness and the overheating of the LEDs in the initial part. A cable with 1 mm² section has a maximum range of about 4 amp and a voltage drop of 1 volt every 10 meters. For length over 9,3 meters, see SLAVE paragraph. For special installations, please contact our Technical Department.

REMOTE CONTROL

The remote control is a radiofrequency and can control up to 4 channels; it is used to turn on/off the LED, adjust light intensity and choose the colour or the sequence of LEDs.

MASTER CONTROL UNIT

Connected with the remote control, it is used to turn on/turn off/adjust light intensity and to choose the colour or the sequence of LEDs.

It must be connected between the power supply and the LED strip.

SLAVE CONTROL UNIT

Every time that the system needs more lines controlled by just one unit, there is the need to add 1 slave for every added line.

Example: to connect 3 lines with simultaneous lighting, you need to use 1 master control unit and 2 slave control units.

The slave control unit must be connected to the master control unit with RJ11 6-poles cable (not supplied).

ELECTRICAL CABLES

The cable has 4 poles, 3 of them have a 0,5 mm² section (for the three colours), one of them has a 1 mm² section (for the negative pole).

CONNECTORS

Art. IR/C02 connects the LED strips with coloured light to the line of power supply, length of 15 cm.
Art. IR/C03 connects LED strips to LED strips with coloured light, length of 15 cm.

We recommend to assign the assembly of the electrical components to qualified staff.

Electrical components and accessories for Prolight profiles. Each element has to be chosen depending on the established length of the light profiles. It is necessary to calculate the power consumption in W/m for choosing one or more power supplies to be combined with the dimmer and the controller.



spool 5 m NT LED strip



L5/.../33



L5/.../67



AL.../24



DIMM/02



TEL/04



TEL/RGB/04



RIC/01

ELECTRICAL COMPONENTS AND ACCESSORIES FOR LIGHTING

| ART. | description | |
|-----------------------|---|--------------------------------|
| L5/NW/33 | spool 5 m LED strip colour neutral white 4000° K - 9,6W/m - IP33 <i>euro/m (euro/pack)</i> | 84105 16,30 (81,50) |
| L5/WW/33 | spool 5 m LED strip colour warm white 3000° K - 9,6W/m - IP33 <i>euro/m (euro/pack)</i> | 84115 16,30 (81,50) |
| L5/NW/67 | spool 5 m LED strip colour neutral white 4000° K - 9,6W/m - IP67 <i>euro/m (euro/pack)</i> | 84125 25,34 (126,68) |
| L5/WW/67 | spool 5 m LED strip colour warm white 3000° K - 9,6W/m - IP67 <i>euro/m (euro/pack)</i> | 84135 25,34 (126,68) |
| L5/RGB/67 | spool 5 m RGB LED strip - 14,4 W/m - IP67 <i>euro/m (euro/pack)</i> | 84140 33,13 (165,63) |
| NEW L5/NW/65NT | spool 5 m NT LED strip neutral white colour 4000° K - 10W/m - IP65 <i>euro/m (euro/pack)</i> | 84118 32,87 (164,37) |
| NEW L5/NW/67NT | spool 5 m NT LED strip neutral white colour 4000° K - 10W/m - IP67 <i>euro/m (euro/pack)</i> | 84122 40,33 (201,66) |
| AL/60/24 | power supply IP67 - PFC active - 24Vdc/60W <i>euro/pc</i> | 84150 82,92 |
| AL/90/24 | power supply IP67 - PFC active - 24Vdc/90W <i>euro/pc</i> | 84152 132,36 |
| AL/120/24 | power supply IP67 - PFC active - 24Vdc/120W <i>euro/pc</i> | 84154 239,51 |
| AL/150/24 | power supply IP67 - PFC active - 24Vdc/150W <i>euro/pc</i> | 84156 367,02 |
| DIMM/02 | dimmer/driver 24V/10 Amp - dim. mm 57x44x19 h. for white LED light <i>euro/pc</i> | 84187 83,52 |
| TEL/04 | 4- channel radio frequency remote control <i>euro/pc</i> | 84182 72,66 |
| RIC/01 | 4- remote control receiver radio frequency <i>euro/pc</i> | 84184 145,35 |
| TEL/RGB/04 | 4 channel radiofrequency remote control 433,92MHz for RGB LED diam. 80x13 h <i>euro/pc</i> | 84183 167,69 |

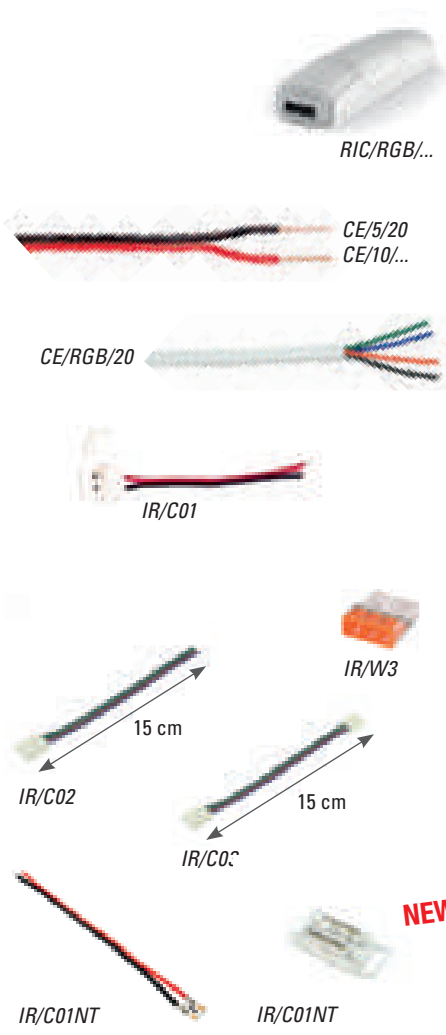

| | | |
|------------------|---|------------------------------|
| RIC/RGB/M | master control unit with dimmer functiona/wireless for RGB LED diam. 174x46x35 h <i>euro/pc</i> | 84185 393,51 |
| RIC/RGB/S | slave control unit whit dimmer function for RGB LED (maximum 4 slave for each master) <i>euro/pc</i> | 84186 274,92 |
| CE/5/20 | electrical cable sect. 0,5 mm ² - pack 20 ml <i>euro/m</i> | 84420 2,00 |
| CE/10/20 | electrical cable sect. 1 mm ² - pack 20 ml <i>euro/m</i> | 84422 2,00 |
| CE/10/100 | electrical cable sect. 1 mm ² - pack 100 ml <i>euro/m</i> | 84424 1,56 |
| CE/RGB/20 | electrical cable for RGB LED section 3x0,5 mm ² + 1x1 mm ² - pack 20 m <i>euro/m</i> | 84426 9,22 |
| IR/C01 | rapid fit connector for strip LED white light - pack 10 pcs <i>euro/pc</i> | 84411 3,89 |
| IR/W3 | rapid fit connector 3 cables - pack 10 pcs <i>euro/pc</i> | 84410 0,63 |
| IR/C02 | rapid fit connector RGB LED strip - pack 10 pcs <i>euro/pc</i> | 84415 4,10 |
| IR/C03 | rapid fit double connector RGB LED strip - pack 10 pcs <i>euro/pc</i> | 84416 6,22 |
| IR/C01NT | rapid fit connector for NT LED strip white light - pack 10 pcs <i>euro/pc (euro/pack)</i> | 84413 2,33 (23,30) |





entrance mats

Promat is a modular technical mat designed for both public and private use. Thanks to its easy assembly with a simple interlocking system, Promat does not need specific expertise and can be assembled directly on site. Promat is available in three insert solutions: carpet, brushes or rubber. In this way, it guarantees the cleaning and the protection of floors against dust, filth in general and water.

promat

available from September 2022

Promat is a modular technical mat, which can be customized and created in any size directly on site, allowing maximum operational flexibility.

The installation of Promat is easy and quick thanks to the interlocking system with silver anodised aluminium profiles, already equipped with inserts in black carpet, rubber or brushes. The carpet insert, recommended for internal use, absorbs finer dirt and water, and also aids drying when passing through.

The rubber insert is resistant to atmospheric agents, making it ideal for outdoor use, removes coarse dirt and also has a non-slip function. Lastly, the brushes insert is suitable for outdoor installation in area of high pedestrian traffic thanks to its ability to remove the most difficult dirt.

Promat can be installed recessed or overlapped on existing floors according to the needs. In case of overlapping installation, there is the possibility to insert the ramp profile for facilitating the access.

Promat is also available in two already-assembled and ready-for-use versions in a choice of carpet or rubber/brush mix, in sizes 70x39,5 cm and 90x49,5 cm.



available from September 2022

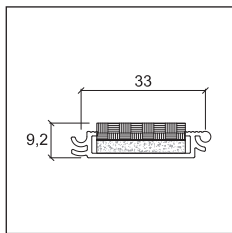

ZT/307/MN

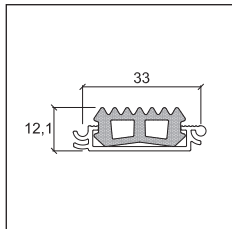

ZT/307/GN

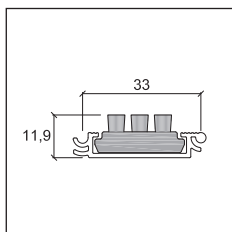

ZT/307/SN

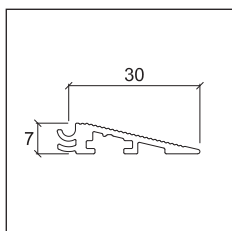

ZT/307/R1

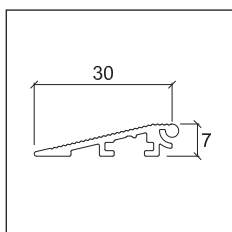

ZT/307/R2

NEW PROMAT

length = 270 cm - pack 10 pcs

| ART. | | | Conf. |
|-----------|--|-------|-------|
| ZT/307/MN | silver anodised aluminium profile + black carpet insert | 90400 | 10 |
| ZT/307/GN | silver anodised aluminium profile + black rubber insert | 90401 | 10 |
| ZT/307/SN | silver anodised aluminium profile + black brushes insert | 90402 | 10 |
| ZT/307/R1 | silver anodised aluminium right ramp profile | 90403 | 10 |
| ZT/307/R2 | silver anodised aluminium left ramp profile | 90404 | 10 |

individually packed

NEW ACCESSORIES

| ART. | | | Conf. |
|-----------|----------------------------------|-------|-------|
| ZT/307/NA | adhesive tape in black EPDM 20 m | 90405 | 1 |

no partial packaging

NEW PROMAT - READY-MADE MAT

| ART. | | | Conf. |
|-----------|--|-------|-------|
| ZT/307/01 | ready-made mat dim. 70x39,5 cm with profiles with black carpet inserts | 90407 | |
| ZT/307/02 | ready-made mat dim. 70x39,5 cm with profiles with black rubber and brushes inserts | 90408 | |
| ZT/307/03 | ready-made mat dim. 90x49,5 cm with profiles with black carpet inserts | 90409 | |
| ZT/307/04 | ready-made mat dim. 90x49,5 cm with profiles with black rubber and brushes inserts | 90410 | |

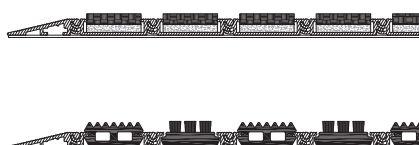





supports for raised floors

With the new supports for raised floors PP Level Duo® by Profilpas, there is the possibility to choose between fixed and self-levelling head in an instant, directly during the installation.

A choice that can be made easily, thanks to the special converter Perfect Ring. Indeed, if you insert it between the head and the screw, the support becomes fixed. On the contrary, if there is the need to compensate the slope of a surface up to 6%, it will be sufficient not to insert the ring to obtain a self-levelling system.

pp level duo® - complete support

PPlevelDUO®



- speed of installation: just 5 seconds to assemble the support.
- height adjustment from the top through adjustment key.
- adjustable supports with wide excursion of available heights.
- the solid and blunt base impedes the incision of the waterproofing membrane.
- acoustic insulation: noise-proof rubber intergated with the head.
- a system of draining holes and canalizations impedes the stagnation of water in every part of the support.
- solid support base of 340 cm² for a better distribution of the weight.
- precise adjustment of the slope to guarantee a perfect flat surface.
- usable in spaces with temperatures from - 40° C to + 80° C.
- pre-cut tabs for 2, 3 and 4 mm joints.
- ecological: all the support is made of recyclable plastic materials.
- NEW** ● stackable extension of 10 mm thickness. It allows to increase the overall height in combination with PP Level DUO or PP Level FIX, assembling two or more elements through the specific plugs.



pp level duo® - complete support



25/37/4



37/61/4



60/105/4



94/169/4



150/280/4



239/320/4



P1/10

PP LEVEL DUO® - HEAD + SCREW + BASE

head for 4-mm joints - tabs H 12 mm

| ART. | | | pack | pallet |
|------------------|--|----------------------|--------|----------|
| 25/37/4 | head + screw + base adjustable from h 25 to 37 mm | 19360 | 25 pcs | 1250 pcs |
| | <i>euro/pc (euro/pack)</i> | 3,63 (90,75) | | |
| 37/61/4 | head + screw + base adjustable from h 37 to 61 mm | 19361 | 25 pcs | 900 pcs |
| | <i>euro/pc (euro/pack)</i> | 4,65 (116,25) | | |
| 60/105/4 | head + screw + base adjustable from h 60 to 105 mm | 19362 | 25 pcs | 500 pcs |
| | <i>euro/pc (euro/pack)</i> | 4,99 (124,75) | | |
| 94/169/4 | head + screw + base adjustable from h 94 to 169 mm | 19363 | 25 pcs | 400 pcs |
| | <i>euro/pc (euro/pack)</i> | 5,46 (136,50) | | |
| 150/280/4 | head + screw + base adjustable from h 150 to 280 mm | 19364 | 25 pcs | 300 pcs |
| | <i>euro/pc (euro/pack)</i> | 6,11 (152,75) | | |
| 239/320/4 | head + screw + extension element + base adjustable from h 239 to 320 mm | 19365 | 25 pcs | 300 pcs |
| | <i>euro/pc (euro/pack)</i> | 8,79 (219,75) | | |



no partial packaging

EXTENSION FOR PP LEVEL DUO®

| ART. | | | pack | pallet |
|--------------|----------------------------|---------------------|--------|---------|
| P1/80 | extension element h 80 mm | 19380 | 25 pcs | 500 pcs |
| | <i>euro/pc (euro/pack)</i> | 3,14 (78,50) | | |
| P1/10 | extension element h 10 mm | 19369 | 15 pcs | - |
| | <i>euro/pc (euro/pack)</i> | 1,20 (18,00) | | |

NEW

no partial packaging

| | | | | | | | | | |
|---|-------|-------|-------|-------|-------|-------|-------|-------|-------|
|  | 1 pcs | 1 pcs | 1 pcs | 1 pcs | 1 pcs | 1 pcs | 1 pcs | 1 pcs | 1 pcs |
|  | 1 pcs | 2 pcs | 3 pcs | 4 pcs | 5 pcs | 6 pcs | 7 pcs | 8 pcs | 9 pcs |

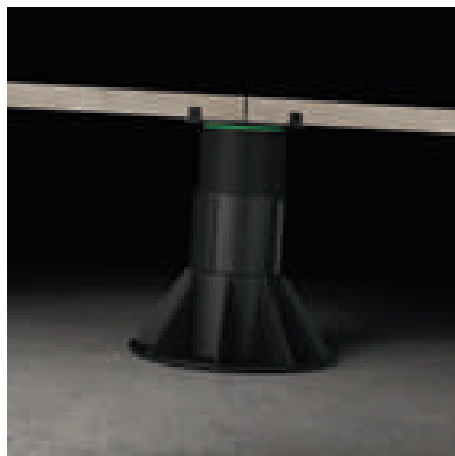

with Perfect Ring, the support is fixed



without Perfect Ring, the support is self-levelling

pp level duo® - modular support

PP level DUO® - Other heads

PP Level DUO® supports are extremely versatile thanks to the possibility to choose between different heads for ceramic tiles (with 2, 3 and 4 mm tabs) or decking. Each head can be combined with any adjustable base.

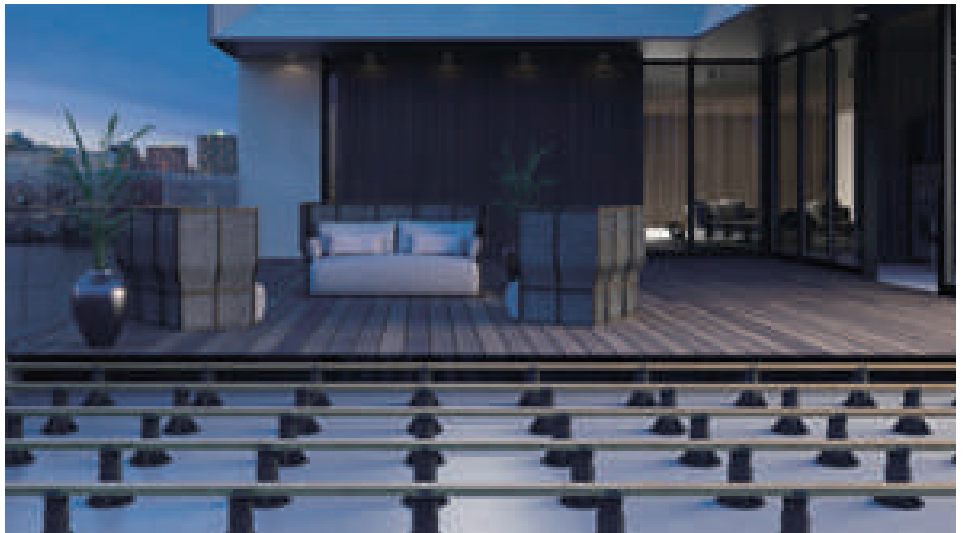

PPL/TD

PP LEVEL DUO® - HEAD FOR DECKING

| ART. | | | pack | pallet |
|---------------|----------------------------|---------------------|--------|---------|
| PPL/TD | head for decking | 19399 | 25 pcs | 500 pcs |
| | <i>euro/pc (euro/pack)</i> | 1,25 (31,25) | | |

no partial packaging



PPL/5030/T +
PPL/TD/TT

NEW PP LEVEL DUO® - JOIST FOR DECKING

length 200 cm

| ART. | | | pack | pallet |
|-------------------|--------------------------------------|-----------------------|-------|---------|
| PPL/5030/T | joist for decking section 50x30x2 mm | 19389 | 8 pcs | 160 pcs |
| | <i>euro/m (euro/pack)</i> | 13,71 (219,36) | | |

no partial packaging

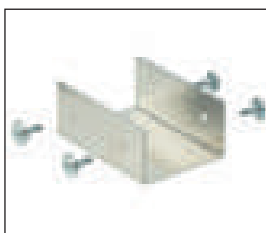

PPL/TD/GR

NEW PP LEVEL DUO® - ACCESSORIES FOR JOISTS FOR DECKING

| ART. | | | pack | pallet |
|------------------|-------------------------------------|----------------------|--------|--------|
| PPL/TD/GR | connection for joists for decking | 19387 | 12 pcs | |
| | <i>euro/pc (euro/pack)</i> | 3,43 (41,16) | | |
| PPL/TD/TT | T connection for joists for decking | 19388 | 20 pcs | |
| | <i>euro/pc (euro/pack)</i> | 5,75 (115,00) | | |

no partial packaging



PPL/TD/TT

pp level duo® - modular support

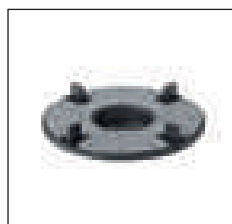

PPL/T2
PPL/T3
PPL/T4



25/37/B



37/61/B



60/105/B



94/169/B



150/280/B

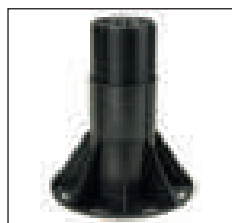

239/320/B

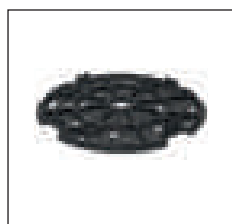

P1/10

PP LEVEL DUO® - HEAD FOR 2, 3 AND 4 MM JOINTS

| ART. | | | pack | pallet |
|---------------|----------------------------|---------------------|--------|---------|
| PPL/T2 | head for 2 mm joints | 19370 | 25 pcs | 500 pcs |
| | <i>euro/pc (euro/pack)</i> | 1,25 (31,25) | | |
| PPL/T3 | head for 3 mm joints | 19374 | 25 pcs | 500 pcs |
| | <i>euro/pc (euro/pack)</i> | 1,25 (31,25) | | |
| PPL/T4 | head for 4 mm joints | 19371 | 25 pcs | 500 pcs |
| | <i>euro/pc (euro/pack)</i> | 1,25 (31,25) | | |

no partial packaging

PP LEVEL DUO® - BASE + SCREW

| ART. | | | pack | pallet |
|------------------|--|----------------------|--------|----------|
| 25/37/B | base + screw adjustable from h 25 to 37 mm | 19390 | 25 pcs | 1250 pcs |
| | <i>euro/pc (euro/pack)</i> | 2,38 (59,50) | | |
| 37/61/B | base + screw adjustable from h 37 to 61 mm | 19391 | 25 pcs | 900 pcs |
| | <i>euro/pc (euro/pack)</i> | 3,40 (85,00) | | |
| 60/105/B | base + screw adjustable from h 60 to 105 mm | 19392 | 25 pcs | 500 pcs |
| | <i>euro/pc (euro/pack)</i> | 3,74 (93,50) | | |
| 94/169/B | base + screw adjustable from h 94 to 169 mm | 19393 | 25 pcs | 400 pcs |
| | <i>euro/pc (euro/pack)</i> | 4,22 (105,50) | | |
| 150/280/B | base + screw adjustable from h 150 to 280 mm | 19394 | 25 pcs | 300 pcs |
| | <i>euro/pc (euro/pack)</i> | 4,86 (121,50) | | |
| 239/320/B | base + screw + extension element adjustable from h 239 to 320 mm | 19395 | 25 pcs | 300 pcs |
| | <i>euro/pc (euro/pack)</i> | 7,55 (188,75) | | |

no partial packaging

EXTENSION FOR PP LEVEL DUO®

| ART. | | | pack | pallet |
|------------------|----------------------------|---------------------|--------|---------|
| P1/80 | extension element h 80 mm | 19380 | 25 pcs | 500 pcs |
| | <i>euro/pc (euro/pack)</i> | 3,14 (78,50) | | |
| NEW P1/10 | extension element h 10 mm | 19369 | 15 pcs | - |
| | <i>euro/pc (euro/pack)</i> | 1,20 (18,00) | | |

no partial packaging

| | H. 15/400 | H. 20/440 | H. 25/480 | H. 30/520 | H. 35/560 | H. 40/600 | H. 45/640 | H. 50/680 | H. 55/720 |
|---|-----------|-----------|-----------|-----------|-----------|-----------|-----------|-----------|-----------|
| art. 19380 col. 19380 P. 15/10/10 | 1 pcs | 1 pcs | 1 pcs | 1 pcs | 1 pcs | 1 pcs | 1 pcs | 1 pcs | 1 pcs |
| art. 19369 col. 19369 | 1 pcs | 2 pcs | 3 pcs | 4 pcs | 5 pcs | 6 pcs | 7 pcs | 8 pcs | 9 pcs |

For a single piece, see sales conditions on page 288

pp level duo® - double joist system



PP level DUO® - double joist system

The aluminium joists system is the ideal solution for the installation of single-format and multifomat ceramic tiles. Thanks to this system, the installation is always precise and, at the same time, guarantees great stability and resistance.

Profilpas double joist system is composed of two joists in natural aluminium that must be fixed on a special head, thus creating a rail for the positioning of the spacer. The spacer, thanks to its removable tabs, guarantees a correct position of the tiles and creates the 4-mm joint.

- the double joist system is not visible from the joint.
- the double joist system avoids water stagnation and the accumulation of dust and filth.
- thanks to the space between the two joists, it is possible to adjust the height of the support through the specific key.

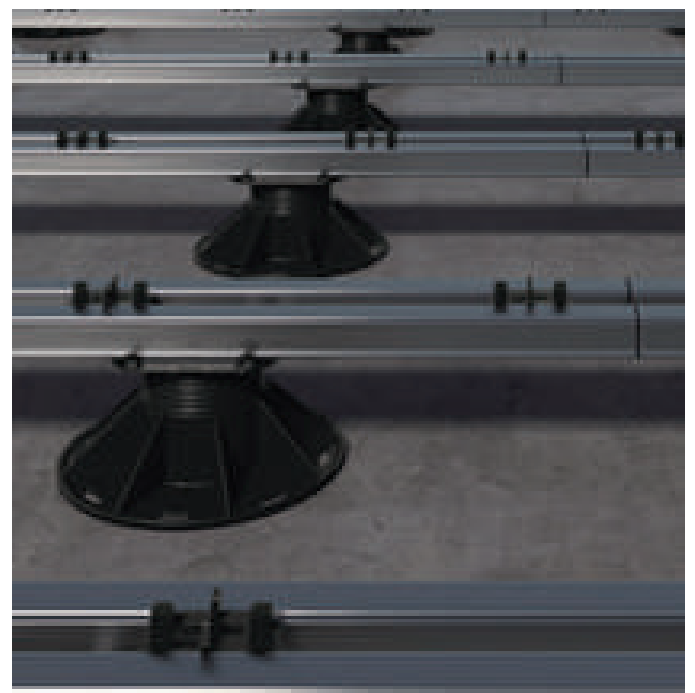

pp level duo® - double joist system

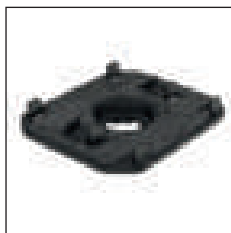

PPL/TA

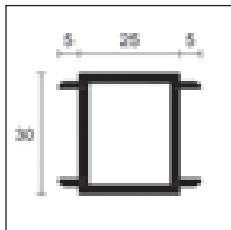

PPL/T

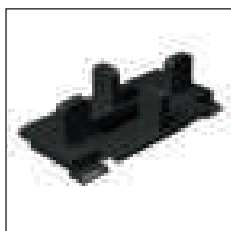

PPL/D4



PPL/GM

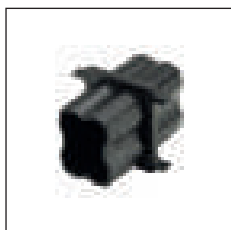

PPL/GR



PPL/TT



P1/10

PP LEVEL DUO® - HEAD AND ACCESSORIES FOR THE DOUBLE JOIST SYSTEM

| ART. | | | pack | pallet |
|-------------------|---|-----------------------|---------|---------|
| PPL/TA | head for aluminium joists | 19396 | 25 pcs | 500 pcs |
| | <i>euro/pc (euro/pc)</i> | 1,40 (35,00) | | |
| PPL/T | aluminium joist L 2000 mm | 19397 | 10 pcs | 200 pcs |
| | <i>euro/m (euro/pc)</i> | 11,69 (233,80) | | |
| PPL/D4 | 4-mm spacer for aluminium joists | 19398 | 500 pcs | - |
| | <i>euro/pc (euro/pc)</i> | 0,24 (120,00) | | |
| PPL/GM | noise-proof rubber 20x2 mm - 20 meters roll | 19372 | 5 pcs | - |
| | <i>euro/m (euro/pc)</i> | 2,32 (232,00) | | |
| PPL/GR | connection for joists | 19373 | 250 pcs | - |
| | <i>euro/pc (euro/pc)</i> | 0,36 (90,00) | | |
| NEW PPL/TT | T connection for joists | 19375 | 20 pcs | - |
| | <i>euro/pc (euro/pc)</i> | 6,73 (134,60) | | |

no partial packaging

The aluminium joists must be installed in pairs.

PP LEVEL DUO® - BASE + SCREW

| ART. | | | pack | pallet |
|------------------|--|----------------------|--------|----------|
| 25/37/B | base + screw adjustable from h 25 to 37 mm | 19390 | 25 pcs | 1250 pcs |
| | <i>euro/pc (euro/pc)</i> | 2,38 (59,50) | | |
| 37/61/B | base + screw adjustable from h 37 to 61 mm | 19391 | 25 pcs | 900 pcs |
| | <i>euro/pc (euro/pc)</i> | 3,40 (85,00) | | |
| 60/105/B | base + screw adjustable from h 60 to 105 mm | 19392 | 25 pcs | 500 pcs |
| | <i>euro/pc (euro/pc)</i> | 3,74 (93,50) | | |
| 94/169/B | base + screw adjustable from h 94 to 169 mm | 19393 | 25 pcs | 400 pcs |
| | <i>euro/pc (euro/pc)</i> | 4,22 (105,50) | | |
| 150/280/B | base + screw adjustable from h 150 to 280 mm | 19394 | 25 pcs | 300 pcs |
| | <i>euro/pc (euro/pc)</i> | 4,86 (121,50) | | |
| 239/320/B | base + screw + extension element adjustable from h 239 to 320 mm | 19395 | 25 pcs | 300 pcs |
| | <i>euro/pc (euro/pc)</i> | 7,55 (188,75) | | |

no partial packaging

EXTENSION FOR PP LEVEL DUO®

| ART. | | | pack | pallet |
|------------------|---------------------------|---------------------|--------|---------|
| P1/80 | extension element h 80 mm | 19380 | 25 pcs | 500 pcs |
| | <i>euro/pc (euro/pc)</i> | 3,14 (78,50) | | |
| NEW P1/10 | extension element h 10 mm | 19369 | 15 pcs | - |
| | <i>euro/pc (euro/pc)</i> | 1,20 (18,00) | | |

no partial packaging

| | h. 110/400 | h. 200/400 | h. 270/400 | h. 350/400 | h. 420/400 | h. 500/400 | h. 580/400 | h. 660/400 | h. 800/400 |
|--|------------|------------|------------|------------|------------|------------|------------|------------|------------|
| art. 239/320/B cod. 19395 + base + screw | 1 pcs | 1 pcs | 1 pcs | 1 pcs | 1 pcs | 1 pcs | 1 pcs | 1 pcs | 1 pcs |
| art. P1/10 cod. 19369 | 1 pcs | 2 pcs | 3 pcs | 4 pcs | 5 pcs | 6 pcs | 7 pcs | 8 pcs | 9 pcs |

pp level fix - complete support

PP Level FIX is a new line of supports with fixed head. Available for heights from 25 to 280 mm, PP Level Fix supports can be adjusted in height from the top, thanks to the specific adjustment key.



PP Level Fix

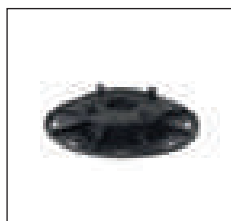

25/37/4F



37/61/4F



60/105/4F



94/169/4F



150/280/4F

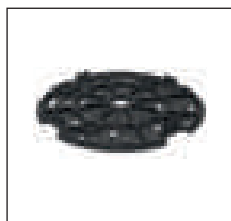

P1/10

PP LEVEL FIX

head for 4-mm joints - tabs h 12 mm

| ART. | | | pack | pallet |
|-------------------|---|----------------------|--------|----------|
| 25/37/4F | head + screw + base adjustable from h 25 to 37 mm | 19340 | 25 pcs | 1250 pcs |
| | <i>euro/pc (euro/pack)</i> | 2,67 (66,75) | | |
| 37/61/4F | head + screw + base adjustable from h 37 to 61 mm | 19341 | 25 pcs | 900 pcs |
| | <i>euro/pc (euro/pack)</i> | 3,56 (89,00) | | |
| 60/105/4F | head + screw + base adjustable from h 60 to 105 mm | 19342 | 25 pcs | 500 pcs |
| | <i>euro/pc (euro/pack)</i> | 3,78 (94,50) | | |
| 94/169/4F | head + screw + base adjustable from h 94 to 169 mm | 19343 | 25 pcs | 400 pcs |
| | <i>euro/pc (euro/pack)</i> | 4,23 (105,75) | | |
| 150/280/4F | head + screw + base adjustable from h 150 to 280 mm | 19344 | 25 pcs | 300 pcs |
| | <i>euro/pc (euro/pack)</i> | 4,79 (119,75) | | |

no partial packaging

EXTENSION FOR PP LEVEL FIX

| ART. | | | pack | pallet |
|------------------|----------------------------|---------------------|--------|--------|
| NEW P1/10 | extension element h 10 mm | 19369 | 15 pcs | - |
| | <i>euro/pc (euro/pack)</i> | 1,20 (18,00) | | |

no partial packaging

PP Level Mini is a support with fixed head, for heights from 10 to 15 mm. With maximum two extension elements P/5, there is the possibility to reach an height of 25 mm.



PP Level Mini



10/15



P/5

PP LEVEL MINI

head for 4-mm joints - tabs h 10 mm

| ART. | | pack | |
|--------------|--|---------------------|--------|
| 10/15 | adjustable support from h 10 to 15 mm | 19351 | 20 pcs |
| | <i>euro/pc (euro/pack)</i> | 1,72 (34,40) | |
| P/5 | extension element of 5 mm thickness for art. 10/15 (maximum two elements = +10 mm) | 19350 | 20 pcs |
| | <i>euro/pc (euro/pack)</i> | 0,81 (16,20) | |

no partial packaging

SP1 is a support to be used for the positioning of grit and concrete slabs. It can be installed with the correctors SP2 and SP3, according to the desired slope of the flooring. SP1 guarantees the outflow of rainwater and allows to avoid the direct contact of the flooring with the possible waterproofing layer.



SP1

SUPPORT FOR RAISED FLOORS

pack 360 pcs

| ART. | | pack | pallet |
|------------|--|----------------------|----------|
| SP1 | support for grit and concrete slabs diam. 155x14 h | 19090 | 360 pcs |
| | <i>euro/pc (euro/pack)</i> | 0,207 (74,19) | 5760 pcs |

no partial packaging

CORRECTORS FOR RAISED FLOORS

pack 1000 pcs

| ART. | | pack | pallet |
|------------|--|-----------------------|-----------|
| SP2 | corrector for support SP1 thickness 1 mm | 19092 | 1000 pcs |
| | <i>euro/pc (euro/pack)</i> | 0,204 (203,68) | 20000 pcs |

pack 500 pcs

| ART. | | pack | pallet |
|------------|--|-----------------------|-----------|
| SP3 | corrector for support SP1 thickness 3 mm | 19093 | 500 pcs |
| | <i>euro/pc (euro/pack)</i> | 0,215 (107,40) | 15000 pcs |

no partial packaging



SP2

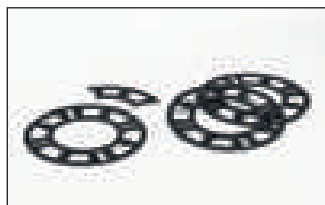

SP3

pp level duo® - accessori

Among the accessories for the installation of outdoor raised floors, in addition to the adjustment key, there are rubber disks, levelling disks and a full system for the creation of steps and vertical risers. PCC/01, PCC/04 and PCC/02 are stainless steel clips to be installed on the head and under the base of perimetral and corner supports: the tile must be positioned between the two clips in order to create a perfect step. This result can be also obtained with PCC/03 and PCC/05, two clips for the installation close to vertical walls that allows to keep always the same distance between the wall and the tiles.



PCC/01 and PCC/02 stainless steel clips

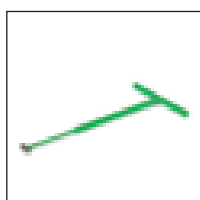

CR/N

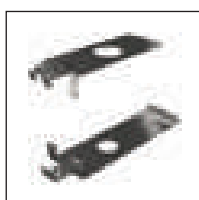

KIT PCC/01

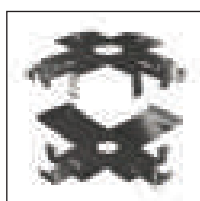

KIT PCC/02

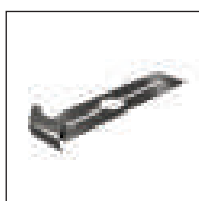

PCC/03

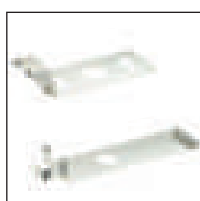

PCC/04

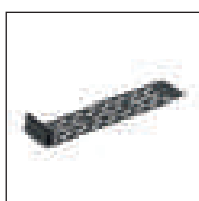

PCC/05



PPL/S



PPL/DLT

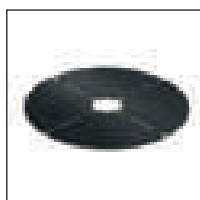

PPL/DLB

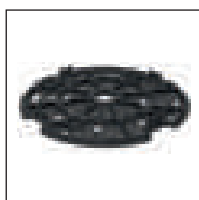

P1/10

PP LEVEL DUO® AND PP LEVEL FIX ACCESSORIES

| ART. | | | pack | |
|----------------|---|------------|-----------------------|---------|
| CR/N | adjustment key (for 4 mm joints) | | 19381 | 12 pcs |
| | <i>euro/pc</i> | | 31,34 | |
| PCC/01 | perimetral clip (base + head) | | 19382 | 30 Kit |
| | <i>euro/kit (euro/pack)</i> | | 14,45 (433,50) | |
| PCC/02 | corner clip (base + head) | | 19383 | 4 Kit |
| | <i>euro/kit (euro/pack)</i> | | 33,80 (135,20) | |
| PCC/03 | wall clip | | 19384 | 50 pcs |
| | <i>euro/kit (euro/pack)</i> | | 3,55 (177,50) | |
| PCC/04 | clips for joists (base + head) | NEW | 19386 | 30 Kit |
| | <i>euro/kit (euro/pack)</i> | | 15,17 (455,10) | |
| PCC/05 | wall clip in black polypropylene | NEW | 19377 | 200 pcs |
| | <i>euro/pc (euro/pack)</i> | | 0,95 (190,00) | |
| PPL/S | rubber disk diameter 21 cm x thickness 0,2 cm | NEW | 19385 | 100 pcs |
| | <i>euro/pc (euro/pack)</i> | | 1,01 (101,00) | |
| PPL/DLT | levelling disk for head diameter cm 12 x thickness 0,2 cm | NEW | 19378 | 100 pcs |
| | <i>euro/pc (euro/pack)</i> | | 0,93 (93,00) | |
| PPL/DLB | levelling disk for base diameter cm 21 x thickness 0,2 cm | NEW | 19379 | 100 pcs |
| | <i>euro/pc (euro/pack)</i> | | 1,40 (140,00) | |

no partial packaging (except for CR/N)

EXTENSION FOR PP LEVEL DUO® AND PP LEVEL FIX

| ART. | | | pack | pallet |
|--------------|----------------------------|------------|---------------------|--------|
| P1/10 | extension element h 10 mm | NEW | 19369 | 15 pcs |
| | <i>euro/pc (euro/pack)</i> | | 1,20 (18,00) | |

no partial packaging



For a single piece, see sales conditions on page 288

Protec CPLV is a line of perimetral profiles in colour-coated aluminium, for the protection and finishing of the borders of outdoor raised floors, terraces or balconies. They are composed of a drilled base CPLB to be screwed to the supports, or, as an alternative, a cut base CPLB/2 for glued tiles, and a visible profile to be fixed with adhesive, available in 3 different heights according to the floor thickness. There are also special accessories for the creation of external corners and junctions.



CPLB + CPLV/60 ash grey RAL 7038 colour-coated aluminium

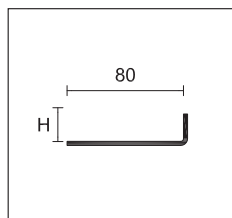
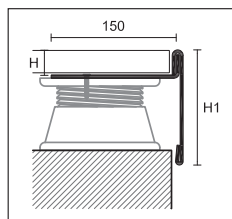

CPLB
base for raised
floors

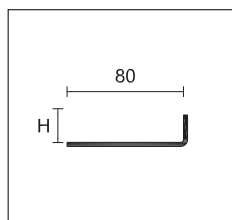

CPLB/2
punched base for
tiled floors

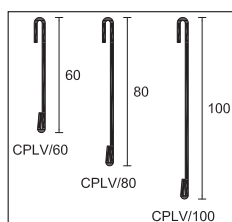

CPLV/

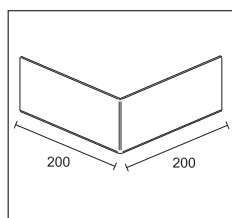

CPLV / E

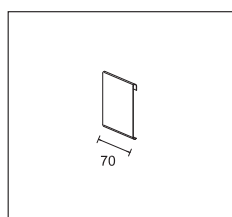

CPLV / G

PROTEC

length = 270 cm - pack 10 pcs **H**

BASE

ART. finishing 20

ALUMINIUM

| | | | |
|-------------------|-------------------|--|--------------|
| CPLB | natural aluminium | | 86900 |
| | <i>euro/m</i> | | 21,40 |
| NEW CPLB/2 | natural aluminium | | 86901 |
| | <i>euro/m</i> | | 11,64 |

CPLB with draining holes available on request, extra euro/m 2,71
CPLB and CPLB/2 in 15 and 25 mm height available on request
possibility to choose noise-proof rubber PPL/GM, see page 253

PROTEC

length = 270 cm - pack 10 pcs **H1**

FRONT

ART. finishing 60 80 100

COLOUR-COATED ALUMINIUM

| | | | | | |
|--------------|-------------------|--|--------------|--------------|--------------|
| CPLV/ | ash grey RAL 7038 | | 86902 | 86904 | 86906 |
| | ancient grey | | 86903 | 86905 | 86907 |
| | stone | | 86908 | 86909 | 86910 |
| | greige | | 86911 | 86912 | 86913 |
| | sand | | 86914 | 86915 | 86916 |
| | beige | | 86917 | 86918 | 86919 |
| | <i>euro/m</i> | | 15,86 | 18,38 | 20,75 |

white RAL 9003, dark brown RAL 8019, metal grey RAL 9006, aluminium grey RAL 9007, ash grey RAL 7038 embossed and rust with a minimum of 270 meters, on request, without surcharge. For other colours please contact our sales department.

OUTSIDE CORNER A 90°

pack 5 pcs **H1**

ART. finishing 60 80 100

COLOUR-COATED ALUMINIUM

| | | | | | |
|-----------------|-------------------|--|--------------|--------------|--------------|
| CPLV / E | ash grey RAL 7038 | | 86920 | 86922 | 86924 |
| | ancient grey | | 86921 | 86923 | 86925 |
| | stone | | 86926 | 86927 | 86928 |
| | greige | | 86929 | 86931 | 86933 |
| | sand | | 86935 | 86936 | 86937 |
| | beige | | 86938 | 86939 | 86940 |
| | <i>euro/pc</i> | | 26,95 | 26,95 | 26,95 |

NEW JUNCTION

width = 70 mm - pack 5 pcs **H1**

ART. finishing 60 80 100

COLOUR-COATED ALUMINIUM

| | | | | | |
|-----------------|-------------------|--|-------------|-------------|-------------|
| CPLV / G | ash grey RAL 7038 | | 86930 | 86932 | 86934 |
| | ancient grey | | 86941 | 86942 | 86943 |
| | stone | | 86944 | 86945 | 86946 |
| | greige | | 86947 | 86948 | 86949 |
| | sand | | 86950 | 86951 | 86952 |
| | beige | | 86953 | 86954 | 86955 |
| | <i>euro/pc</i> | | 5,46 | 5,46 | 5,46 |

no partial packaging

For a single piece, see sales conditions on page 288



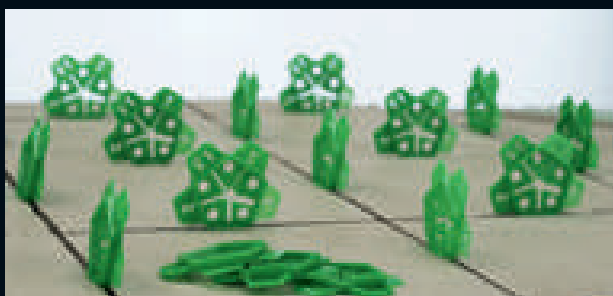
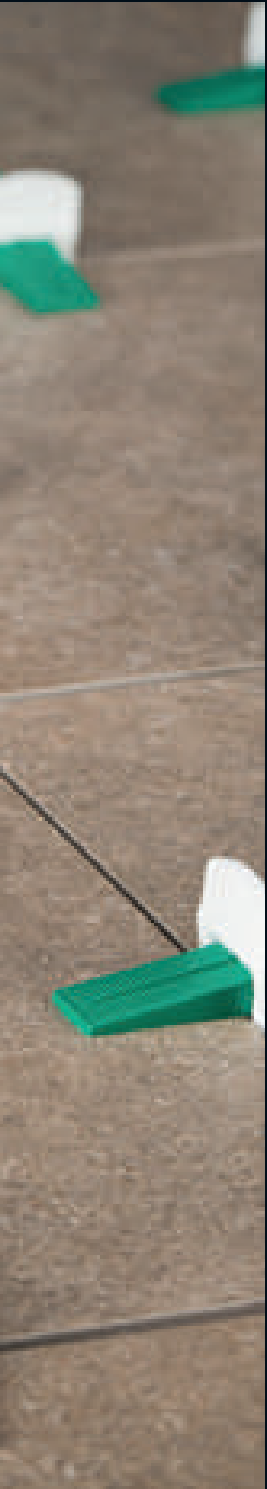

accessories for installation

Levelling systems for
tiles installation, spacers,
adhesives, utensils, systems
and accessories.

Protiler is a levelling system for the laying of ceramic and stone tiles. It is suitable for thicknesses from 3 to 20 mm and impedes the vertical movement between tiles during the adhesive grip phase. Specific pliers are available for the laying of floors and coverings for less effort and saving time.



Protiler



disposable clips installation



tiles laying

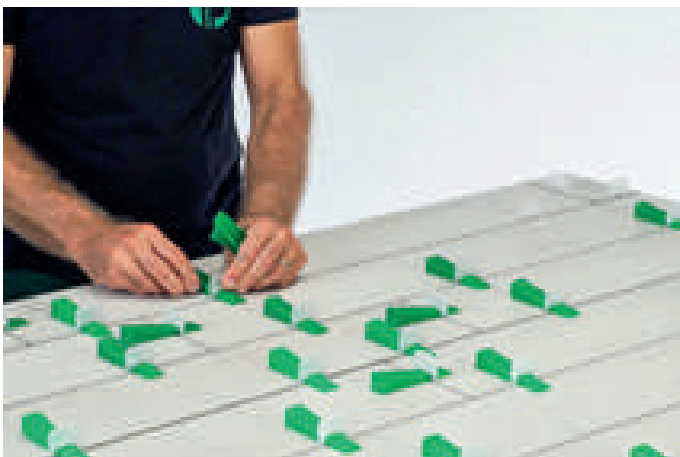

levelling wedges insertion



wedges and clips removal



PTLN

PROTILER

pack 10 pcs

ART.

| | | | |
|-------------|--|-------|----------------|
| PTLN | adjustable traction pliers <i>euro/pc (euro/pack)</i> | 18067 | 20,50 (205,00) |
|-------------|--|-------|----------------|

no partial packaging

LEVELLING WEDGES

pack 14 bags with 100 pcs

pallet

ART.

| | | | | |
|-------------|---|-------|----------|--------------|
| PTWN | levelling wedges <i>euro/pc (euro/bag)</i> | 18063 | 210 bags | 0,095 (9,50) |
|-------------|---|-------|----------|--------------|

NEW

pack 1400 pcs

pallet

ART.

| | | | | |
|------------------|--|-------|----------|----------------|
| PTWN/1400 | levelling wedges <i>euro/pc (euro/pack)</i> | 18076 | 15 packs | 0,086 (120,00) |
|------------------|--|-------|----------|----------------|

no partial packaging

DISPOSABLE CLIPS

pack 12 bags with 250 pcs

pallet

ART.

| | | | | |
|--------------|--|-------|----------|----------------|
| PTC | clips for 0,5 mm grouts and tile thicknesses from 3 to 12 <i>euro/pc (euro/bag)</i> | 18070 | 180 bags | 0,0496 (12,40) |
| PTC1 | clips for 1 mm grouts and tile thicknesses from 3 to 12 <i>euro/pc (euro/bag)</i> | 18071 | 180 bags | 0,0496 (12,40) |
| PTC1A | clips for 1,5 mm grouts and tile thicknesses from 3 to 12 <i>euro/pc (euro/bag)</i> | 18075 | 180 bags | 0,0496 (12,40) |
| PTC2 | clips for 2 mm grouts and tile thicknesses from 3 to 12 <i>euro/pc (euro/bag)</i> | 18072 | 180 bags | 0,0496 (12,40) |
| PTC3 | clips for 3 mm grouts and tile thicknesses from 3 to 12 <i>euro/pc (euro/bag)</i> | 18073 | 180 bags | 0,0496 (12,40) |

pack 60 bags with 50 pcs

pallet

ART.

| | | | | |
|-------------|--|-------|----------|--------------|
| PTC4 | clips for 2 mm grouts and tile thicknesses from 12 to 20 mm <i>euro/pc (euro/bag)</i> | 18074 | 600 bags | 0,076 (3,80) |
|-------------|--|-------|----------|--------------|

NEW

pack 3000 pcs

pallet

ART.

| | | | | |
|-------------------|---|-------|----------|----------------|
| PTC/3000 | clips for 0,5 mm grouts and tile thicknesses from 3 to 12 <i>euro/pc (euro/pack)</i> | 18077 | 15 packs | 0,044 (132,00) |
| PTC1/3000 | clips for 1 mm grouts and tile thicknesses from 3 to 12 <i>euro/pc (euro/pack)</i> | 18078 | 15 packs | 0,044 (132,00) |
| PTC1A/3000 | clips for 1,5 mm grouts and tile thicknesses from 3 to 12 <i>euro/pc (euro/pack)</i> | 18079 | 15 packs | 0,044 (132,00) |
| PTC2/3000 | clips for 2 mm grouts and tile thicknesses from 3 to 12 <i>euro/pc (euro/pack)</i> | 18080 | 15 packs | 0,044 (132,00) |
| PTC3/3000 | clips for 3 mm grouts and tile thicknesses from 3 to 12 <i>euro/pc (euro/pack)</i> | 18081 | 15 packs | 0,044 (132,00) |

no partial packaging

NEW

BUCKET

pack 15 pcs

ART.

pack

| | | | | |
|------------|--|-------|--------|---------------|
| PTS | 9.1 L bucket for accessories dim. cm 28x19x23 h. <i>euro/pc (euro/pack)</i> | 18069 | 15 pcs | 8,07 (121,05) |
|------------|--|-------|--------|---------------|

no partial packaging



PTS

Fix Level is a screw levelling system for floors and coverings of different thickness, particularly suitable for large size tiles.

The cylinder incorporates a disk for the protection of the covering surface against scratches during the levelling phase.



Fix Level



FL/C

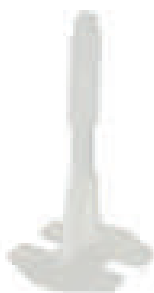

KL/1
KL/1A
KL/2
KL/3

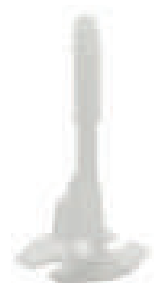

KL/T1
KL/T2
KL/T3



KL/X1
KL/X2
KL/X3



SFL

CYLINDER WITH ANTI-SCRATCH DISK

pack 10 bags with 50 pcs

ART.

| | | |
|-------------|---------------------------|-----------------------|
| FL/C | cylinder | 18027 |
| | <i>euro/pc (euro/bag)</i> | 0,5566 (27,83) |

no partial packaging

DISPOSABLE SCREW SPACER

pack 30 bags with 100 pcs

ART.

| | | |
|--------------|--|-----------------------|
| KL/1 | screw for 1-mm grouts and tile thicknesses from 3 to 20 mm | 18016 |
| | <i>euro/pc (euro/bag)</i> | 0,1113 (11,13) |
| KL/1A | screw for 1,5-mm grouts and tile thicknesses from 3 to 20 mm | 18019 |
| | <i>euro/pc (euro/bag)</i> | 0,1113 (11,13) |
| KL/2 | screw for 2-mm grouts and tile thicknesses from 3 to 20 mm | 18017 |
| | <i>euro/pc (euro/bag)</i> | 0,1113 (11,13) |
| KL/3 | screw for 3-mm grouts and tile thicknesses from 3 to 20 mm | 18018 |
| | <i>euro/pc (euro/bag)</i> | 0,1113 (11,13) |

no partial packaging

NEW DISPOSABLE T-SCREW SPACER

pack 30 bags with 100 pcs

ART.

| | | |
|--------------|--|-----------------------|
| KL/T1 | T-screw for 1-mm grouts and tile thicknesses from 3 to 20 mm | 18020 |
| | <i>euro/pc (euro/bag)</i> | 0,1113 (11,13) |
| KL/T2 | T-screw for 2-mm grouts and tile thicknesses from 3 to 20 mm | 18021 |
| | <i>euro/pc (euro/bag)</i> | 0,1113 (11,13) |
| KL/T3 | T-screw for 3-mm grouts and tile thicknesses from 3 to 20 mm | 18022 |
| | <i>euro/pc (euro/bag)</i> | 0,1113 (11,13) |

no partial packaging

NEW DISPOSABLE CROSS SCREW SPACER

pack 30 bags with 100 pcs

ART.

| | | |
|--------------|--|-----------------------|
| KL/X1 | cross screw for 1-mm grouts and tile thicknesses from 3 to 20 mm | 18023 |
| | <i>euro/pc (euro/bag)</i> | 0,1113 (11,13) |
| KL/X2 | cross screw for 2-mm grouts and tile thicknesses from 3 to 20 mm | 18024 |
| | <i>euro/pc (euro/bag)</i> | 0,1113 (11,13) |
| KL/X3 | cross screw for 3-mm grouts and tile thicknesses from 3 to 20 mm | 18025 |
| | <i>euro/pc (euro/bag)</i> | 0,1113 (11,13) |

no partial packaging

UNSCREWER FOR FIX LEVEL

pack 50 pcs

ART.

| | | |
|------------|----------------------------|-----------------------|
| SFL | unscrewer for Fix Level | 18013 |
| | <i>euro/pc (euro/pack)</i> | 0,7902 (39,51) |

no partial packaging

For a single piece, see sales conditions on page 288

Klic Level is a screw levelling system for floors and coverings of different thickness, particularly suitable for large size tiles. The cylinder incorporates a disk for the protection of the covering surface against scratches during the levelling phase, and a functional mechanism for a rapid insertion and expulsion of the disposable element.



Klic Level



KL/C

CYLINDER WITH ANTI-SCRATCH DISK

pack 10 bags with 50 pcs

ART.

| | | |
|-------------|---------------------------|-----------------------|
| KL/C | cylinder | 18015 |
| | <i>euro/pc (euro/bag)</i> | 0,7012 (35,06) |

no partial packaging

DISPOSABLE SCREW SPACER

pack 30 bags with 100 pcs

ART.

| | | |
|--------------|--|-----------------------|
| KL/1 | screw for 1-mm grouts and tile thicknesses from 3 to 20 mm | 18016 |
| | <i>euro/pc (euro/bag)</i> | 0,1113 (11,13) |
| KL/1A | screw for 1,5-mm grouts and tile thicknesses from 3 to 20 mm | 18019 |
| | <i>euro/pc (euro/bag)</i> | 0,1113 (11,13) |
| KL/2 | screw for 2-mm grouts and tile thicknesses from 3 to 20 mm | 18017 |
| | <i>euro/pc (euro/bag)</i> | 0,1113 (11,13) |
| KL/3 | screw for 3-mm grouts and tile thicknesses from 3 to 20 mm | 18018 |
| | <i>euro/pc (euro/bag)</i> | 0,1113 (11,13) |

no partial packaging

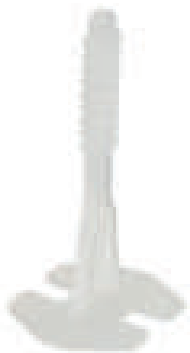

KL/1
KL/1A
KL/2
KL/3

CROSS SPACER FOR OUTDOOR USE

pack 2 bags with 50 pcs

ART.

| | | |
|-------------|--|-----------------------|
| DCE4 | cross spacer for outdoor tiles and 4-mm grouts | 19076 |
| | <i>euro/pc (euro/bag)</i> | 0,5076 (25,38) |

no partial packaging



DCE4

Spacer FIVE is a multi-thickness spacer for tiles: just one product for creating different grout spacing of 0,5 - 1 - 1,5 - 2 - 3 mm. The spacer can be used for laying both floors and wall coverings and complies with the regulation UNI 11493-1 since it has been designed to be easily removed and to be used more times. Five Spacer DF guarantees a perfect, quick and cheap laying.



spacer FIVE

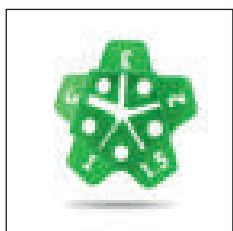

DF

SPACER FIVE

pack 20 bags with 200 pcs

ART.

DF spacer for tiles

19077

euro/pc (euro/bag)

0,0717 (14,34)

no partial packaging



Five bag

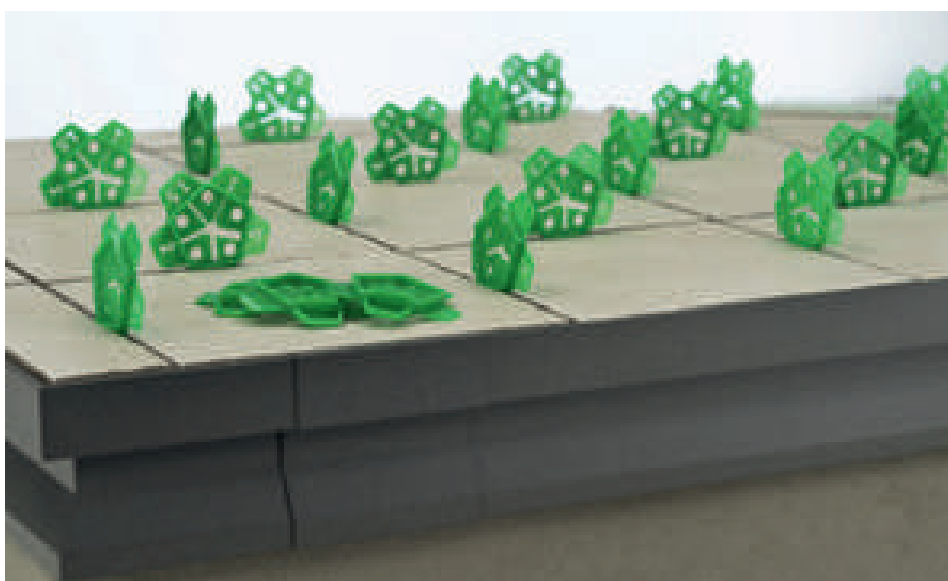

spacer FIVE

Plastic cross and T spacers used in the installation of floors and wall coverings for creating uniform and precise grout lines. They are available for thicknesses up to 10 mm and are suitable for both inside and outside spaces. Both spacers are compliant with UNI 11493-1 standard (methods for the correct installation of ceramic tiles).

Plastic wedges used for recovering small differences in height during tile installation.



Cross spacers

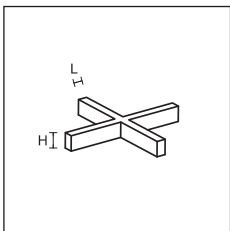

DC

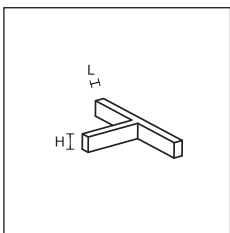

DT

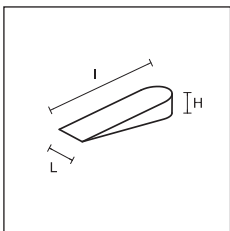

CN

CROSS SPACERS

| LxH | box with 10 packs of 500 pcs | | | | | box with 20 packs of 250 pcs | |
|------------------|------------------------------|-------------|-------------|-------------|-------------|------------------------------|--------------|
| | 1x5 | 2x5 | 3x5 | 4x5 | 5x5 | 7x6 | 10x8 |
| ART. | DC1 solid | DC2 solid | DC3 drilled | DC4 drilled | DC5 drilled | DC7 drilled | DC10 drilled |
| | 18992 | 19002 | 19008 | 19014 | 19020 | 19024 | 19030 |
| euro/pack | 3,92 | 3,92 | 4,52 | 4,69 | 5,01 | 4,37 | 7,39 |

no partial packaging

T SPACERS

| LxH | box with 10 packs of 500 pcs | | | | | box with 20 packs of 250 pcs | |
|------------------|------------------------------|-------------|-------------|-------------|-------------|------------------------------|--------------|
| | 1x5 | 2x5 | 3x5 | 4x5 | 5x5 | 7x6 | 10x8 |
| ART. | DT1 solid | DT2 solid | DT3 drilled | DT4 drilled | DT5 drilled | DT7 drilled | DT10 drilled |
| | 19038 | 19042 | 19048 | 19054 | 19060 | 19064 | 19070 |
| euro/pack | 3,92 | 3,92 | 4,52 | 4,69 | 5,01 | 4,37 | 7,39 |

no partial packaging

WEDGES

| pack | box with 20 packs of 250 pcs | box with 10 packs of 500 pcs |
|------------------|------------------------------|------------------------------|
| LxH | 9x28x5 | 9x28x5 |
| ART. | CN28 | CN28 |
| | 19080 | 19082 |
| euro/pack | 2,54 | 4,50 |

no partial packaging



T Spacers



Wedges

For a single piece, see sales conditions on page 288



skirting board adhesive

MS POLYMER-BASED ADHESIVE FOR SKIRTING BOARDS

pack 24 pcs - quantity 290 ml

| | |
|----------------|--------------|
| PP/96 | 78301 |
| euro/pc | 18,81 |

output 10/15 m for cartridge



polishing paste

MAGNETIC KIT

box with 10 blisters

| | |
|---------------------|--------------|
| K10 | 00410 |
| euro/blister | 12,59 |

POLISHING PASTE FOR METAL PROFILE CLEANING

pack 20 pcs - quantity 150 ml

| | |
|------------------------|--------------|
| POLISHING PASTE | 30018 |
| euro/pc | 31,85 |



doubled sided adhesive tapes

DOUBLED SIDED ADHESIVE TAPES

| | POLYPROPYLENE | COTTON CLOTH |
|----------------|---------------|--------------|
| pack | 24 | 24 |
| LxL cm | 5x2500 | 5x2500 |
| ART. | D/4461/K | D/4471/K |
| | 30004 | 30014 |
| euro/pc | 8,04 | 11,78 |



SCREWS

| | FLAT HEAD | | | | ROUND HEAD | |
|-----------------|---------------|--------------|---------------|---------------|---------------|--------------|
| box - 1000 pcs | | | | | | |
| finishing | nickel-plated | brass plated | bronze plated | brass plated | nickel-plated | brass plated |
| LxL mm | 3X25 | 3X25 | 3X25 | 3X25 | 3,5X25 | 3,5X25 |
| ART. | SS/5 | SS/5 | SS/5 | RR/5 | SS/4 | SS/4 |
| | 68800 | 68801 | 68802 | 68803 | 68804 | 68805 |
| euro/box | 85,02 | 85,02 | 85,02 | 190,72 | 85,02 | 85,02 |

Proflex machine is a machine designed and built to model the profiles with curvilinear shape of the proflex line produced by Profilpas. The machine contains a proper kit and more kits are available in case you need to bend the PLAF or Metal Line 90.



PROFLEX MACHINE - hand machine to bend proflex line profiles

PROFLEX MACHINE

| ART. | description | |
|----------------|---|---------------|
| proflex | hand machine to bend profiles inside and outside | 30022 |
| | <i>euro/pc</i> | 724,36 |
| 30046 | wheels kit with perforated side on the outside for PLAF | 30046 |
| | <i>euro/pc</i> | 316,90 |
| 30049 | wheels kit with perforated side on the inside for PLAF | 30049 |
| | <i>euro/pc</i> | 342,78 |
| 30052 | wheels kit for metal line flex 90/ | 30052 |
| | <i>euro/pc</i> | 858,41 |



kit 30046



kit 30049



kit 30052

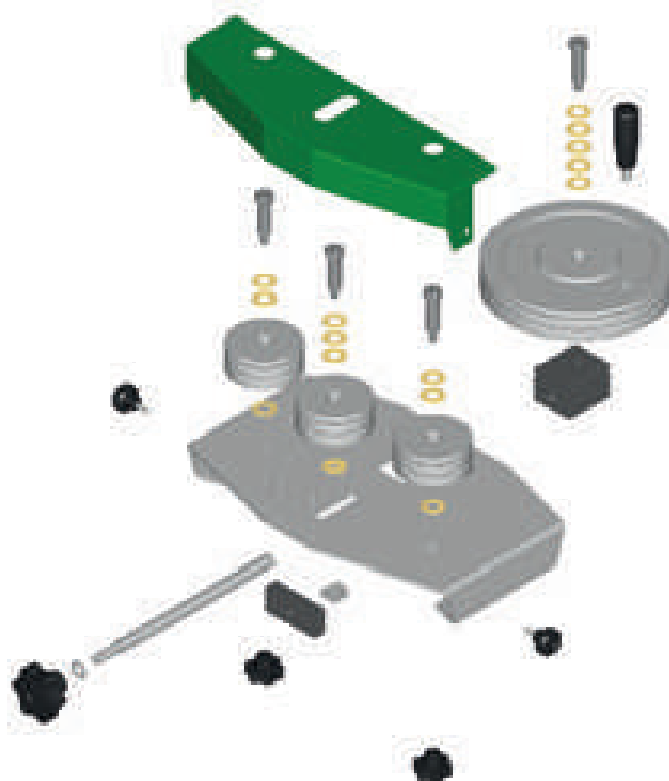









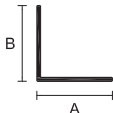
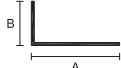

DIY profiles

A wide range of DIY profiles in aluminium, stainless steel and brass, available in many measures. Suitable to solve professional and bricolage works.



profiles in anodised aluminium

| | | with barcode label | | | |
|---|-----------|--------------------|---------|-------------|---------|
| | | length m. 1 | | length m. 2 | |
| | measures | silver | euro/pc | silver | euro/pc |
| flat  | 12x2 | 10100 | 2,04 | 10104 | 3,73 |
| | 15x2 | 10108 | 2,35 | 10112 | 4,40 |
| | 20x2 | 10116 | 2,64 | 10120 | 4,92 |
| | 25x2 | 10124 | 2,94 | 10128 | 5,59 |
| | 30x2 | 10132 | 3,36 | 10136 | 6,38 |
| | 40x2 | - | - | - | - |
| | 50x2 | - | - | - | - |
| | 60x2 | - | - | - | - |
| corner  | 10x10x1 | 10140 | 2,04 | 10144 | 3,73 |
| | 15x15x1 | 10148 | 2,23 | 10152 | 4,16 |
| | 20x20x1* | 10156 | 2,68 | 10160 | 5,02 |
| | 25x25x1* | 10164 | 2,94 | 10168 | 5,59 |
| | 30x30x1* | 10172 | 3,24 | 10176 | 6,13 |
| | 30x30x1,5 | - | - | 09020 | 8,57 |
| | 40x40x1,5 | 10380 | 5,70 | 10384 | 11,08 |
| | 40x40x2 | - | - | - | - |
| | 50x50x2 | - | - | - | - |
| corner L  | 15x10x1 | 10180 | 2,06 | 10184 | 3,78 |
| | 20x10x1 | 10188 | 2,18 | 10192 | 4,04 |
| | 30x15x1 | 10196 | 2,73 | 10200 | 5,13 |
| U profile  | 8x8x1 | 10204 | 1,92 | 10208 | 3,49 |
| | 10x10x1 | 10212 | 2,18 | 10216 | 4,04 |
| | 10x15x1 | 10220 | 2,64 | 10224 | 4,92 |
| | 12x12x1 | - | - | 10218 | 4,92 |
| double U profile  | 16x7x1 | - | - | 10232 | 4,53 |
| | 16x12x1 | 10236 | 3,00 | 10240 | 5,70 |
| | 20x10x1 | - | - | 10248 | 5,70 |
| | 20x18x1 | 10252 | 3,87 | 10256 | 7,41 |
| edge trim  | 18x1 | 10260 | 2,25 | 10264 | 4,17 |
| | 22x1 | 10268 | 2,35 | 10272 | 4,40 |
| | 25x1 | 10276 | 2,42 | 10280 | 4,53 |
| round tube  | 8x1 | 09032 | 2,10 | 09036 | 3,89 |
| | 10x1 | 09040 | 2,29 | 09044 | 4,26 |
| | 12x1 | 09048 | 2,55 | 09052 | 4,75 |
| | 15x1 | 10284 | 2,73 | 10288 | 5,13 |
| | 18x1 | 10292 | 3,06 | 10296 | 5,82 |
| | 20x1 | 10300 | 3,38 | 10304 | 6,43 |
| | 25x1,5 | - | - | 09060 | 10,42 |
| square tube  | 10x10x1 | 10308 | 2,68 | 10312 | 5,02 |
| | 15x15x1 | 10316 | 3,47 | 10320 | 6,58 |
| | 20x20x1 | 10324 | 4,23 | 10328 | 8,15 |
| rectangular tube  | 20x10x1 | 10332 | 3,47 | 10336 | 6,58 |
| | 30x15x1 | 10340 | 4,34 | 10344 | 8,36 |
| T profile  | 15x15x1,5 | 10348 | 2,78 | 10352 | 5,24 |
| | 25x25x1,5 | 10356 | 3,87 | 10360 | 7,40 |
| round bar  | Ø 6 | - | - | 09084 | 4,53 |
| | Ø 8 | 10364 | 3,17 | 10368 | 6,02 |
| | Ø 10 | - | - | 09092 | 8,37 |
| square bar  | 8x8 | 10372 | 3,74 | 10376 | 7,19 |
| | 10x10 | - | - | 10394 | 10,31 |

Articles no partial packaging. Pack. 10 pcs per item - Minimum order : 100 assorted pcs DIY range.







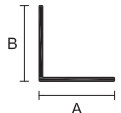
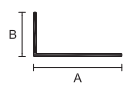
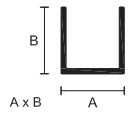

* items available also 3 m long without barcode pag 271

For a single piece, see sales conditions on page 288

EAN 13 = the first group product code

example code 10395 = 8010937 10395

profiles in anodised aluminium

| | | without barcode label | | | |
|---|-----------|-----------------------|---------|-------------|---------|
| | | length m. 2 | | length m. 3 | |
| | | silver | euro/pc | silver | euro/pc |
| flat  | measures | | | | |
| | 12x2 | 510104 | 3,43 | - | - |
| | 15x2 | 510112 | 4,12 | - | - |
| | 20x2 | 510120 | 4,62 | - | - |
| | 25x2 | 510128 | 5,29 | - | - |
| | 30x2 | 510136 | 6,08 | - | - |
| | 40x2 | 510095 | 8,58 | 510096 | 12,85 |
| | 50x2 | 510099 | 10,84 | 510097 | 16,25 |
| corner  | 10x10x1 | 510144 | 3,43 | - | - |
| | 15x15x1 | 510152 | 3,86 | - | - |
| | 20x20x1 | 510160 | 4,73 | 510158 | 7,08 |
| | 25x25x1 | 510168 | 5,29 | 510166 | 7,93 |
| | 30x30x1 | 510176 | 5,82 | 510174 | 8,73 |
| | 30x30x1,5 | 509020 | 8,25 | - | - |
| | 40x40x1,5 | 510384 | 10,78 | - | - |
| | 40x40x2 | 510381 | 16,13 | 510383 | 24,18 |
| corner L  | 15x10x1 | 510184 | 3,49 | | |
| | 20x10x1 | 510192 | 3,73 | | |
| | 30x15x1 | 510200 | 4,83 | | |
| U profile  | 8x8x1 | 510208 | 3,17 | | |
| | 10x10x1 | 510216 | 3,73 | | |
| | 10x15x1 | 510224 | 4,62 | | |
| | 12x12x1 | 510218 | 4,62 | | |
| double U profile  | 16x7x1 | 510232 | 4,21 | | |
| | 16x12x1 | 510240 | 5,41 | | |
| | 20x10x1 | 510248 | 5,41 | | |
| | 20x18x1 | 510256 | 7,11 | | |
| edge trim  | 18x1 | 510264 | 3,87 | | |
| | 22x1 | 510272 | 4,12 | | |
| | 25x1 | 510280 | 4,21 | | |
| round tube  | 8x1 | 509036 | 3,56 | | |
| | 10x1 | 509044 | 3,98 | | |
| | 12x1 | 509052 | 4,43 | | |
| | 15x1 | 510288 | 4,83 | | |
| | 18x1 | 510296 | 5,50 | | |
| | 20x1 | 510304 | 6,13 | | |
| square tube  | 25x1,5 | 509060 | 10,11 | | |
| | 10x10x1 | 510312 | 4,73 | | |
| | 15x15x1 | 510320 | 6,27 | | |
| rectangular tube  | 20x20x1 | 510328 | 7,86 | | |
| | 20x10x1 | 510336 | 6,27 | | |
| T profile  | 30x15x1 | 510344 | 8,03 | | |
| | 15x15x1,5 | 510352 | 4,92 | | |
| round bar  | 25x25x1,5 | 510360 | 7,10 | | |
| | Ø 6 | 509084 | 4,21 | | |
| | Ø 8 | 510368 | 5,71 | | |
| square bar  | Ø 10 | 509092 | 8,05 | | |
| | 8x8 | 510376 | 6,88 | | |
| | 10x10 | 510394 | 10,01 | | |

Articles no partial packaging. Pack. 10 pcs per item - Minimum order : 100 assorted pcs DIY range.







EAN 13 = the first group product code

example code 10395 = 8010937 10395

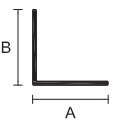
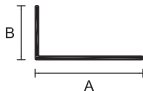
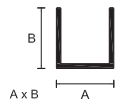
For a single piece, see sales conditions on page 288

profiles in anodised and colour-coated aluminium

with barcode label
length m. 2

| | measures | gold anodised | titanium anodised | colour-coated white RAL 9003 | euro/pc |
|---|-----------|---------------|-------------------|------------------------------|---------|
| piatto  | 12x2 | 10105 | - | - | 3,78 |
| | 15x2 | 10113 | - | 11612 | 4,47 |
| | 20x2 | 10121 | 10470 | 11620 | 4,99 |
| | 30x2 | 10137 | - | 11636 | 6,45 |
| angolare  | 10x10x1 | 10145 | 10452 | 11644 | 3,78 |
| | 15x15x1 | 10153 | 10454 | 11652 | 4,21 |
| | 20x20x1 | 10161 | 10456 | 11660 | 5,09 |
| | 25x25x1 | 10169 | 10458 | 11668 | 5,66 |
| | 30x30x1 | 10177 | - | 11676 | 6,18 |
| | 40x40x1,5 | 10385 | - | 11684 | 11,22 |
| angolare L  | 15x10x1 | 10185 | 10462 | 11692 | 3,86 |
| | 20x10x1 | 10193 | 10464 | 11700 | 4,10 |
| | 30x15x1 | 10201 | 10466 | 11708 | 5,22 |
| canalino a U  | 8x8x1 | 10209 | - | - | 3,52 |
| | 10x10x1 | - | - | 11724 | 4,10 |
| | 10x15x1 | 10225 | - | - | 4,99 |
| canalino a doppia U  | 20x18x1 | - | - | 11764 | 7,50 |
| unghietta  | 18x1 | 10265 | - | 11772 | 4,22 |
| | 22x1 | 10273 | - | - | 4,47 |
| | 25x1 | 10281 | - | - | 4,59 |
| tubo rotondo  | 10x1 | 09045 | - | - | 4,33 |
| | 15x1 | - | - | 11796 | 5,22 |
| | 18x1 | 10297 | - | - | 5,90 |
| | 20x1 | 10305 | - | - | 6,52 |
| tubo quadro  | 10x10x1 | - | - | 11820 | 5,09 |
| tubo rettangolare  | 20x10x1 | 10337 | - | 11844 | 6,66 |
| profilo a T  | 15x15x1,5 | - | - | 11860 | 5,30 |
| | 25x25x1,5 | - | - | 11868 | 7,49 |

Articles no partial packaging. Pack. 10 pcs for gold items, 5 pcs for titanium items



Minimum order: 100 assorted pcs DIY range.

EAN 13 = the first group product code

example code 10395 = 8010937 10395

For a single piece, see sales conditions on page 288

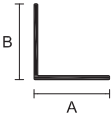
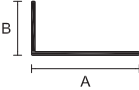
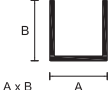
profiles in bright polished silver aluminium

| | | with barcode label | | | | |
|-----------|---|--------------------|---------|-------------|---------|------|
| | | length m. 1 | | length m. 2 | | |
| | | silver | euro/pc | silver | euro/pc | |
| flat |  | measures | | | | |
| | | 15x2 | - | - | 10115 | 6,97 |
| | | 20x2 | - | - | 10123 | 7,64 |
| | | 25x2 | - | - | 10131 | 8,56 |
| corner |  | 10x10x1 | 10143 | 3,26 | 10147 | 6,18 |
| | | 15x15x1 | 10151 | 3,51 | 10155 | 6,66 |
| | | 20x20x1 | 10159 | 4,08 | 10163 | 7,80 |
| | | 25x25x1 | - | - | 10171 | 8,64 |
| | | 30x30x1 | - | - | 10179 | 9,51 |
| corner L |  | 15x10x1 | - | - | 10186 | 6,33 |
| | | 20x10x1 | - | - | 10195 | 6,66 |
| | | 30x15x1 | - | - | 10203 | 8,13 |
| U profile |  | 10x10x1 | - | - | 10219 | 6,39 |
| | | 10x15x1 | - | - | 10227 | 7,75 |
| | | 12x12x1 | - | - | 10211 | 8,00 |
| edge trim |  | 18x1 | - | - | 10267 | 6,76 |
| T profile |  | 15x15x1,5 | 10351 | 4,28 | 10355 | 8,24 |

Pack. 5 pcs per article

Minimum order: 100 assorted pcs DIY range.

For a single piece, see sales conditions on page 288

polished brass and stainless steel corners

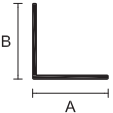
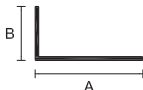
| | | with barcode label | | | |
|--|----------|--------------------|---------|-----------------|---------|
| | | length m. 2 | | | |
| corner | measures | polished brass | euro/pc | stainless steel | euro/pc |
|  | 15x15x1 | 10002 | 30,84 | 10050 | 12,17 |
| | 20x20x1 | 10006 | 39,35 | 10054 | 15,32 |
| | 25x25x1 | - | - | 10058 | 18,59 |
| | 30x30x1 | 10014 | 60,36 | 10062 | 22,58 |
| | 40x40x1 | - | - | 10070 | 29,32 |
|  | 15x10x1 | 10030 | 25,90 | - | - |
| | 20x10x1 | 10034 | 30,84 | 10082 | 12,17 |
| | 30x10x1 | - | - | 10086 | 15,33 |

Articles no partial packaging.

Pack. 5 pcs per article - Minimum order: 100 assorted pcs DIY range.

EAN 13 = the first group product code

example code 10094 = 8010937 10094

curtain counterweights in silver anodised aluminium with rounded edges

| | | length m. 1 | | length m. 2 | | length m. 4 | |
|---|----------------------|-------------|---------|-------------|---------|-------------|---------|
| | measures | cod. | euro/pc | cod. | euro/pc | cod. | euro/pc |
|  | 30x4 boxes pcs 10 | 10604 | 6,38 | 10605 | 12,75 | 10606 | 25,25 |
| | 40x4 boxes pcs 10 | 10608 | 8,63 | 10609 | 17,22 | - | - |

Articles no partial packaging.

EAN 13 = the first group product code

example code 10824 = 8010937 10824

For a single piece, see sales conditions on page 288

silver anodised aluminium profiles for structures

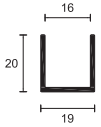
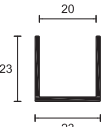
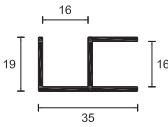
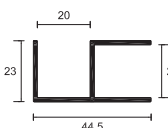
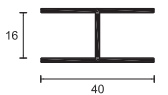
| | | | | with barcode label | | | | |
|------------------|---|---|----|--------------------|---------|-------------|---------|-------|
| | | | | length m. 2 | | length m. 3 | | |
| | | measures thickness | | cod. | euro/pc | cod. | euro/pc | |
| U profile |  | for panels frame thickness up to 16 mm Packaging 6 pcs per item. | 16 | 1,5 | 10500 | 11,70 | 10504 | 17,39 |
| U profile |  | for panels frame thickness up to 20 mm Packaging 6 pcs per item. | 20 | 1,5 | 10532 | 13,92 | 10536 | 20,71 |
| double U profile |  | for 90° corners between panel boards thickness up to 16 mm Packaging 6 pcs per item. | 16 | 1,5 | - | - | 10512 | 25,82 |
| double U profile |  | for 90° corners between panel boards thickness up to 20 mm Packaging 6 pcs per item. | 20 | 1,5 | - | - | 10544 | 31,23 |
| H profile |  | for connection of panels thickness up to 16 mm Packaging 6 pcs per item. | 16 | 1,5 | - | - | 10520 | 28,34 |



Design is our best profile.

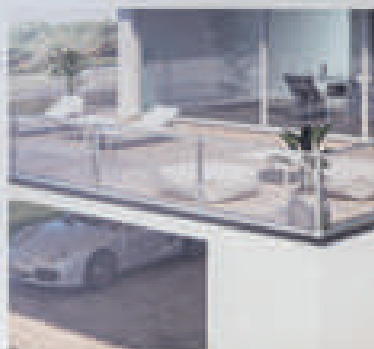

Design is our best profile.





merchandising for the point of sale

A series of tools dedicated to the showroom: modular expositive pieces of furniture, counter display boxes, sampleboards, sample boxes, cylinders etc for creating suitable areas for every need of space and products.



Profilpas concept store: a modular display system composed of panels that can be used singularly or combined together. For each panel, there is the possibility to choose the display units according to the products treated.

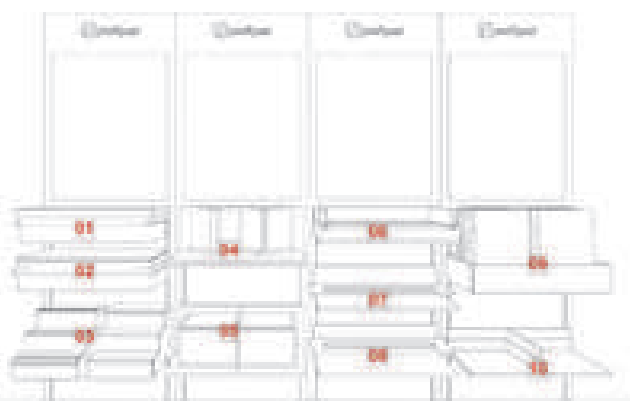

| | | |
|---|-------|----------|
| PANEL 1 terrace picture DIM. CM 90X220 H. | 02036 | € 219,90 |
| PANEL 2 living room picture DIM. CM 90X220 H. | 02037 | € 219,90 |
| PANEL 3 bathroom picture DIM. CM 90X220 H. | 02038 | € 219,90 |
| PANEL 4 staircase picture DIM. CM 90X220 H. | 02039 | € 219,90 |

| | | |
|---------------------------------|-------|----------|
| SELF-SUPPORTING BASE FOR PANELS | 02040 | € 142,29 |
|---------------------------------|-------|----------|

| | | |
|---|-------|----------|
| DISPLAY UNIT 1 - CPGV+CPQV+WPSTOP 3 | 02041 | € 129,35 |
| DISPLAY UNIT 2 - CPNV+CPCV/30 | 02042 | € 90,55 |
| DISPLAY UNIT 3 - SNG+SIR+SIG+SIS+SP+76 | 02043 | € 219,90 |
| DISPLAY UNIT 4 - GIN+ILN+ZQIN | 02044 | € 271,64 |
| DISPLAY UNIT 5 - ZQVN Trend Color Stone | 02045 | € 271,64 |
| DISPLAY UNIT 6 - SLIM DRAIN+GLASS PROFILE | 02046 | € 620,27 |
| DISPLAY UNIT 7 - SMART DRAIN | 02047 | € 530,33 |
| DISPLAY UNIT 8 - THIN DRAIN | 02048 | € 478,60 |
| DISPLAY UNIT 9 - case for sample boards (without sample boards) | 02049 | € 84,08 |
| DISPLAY UNIT 10 - 8605+8608 | 02055 | € 64,68 |
| DISPLAY UNIT 11 - PP LEVEL DUO | 02064 | € 152,46 |
| DISPLAY UNIT 7/a - shelf only | 02056 | € 45,27 |



self-supporting base for panels



display unit 1
CPGV - WPstop 3



display unit 7
Smart Drain



display unit 2
CPNV - CPCV/30



display unit 8
Thin Drain

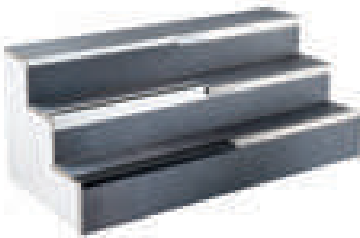

display unit 3
SNG + SIR + SGI + SIS +
SP - 76



display unit 9
case for sample boards



display unit 4
GIN + ILN + ZQIN



display unit 10
8605 - 8608

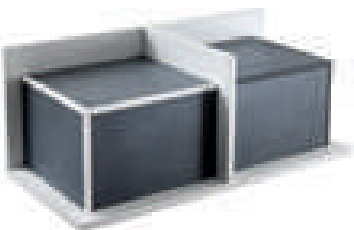

display unit 5
ZQVN Trend Color Stone



display unit 11
PP Level Duo®



display unit 6
Slim Drain + Glass Profile



display unit 7/A
shelf only



| | | |
|--|-------|----------|
| black totem for sample boards dim. cm 55x55x200 h | 02034 | € 316,65 |
| white totem for sample boards dim. cm 55x55x200 h. | 02035 | € 316,65 |



Exhibition panels divided for different application categories. They are also suitable for inclusion in the drawer corner shop.

| | | | |
|-----------------------------|---|-------|---------|
| sampleboard 1 | PROLIST decorative listellos and profiles | 02015 | € 35,26 |
| sampleboard 2 | external corners profiles PROTRIM | 02016 | € 35,26 |
| sampleboard 3 | external corners profiles PROANGLE Q | 02017 | € 35,26 |
| sampleboard 4 | external corners profiles PROCORNER internal corners profiles PROROUND | 02018 | € 35,26 |
| sampleboard 5 | profiles for small gaps | 02019 | € 35,26 |
| sampleboard 6 | profiles for floors of same height | 02020 | € 35,26 |
| sampleboard 7 | profiles for floors of different height | 02021 | € 35,26 |
| sampleboard 8 | profiles for LVT floors | 02022 | € 35,26 |
| sampleboard 9 | Expansion joints PROJOINT | 02023 | € 35,26 |
| sampleboard 10 | profiles for balconies and terraces PROTEC | 02024 | € 35,26 |
| sampleboard 11 | stair nosing profiles | 02025 | € 35,26 |
| NEW sampleboard 12/A | Unisystem plus | 02065 | € 35,26 |
| NEW sampleboard 12/B | prestowood - pvc line | 02066 | € 35,26 |
| sampleboard 13/A | METAL LINE 89-90-790 | 02057 | € 35,26 |
| sampleboard 13/B | METAL LINE 87-88-92-93-95-97-98-100 | 02058 | € 35,26 |
| NEW sampleboard 14 | Trend Color | 02028 | € 35,26 |
| NEW sampleboard 17 | PVC Line skirting boards | 02078 | € 35,26 |



| | | |
|---|-------|---------|
| NEW black counter display Trend Color Proangle Q | 00193 | € 64,00 |
| NEW black counter display Trend Color Proangle | 00219 | € 64,00 |
| black counter display Proangle Q | 00166 | € 34,97 |

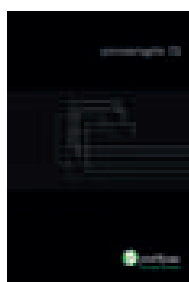





| | | |
|-------------------------------|-------|------------|
| sample box PROANGLE Q ITA/GB | 00184 | €/pz 20,19 |
| sample box PROANGLE Q FR/TED | 00188 | €/pz 20,19 |
| sample box PROANGLE Q SPA/POR | 00189 | €/pz 20,19 |



| | | |
|------------------------------|-------|---------|
| cylinder wall profiles | 00103 | € 15,67 |
| cylinder floor profiles | 00104 | € 15,67 |
| cylinder small gaps profiles | 00114 | € 15,67 |
| cylinder proangle Q | 00115 | € 15,67 |
| cylinder unisystem | 00080 | € 15,67 |
| cylinder proline | 00127 | € 15,67 |
| cylinder LVT | 00142 | € 15,67 |
| cylinder proligh | 00143 | € 15,67 |



| | | | |
|---|-----------------|-------|---------|
|  | sample DJKC/10 | 00134 | € 13,43 |
|  | sample DJKC/10 | 00135 | € 21,67 |
|  | sample UKC/10 | 00136 | € 25,90 |
|  | sample DJKGC/10 | 00137 | € 41,31 |
|  | sample UKGC/10 | 00138 | € 46,06 |



| | | |
|--|-------|--------|
| NEW brochure profiles and skirting boards for wood and laminate IT/GB | 00285 | € 1,20 |
| brochure profiles and skirting boards for wood and laminate FR/DE | 00286 | € 1,20 |
| brochure profiles and skirting boards for wood and laminate ES/PT | 00287 | € 1,20 |
| brochure profiles and skirting boards for wood and laminate CZ/PL | 00290 | € 1,20 |



| | | |
|---|-------|--------|
| NEW brochure profiles for balconies and terraces IT/GB | 00279 | € 1,20 |
| brochure profiles for balconies and terraces FR/DE | 00280 | € 1,20 |
| brochure profiles for balconies and terraces ES/PT | 00281 | € 1,20 |
| brochure profiles for balconies and terraces CZ/PL | 00288 | € 1,20 |



| | | |
|---|-------|---------|
| profiles for balconies and terraces bunch | 00117 | € 19,74 |
|---|-------|---------|

| | | |
|---|-------|---------|
| sampleboard 10 profiles for balconies and terraces PROTEC | 02024 | € 35,26 |
|---|-------|---------|



| | | |
|-----------------------------------|-------|----------|
| display unit 1 CPGV+CPQV+WPSTOP 3 | 02041 | € 129,35 |
| display unit 2 CPNV - CPCV/30 | 02042 | € 90,55 |



| | | | |
|------------|--|-------|----------|
| NEW | counter display pp drain aqua - classic cover dim. cm 70x32x30 H. (cover not included, to be ordered separately) | 02072 | € 231,00 |
| | counter display pp drain aqua - flat cover dim. cm 70x32x30 H. (cover not included, to be ordered separately) | 02073 | € 231,00 |
| | counter display pp drain aqua - design cover dim. cm 70x32x30 H. (cover not included, to be ordered separately) | 02074 | € 231,00 |

| | | | |
|------------|---|-------|---------|
| NEW | counter display pp drain aqua - classic cover dim. cm 70x32x30 H. (linear drain and cover not included, to be ordered separately) | 02075 | € 63,00 |
| | counter display pp drain aqua - flat cover dim. cm 70x32x30 H. (linear drain and cover not included, to be ordered separately) | 02076 | € 63,00 |
| | counter display pp drain aqua - design cover dim. cm 70x32x30 H. (linear drain and cover not included, to be ordered separately) | 02077 | € 63,00 |



| | | | |
|------------|------------------------------------|-------|---------|
| NEW | pp drain aqua finishes sampleboard | 00164 | € 46,20 |
|------------|------------------------------------|-------|---------|

| | | | |
|------------|------------------------------|-------|--------|
| NEW | brochure pp drain aqua IT/GB | 00295 | € 1,27 |
| | brochure pp drain aqua FR/DE | 00296 | € 1,27 |
| | brochure pp drain aqua ES/PT | 00297 | € 1,27 |
| | brochure pp drain aqua CZ/PL | 00298 | € 1,27 |



| | | | |
|------------|---|-------|--------|
| NEW | catalogue/price list linear shower drains and systems for bathrooms 2022 IT | 00360 | € 1,40 |
| | catalogue/price list linear shower drains and systems for bathrooms 2022 GB | 00361 | € 1,40 |
| | catalogue/price list linear shower drains and systems for bathrooms 2022 FR | 00362 | € 1,40 |
| | catalogue/price list linear shower drains and systems for bathrooms 2022 DE | 00363 | € 1,40 |
| | catalogue/price list linear shower drains and systems for bathrooms 2022 ES | 00364 | € 1,40 |
| | catalogue/price list linear shower drains and systems for bathrooms 2022 PT | 00365 | € 1,40 |
| | catalogue/price list linear shower drains and systems for bathrooms 2022 CZ | 00366 | € 1,40 |
| | catalogue/price list linear shower drains and systems for bathrooms 2022 PL | 00367 | € 1,40 |
| | catalogue/price list linear shower drains and systems for bathrooms 2022 RU | 00368 | € 1,40 |



| | | | |
|------------|---|-------|--------|
| NEW | sample of glass profile in satin stainless steel | 00072 | € 1,91 |
| | sample of glass profile in matt black colour-coated stainless steel | 00078 | € 2,92 |



| | | | |
|------------|--|-------|---------|
| NEW | counter display glass profile - satin stainless steel | 00311 | € 63,00 |
| | counter display glass profile - matt black colour-coated stainless steel | 00315 | € 63,00 |



| | | | |
|-----------------------|-------|------|-------|
| leaflet WPSTOP IT/GB | 00176 | €/pz | 0,21 |
| sample box WPSTOP ITA | 00182 | €/pz | 10,70 |
| sample box WPSTOP GB | 00183 | €/pz | 10,70 |
| sample box WPSTOP TED | 00185 | €/pz | 10,70 |
| sample box WPSTOP SPA | 00186 | €/pz | 10,70 |
| sample box WPSTOP POR | 00187 | €/pz | 10,70 |

| | | | |
|-------------------------|-------|---|------|
| sample box PP Level DUO | 00038 | € | 9,15 |
|-------------------------|-------|---|------|

| | | | |
|---|-------|------|-------|
| NEW sample of PP Level DUO double joist system | 00047 | €/pz | 15,50 |
|---|-------|------|-------|

| | | | |
|-----------------------------|-------|---|------|
| brochure PP Level DUO IT/GB | 00042 | € | 1,27 |
| brochure PP Level DUO FR/DE | 00043 | € | 1,27 |
| brochure PP Level DUO ES/PT | 00044 | € | 1,27 |
| brochure PP Level DUO PL/CZ | 00045 | € | 1,27 |
| brochure PP Level DUO RU/HR | 00046 | € | 1,27 |

| | | | |
|----------------------------|-------|---|------|
| leaflet PP Level DUO IT/GB | 00260 | € | 0,21 |
| leaflet PP Level DUO FR/DE | 00261 | € | 0,21 |
| leaflet PP Level DUO ES/PT | 00262 | € | 0,21 |
| leaflet PP Level DUO PL/CZ | 00263 | € | 0,21 |
| leaflet PP Level DUO RU/HR | 00264 | € | 0,21 |

| | | | |
|--|-------|---|------|
| NEW PROTILER - sample kit 20 PTWN + 20 PTC2 | 00207 | € | 1,80 |
| KLIC LEVEL - sample kit 4 pcs. | 00105 | € | 1,86 |
| FIX LEVEL - sample kit 4 pcs. | 00089 | € | 1,86 |
| FIVE - sample kit 4 pcs. | 00083 | € | 1,86 |

| | | | |
|--|-------|---|-------|
| NEW Prottiler floor-standing display ESPT | 11595 | € | 68,64 |
|--|-------|---|-------|

| | | | |
|-------------------------------------|-------|---|------|
| NEW brochure Prottiler IT/GB | 00291 | € | 0,30 |
| brochure Prottiler FR/DE | 00292 | € | 0,30 |
| brochure Prottiler ES/PT | 00293 | € | 0,30 |
| brochure Prottiler CZ/PL | 00294 | € | 0,30 |



PDS bunch

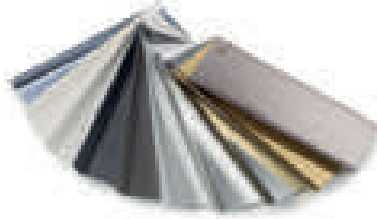

metal line bunch



bunch 8605/8608



pvc skirting board bunch



bunch ZQP



bunch RPA



profiles for balconies bunch



bunch RE



bunch REC



bunch RECO



DIY bunch



sandblast stainless steel bunch



chromium-plated brass bunch



antibacterial profiles bunch

| | | |
|--|-------|---------|
| PDS bunch | 00020 | € 9,91 |
| 8605/8608 bunch | 00126 | € 3,55 |
| metal line bunch | 00119 | € 16,94 |
| PVC skirting board bunch | 00085 | € 6,36 |
| profiles for balconies bunch | 00117 | € 19,74 |
| ZQP bunch | 00027 | € 6,36 |
| RPA bunch | 00050 | € 6,36 |
| RE bunch | 00011 | € 6,36 |
| REC bunch | 00049 | € 6,36 |
| RECO bunch | 00133 | € 6,36 |
| DIY bunch | 00128 | € 12,71 |
| chromium-plated brass bunch | 00130 | € 15,52 |
| sandblast stainless steel profiles bunch | 00132 | € 3,55 |
| bunch pvc stair nosing | 00084 | € 6,36 |
| bunch antibacterial profiles | 00147 | € 3,55 |
| bunch PDS xl | 00140 | € 40,30 |
| bunch black & white | 00033 | € 6,72 |
| NEW bunch ZQVN Trend Color | 00021 | € 18,20 |
| NEW bunch ZV Trend Color | 00023 | € 18,20 |
| bunch IPV Trend Color Stone | 00037 | € 12,71 |
| NEW bunch Prestowood | 00039 | € 12,71 |

MATERIALS AND CHARACTERISTICS

The following information summarize the main characteristics of the materials. Further information are available upon request of the product specifications.

NATURAL BRASS

Alloy CW624N UNI EN 12167 The profiles are produced by extrusion. They have a good resistance to chemical agents and mechanical stresses. On the visible parts the brass naturally oxidizes that creates a superficial glaze. The brass, when exposed to corrosive agents or high humidity, is subject to phenomena of high oxidation and can present superficial spots. Where necessary, it can be restored to its original state by using abrasives or specific polishing products.

POLISHED BRASS

Alloy CW624N UNI EN 12167 The profiles are produced by extrusion and then mechanically polished. The visible surface must be protected from scratches and frictions. The resistance to chemical agents and mechanical stresses is good. On the visible parts the brass naturally oxidizes that creates a superficial glaze. The brass, when exposed to corrosive agents or high humidity, is subject to phenomena of high oxidation and can present superficial spots. Where necessary, it can be restored to its original state by using abrasives or specific polishing products.

CHROMIUM - PLATED BRASS

Alloy CW624N UNI EN 12167 The profiles are produced by extrusion and then chromed. They are resistant to ultraviolet rays, weathering and chemical agents. They are not suitable for applications in floors with intense mechanical stresses.

NATURAL ALUMINIUM

Alloy of Al-Mg-Si thermally treated in conditions T6 (6060 T6) The profiles are produced by extrusion and guarantee a fair resistance to atmospheric and chemical agents. The cement and its derivatives produce, if wet, alkaline substances that, acting on the surface, can corrode the metal (formation of hydroxide of aluminium). For that reason, the visible surface of the profile must be immediately cleaned from cement, glue and other materials used for joints.

ANODISED ALUMINIUM

Alloy of Al-Mg-Si thermally treated in conditions T6 (6060 T6) The profiles are produced by extrusion and then anodised. They have a good resistance to atmospheric and chemical agents. The cement and its derivatives produce, if wet, alkaline substances that, acting on the surface, can corrode the metal (formation of hydroxide of aluminium). For that reason, the visible surface of the profile must be immediately and gently cleaned from cement, glue and other materials used for joints. Wear and pedestrian traffic could damage the surface (in cases of profiles laid on the floor) and remove the original anodised finish.

POLISHED ALUMINIUM

Alloy of Al-Mg-Si thermally treated in conditions T6 (6060 T6) The profiles are produced by extrusion and then mechanically treated and processed. They guarantee a fair resistance to atmospheric and chemical agents. The cement and its derivatives produce, if wet, alkaline substances that, acting on the surface, can corrode the metal (formation of hydroxide of aluminium). For that reason, the visible surface of the profile must be immediately and gently cleaned from cement, glue and other materials used for joints. Polished aluminium profiles are not suitable for floor applications.

COLOUR - COATED ALUMINIUM

Alloy of Al-Mg-Si thermally treated in conditions T6 (6060 T6) The profiles are made by extrusion and then coated with a thickness of $\geq 80 \mu\text{m}$. They have

a fair resistance to atmospheric and chemical agents while they do not have a good resistance to mechanical stresses that would damage the surface enamel; therefore they are not recommended for floor applications. For that reason, the visible surface of the profile must be immediately and gently cleaned from cement, glue and other materials used for joints.

ALCROM® PLUS FOILED ALUMINIUM

Alloy of Al-Mg-Si thermally treated in conditions T6 (6060 T6) The profiles are produced by extrusion in natural alloy. The wood decoration is obtained by foiling the aluminium profiles with a special film Alcrom® Plus, resistant to wear, perfectly reproducing grains and colours of wood.

STAINLESS STEEL - AISI 430 - DIN 1.4016

This kind of stainless steel has a moderate resistance to corrosive agents. We recommend its use exclusively for indoor use.

STAINLESS STEEL - AISI 304 - DIN 1.4301 V2A

It is extremely resistant to most chemical and atmospheric agents, lime, mortar, tile glue and common cleaning products. It is recommended for outdoor use, food processing industry, hospitals, etc.

STAINLESS STEEL - AISI 316 – DIN 1.4404 V4A

It is extremely resistant to most chemical and atmospheric agents, lime, mortar, tile glue and common cleaning products. Moreover it has a good resistance to chlorine and salt. Particularly indicated in extreme conditions of use.

LAYING - WARNINGS:

even stainless steel can be damaged if not treated with proper precautions during the laying stages. In particular, pay attention to: keeping the profiles protected inside their individual packaging up until the installation. (this precaution allows to avoid the contamination with other ferrous materials during the transport). Avoiding the direct contact with cleaning products for cotto tiles and marble, decalcifying agents and cleansers containing chlorine and its compounds. Pay attention to the gases of hydrochloric acid which may develop during the cleansing of special floors. After the laying, proceed immediately with an accurate cleaning of the surface with plenty of water and the consequent drying.

MAINTENANCE:

the frequent cleaning is essential to preserve the beauty of stainless steel profiles surfaces. Pay close attention to the treatment of the profiles' surface during the installation. Immediately after installation, clean by rinsing the surfaces accurately. Avoid the use of abrasive products that may scratch the profile. Do not use cleansers containing chlorine and its compounds, such as bleach, muriatic acid, decalcifying agents. Do not use abrasive sponges or wire wools that may scratch the surface or leave rust stains.

CHROMIUM-PLATED STAINLESS STEEL - AISI 304 - DIN 1.4301 (profilpas design)

It has a refined aesthetic value. It is suitable for wall coverings but not for floors: the cleaning maintenance should be done with sponges or soft and non-abrasive cloths. We suggest to use neutral detergents.

Rigid PVC

Vinyl compound of rigid PVC unleaded, anti shock, non-flammable. Mixture eco-friendly with Ca-Zn salts.

Plasticized PVC

Vinyl compound of plasticized PVC unleaded, non-flammable. Mixture eco-friendly with Ca-Zn salts.

Foam PVC

Vinyl compound of plasticized PVC unleaded, non-flammable. Mixture eco-friendly with Ca-Zn salts.

Co-extruded PVC - Rigid/Rigid

Vinyl compound of rigid PVC unleaded, anti-shock non-flammable. Mixture eco-friendly with Ca-Zn salts.

Co-extruded PVC - Plasticized/Plasticized

Vinyl compound of plasticized PVC unleaded, non-flammable. Mixture eco-friendly with Ca-Zn salts.

Co-extruded PVC - Rigid/Plasticized

Vinyl compound of rigid PVC unleaded, anti-shock, non-flammable. Mixture eco-friendly with Ca-Zn salts. Vinyl compound of plasticized PVC unleaded, non-flammable. Mixture eco-friendly with Ca-Zn salts.

Co-extruded PVC - Rigid/Plasticized anti-mould

Vinyl compound of rigid PVC unleaded, anti-shock, non-flammable. Mixture eco-friendly with Ca-Zn salts. Vinyl compound of plasticized PVC unleaded, non-flammable, addicted with biocide. Mixture eco-friendly with Ca-Zn salts.

Co-extruded PVC - Foam/Plasticized

Vinyl compound of foam PVC unleaded, non-flammable. Mixture eco-friendly with Ca-Zn salts. Vinyl compound of plasticized PVC unleaded, non-flammable. Mixture eco-friendly with Ca-Zn salts.

ADVICES FOR CLEANING AND MAINTENANCE

| MATERIAL | FINISHING | CLEANING AFTER LAYING | MAINTENANCE |
|-----------------|--------------------------|---|--|
| aluminium | anodised | Use of acid based cleaners and not alkaline | exclusive use of neutral cleaning products |
| aluminium | bril. polished | Use of acid based cleaners and not alkaline | exclusive use of neutral cleaning products |
| aluminium | bright polished copper | Use of acid based cleaners and not alkaline | exclusive use of neutral cleaning products |
| aluminium | bright polished titanium | Use of acid based cleaners and not alkaline | exclusive use of neutral cleaning products |
| aluminium | bright polished gold | Use of acid based cleaners and not alkaline | Exclusive use of neutral cleaning products |
| aluminium | color-coated | Use of acid based cleaners | use neutral or alkaline detergents |
| aluminium | bright satin | Use of acid based cleaners and not alkaline | exclusive use of neutral cleaning products |
| aluminium | riv. Alcrom Plus | Use of acid based cleaners | Exclusive use of neutral cleaning products |
| stainless steel | polished | Use of acid based cleaners without chlorine | use neutral or alkaline detergents |
| stainless steel | Inox AISI 316 | Use of acid based cleaners | exclusive use of neutral cleaning products |
| stainless steel | sandblast | Use of acid based cleaners only neutral | use neutral or alkaline detergents |
| stainless steel | satin | Use of acid based cleaners without chlorine | use neutral or alkaline detergents |
| brass | natural | Use of acid based cleaners only neutral | exclusive use of neutral cleaning products |
| brass | polished | Use of acid based cleaners only neutral | exclusive use of neutral cleaning products |
| brass | chromium - plated | Use of acid based cleaners | use neutral or alkaline detergents |
| PVC | | Use of acid based cleaners and not alkaline | exclusive use of neutral cleaning products |

PROFILES CHARACTERISTICS AND PACKAGING

SELF-ADHESIVE PROFILES

Self-adhesive profiles are made of non-toxic, non-flammable and solvent free hot-melt glues. Although these products are non-flammable, it is recommended not to expose them to naked flames. Product preservation is guaranteed when stored in "normal" climatic conditions.

Glue deteriorates at temperatures over +90°C and crystallizes at temperatures below -15°C. During the application, the temperature of self-adhesive profiles and the ambient temperature where profiles have to be laid should not be below +10°C.

Important: self-adhesive profiles cannot be laid on friable supports, as junction between two carpet floors or between PVC floors and wall coverings.

DRILLED PROFILES

Screw-mounted profiles are drilled according to the model and the material at issue, so that to lodge 3 mm or 3,5 mm screws, either flat-head or round-head ones.

PACKAGING

The  means blister packaging.

"Individually packed" means that the packaging is made for the single profile with a protective heat shrink film.

MEASURES - TOLERANCES - REFERENCES NORMS - CERTIFICATION ON PRODUCT

Please note that the information and the drawings in the present catalogue are not binding.

The data about measures, such as length, thickness and width refer to nominal measures. The foreseen tolerances, the related norms and reference certifications are indicated in the specifications of products, available on request.

DIRECTIONS

The resistance to chemical products depends on their degree of chemical aggressiveness and therefore it is necessary to make sure in advance of the effects that products used for profile laying, cleaning and maintenance can produce. In particular lime, mortar or tile glue cause strains on the visible surface of profiles. Therefore it is necessary to clean these parts immediately after the laying of the profiles. Please note that in the present catalogue, due to the printing, the colour shades can be slightly different from the real ones.

GENERAL CONDITIONS OF SALE

These General Conditions shall govern all sales contracts executed between Profilpas S.p.A. and the Buyer and shall prevail on all the Buyer's general or individual purchasing conditions. Any derogation to these General Conditions shall be binding on Profilpas only if accepted in writing by the latter.

1. Prices

The prices shown in Profilpas' price list are in Euro per meter but products will be invoiced in Euro per piece with the discounts granted in accordance with the ordered quantities or upon agreement with Profilpas. Prices are exclusive of additional taxes or customs duties. Profilpas expressly reserves the right to modify the prices without notice, in accordance with any fluctuation in the costs of raw materials.

2. Minimum orders

The required minimum order value is fixed at the amount of Euro 500,00.

3. Orders

Purchase orders must be sent in writing. Orders shall be deemed accepted and binding on Profilpas only after receipt by the Buyer of Profilpas' written order confirmation. Only the discounts and the prices indicated in the order confirmation shall be binding for Profilpas. Should the order confirmation contain amendments with respect to the Order, such amendments shall be deemed tacitly accepted by the Buyer after 5 (five) days from receipt of the order confirmation unless the Buyer notifies its disagreement in writing within the above-mentioned term.

4. Delivery terms

Deliveries shall be made EX WORKS (Incoterms 2010) Profilpas warehouse in Cadoneghe (Padova) - Italy. The products shall always be transported at the Buyer's risk according to the Incoterms, and any reimbursements for damages shall be claimed by the Buyer to the carrier in accordance with the relevant agreements and clauses contained in the stipulated insurance policies. Delivery dates are estimated and not guaranteed. Profilpas shall not be responsible for any delay nor for the consequences thereof. In case of delay in delivery, the Buyer shall not have the right to terminate the sales agreement and/or obtain compensation of any direct, indirect or consequential damage suffered, unless in case of intent or gross negligence.

5. Packaging

Prices include Profilpas standard packaging. Sea shipment packaging or any other special packaging requested by the Buyer will be charged at cost. Profilpas' catalogue indicates which products have partial packaging and the surcharge applied in such case. In case of products without partial packaging, Profilpas can exceptionally sell them with partial packaging, charging the price on the pricelist without discount.

6. Terms of payment

All payments must be made in accordance with the agreed terms of payment; the relevant sums must be transferred to the bank indicated by Profilpas. In case of delay of payment, whether total or partial, the Buyer shall be bound to pay interest on all outstanding amounts calculated according to art. 5 of Italian Legislative Decree no. 231/2002 or subsequent modifications.

Delay or non-payment of any sums due by the Buyer to Profilpas, even if concerning different contractual relationships, shall entitle Profilpas to suspend the preparation and delivery of the products which are the object of the order and of any other order in progress.

7. Claims

Claims must be notified in writing to Profilpas within 10 days from the delivery date. Claims for damaged, stolen or missing products shall be lodged with the carrier upon receipt of the products. If no written

complaint is lodged with the carrier, Profilpas will not accept any return or replacement of the delivered products. Return of products will only be accepted upon Profilpas' prior written consent and always at the Buyer's expense.

8. Retention of title (article 1523 of the Italian Civil Code)

The products shall remain the property of Profilpas until full payment. Non-compliance, or partial compliance, of the agreed payment terms allow Profilpas, without prejudice to any other claim it may have, to recover the products supplied, even if transferred to third parties. The Buyer is liable for any damage to the products due to poor storage or negligence and shall be responsible as a depositary. Profilpas does not assume responsibility for damage to the products consequential or subsequent to the installation of the same.

9. Warranty and defects

Profilpas guarantees that the products are free from defects in material and workmanship for a period of 12 months from the date of delivery to the Buyer. Should Profilpas acknowledge the existence of the claimed defects, and provided that it has been promptly notified in accordance with the above mentioned paragraph "Claims", Profilpas' warranty shall be limited, at its discretion, to the replacement of the defective products, free of charge EXW Profilpas' premises (Incoterms 2010), within the normal time required therefor, or to the issue of a credit note for the amount of the defective products, ANY OTHER LEGAL OR CONVENTIONAL WARRANTY OR CLAIMS FOR ANY FURTHER DIRECT, INDIRECT OR CONSEQUENTIAL DAMAGES SUSTAINED BY THE BUYER OR THIRD PARTIES, UNLESS IN CASE OF INTENT OR GROSS NEGLIGENCE, BEING EXPRESSLY EXCLUDED.

The Buyer expressly waives its right of regress according to article 131 of the Italian Consumers' Code.

No products will be returned by the Buyer without prior written permission by Profilpas. Profilpas does not guarantee the compliance of the products to any particular specifications or technical characteristics or their suitability for any use and/or special uses if not to the extent that such characteristics have been expressly agreed in the sales contract. Profilpas is not liable for damages that the Buyer, or third parties, generate by using the products if the damage does not depend on the quality or intrinsic characteristics of the product, but by the choice of purchase and usage of the same by the Buyer.

10. Industrial and intellectual property

Profilpas Spa's trademarks, distinguishing signs, designs, photographs of products and/or production and commercial technology shall be considered strictly confidential and shall not be used without prior written authorisation from the same.

11. Express delivery

Upon the Buyer's request, Profilpas can offer a service of express delivery. The surcharge for this express service will be communicated with the order confirmation.

12. Privacy

Personal and fiscal details which may be acquired directly by Profilpas spa (Via Einstein 38 – Cadoneghe), the data controller, or via third parties, shall be used for contractual purposes, pursuant to law, to manage business relations and promote sales. Said data may be communicated to third parties both in Italy and abroad such as Profilpas spa's network of sales representatives, financial institutions, factoring companies, insurance, debt recovery and business information companies as well as professionals, management consultants and carriers.

13. Final clauses

Profilpas sales are governed by the laws of Italy.

In case of dispute, the courts of Padua – Italy shall be the exclusive competent venue.

| | | | | | |
|-----------------|-----------------|-----------------|-----------|------------------|-----------|
| 020/ | 106 | 88/6E | 206 - 237 | 97/8I | 213 |
| 023/ | 109 | 89/ | 202 - 203 | 97/8P | 213 |
| 024/ | 109 | 89/ EI | 202 - 203 | 97/8SF | 213 |
| 026/ | 107 | 89/ TM | 202 | 98/7E | 210 |
| 030/ | 109 | 89/ TMEI | 202 | 98/7G | 210 |
| 040/ | 109 | 89/6L | 203 - 238 | 98/7I | 210 |
| 050/ | 133 | 89/6EI | 203 - 238 | 98/7P | 210 |
| 060/ | 133 | 89/6I3 | 204 | 98/7SF | 210 |
| 076/ | 44 | 89/6I3EI | 204 | 99/M | 104 |
| 080/ | 133 | 89H/ | 202 | 99/R/ | 104 |
| 0100/ | 133 | 89H/ EI | 202 | 99/T/ | 102 - 189 |
| 6/ | 119 | 90/ A | 198 | 99/TR/26 | 102 - 189 |
| 10/ | 119 | 90/ E | 199 | 100/ | 208 |
| 10/15 | 255 | 90/ G | 199 | 101/74 | 208 |
| 19/ | 108 | 90/ I | 199 | 105/7 | 205 |
| 21/ | 105 | 90/ MI | 199 | 105/7E | 205 |
| 22/A | 108 - 182 - 183 | 90/ ME | 199 | 105/7G | 205 |
| 25/ | 108 | 90/ MG | 199 | 105/7I | 205 |
| 25/37/4 | 249 | 90/ MP | 199 | 105/7P | 205 |
| 25/37/B | 251 - 253 | 90/ P | 199 | 105/CB | 205 |
| 30/ | 105 | 90/ SF | 198 | 110/ | 160 |
| 35/ | 105 | 90/ SSF | 198 | 111/ /F | 157 - 190 |
| 37/61/4 | 249 | 90/ TMSF | 198 | 124/ | 160 |
| 37/61/B | 251 - 253 | 90/ TSF | 198 | 125/ | 162 |
| 41/ | 105 | 90H/6ME | 198 | 126/ | 161 |
| 45/ | 114 | 90H/6MG | 198 | 126/L/F | 235 |
| 46/ | 119 | 90H/6MI | 198 | 126/LP/DX | 235 |
| 50/A | 182 - 183 | 90H/6MP | 198 | 126/LP/SX | 235 |
| 54/ | 119 | 90H/6SF | 198 | 130/ | 159 |
| 55/ | 116 | 92/7 | 201 | 148/B | 226 |
| 57/ | 116 | 93/ | 201 | 148/C | 226 |
| 58/ | 158 - 184 | 94/169/4 | 249 | 150 | 164 |
| 60/105/4 | 249 | 94/169/B | 251 - 253 | 150/ | 168 |
| 60/105/B | 251 - 253 | 95/ E | 209 | 150/280/4 | 249 |
| 61/ | 116 | 95/ G | 209 | 150/280/B | 251 - 253 |
| 63/A | 182 - 183 | 95/ I | 209 | 151 | 164 |
| 70/ | 159 | 95/ P | 209 | 151/11 | 168 |
| 71/ | 159 | 95/ SF | 209 | 152 | 164 |
| 72/ | 162 | 97/4E | 211 | 154 | 165 |
| 73/ | 158 - 184 | 97/4G | 211 | 155 | 165 |
| 74/ | 158 - 184 | 97/4I | 211 | 155/16 | 168 |
| 75/F | 157 - 190 | 97/4P | 211 | 156 | 165 |
| 76/ | 160 | 97/4SF | 211 | 161/11 | 169 |
| 78/ | 163 | 97/7E | 212 | 163/ | 168 |
| 79/ | 162 | 97/7G | 212 | 168/16 | 169 |
| 80/ | 161 | 97/7I | 212 | 169 | 227 |
| 87/ | 158 | 97/7P | 212 | 169/ | 169 |
| 87/6 | 206 - 237 | 97/7SF | 212 | 170 | 227 |
| 88/6 | 206 - 237 | 97/8CB | 213 | 170/ | 169 |
| 88/16SF | 206 | 97/8E | 213 | 171 | 227 |
| 88/16L/A | 206 - 237 | 97/8G | 213 | 171/11 | 169 |

| | | | | | |
|-----------|-----------------|-----------|-----|--------------|-----------------------|
| 172 | 226 | 740/ | 109 | 8582 | 222 |
| 173 | 226 | 750/ | 133 | 8596 | 222 |
| 174/ | 169 | 760/ | 133 | 8598 | 222 |
| 175/11 | 169 | 774/ | 43 | 8600 | 221 |
| 177/16 | 169 | 775/ | 43 | 8602 | 223 |
| 178/16 | 169 | 776/ | 43 | 8602/C | 211 - 223 - 224 - 225 |
| 210/ | 42 | 777/ | 43 | 8602/E | 223 |
| 210H/A | 42 | 779/SF | 43 | 8602/I | 223 |
| 220/ | 42 | 780/ | 133 | 8602/P dx/sx | 223 |
| 239/320/4 | 249 | 790/ ME | 200 | 8603 | 224 |
| 239/320/B | 251 - 253 | 790/ MES | 200 | 8603/E | 224 |
| 277/ | 42 | 790/ MG | 200 | 8603/G | 224 |
| 300/ | 118 | 790/ MGS | 200 | 8603/I | 224 |
| 311/ | 117 | 790/ MI | 200 | 8603/P dx/sx | 224 |
| 312/ | 117 | 790/ MIS | 200 | 8605 | 216 |
| 370/ | 158 | 790/ MP | 200 | 8606 | 216 |
| 373/ | 158 | 790/ MPS | 200 | 8607 | 225 |
| 380/8 | 101 | 790/ SF | 200 | 8607/E | 225 |
| 399/10 | 104 | 799/ | 101 | 8607/G | 225 |
| 399/M | 104 | 799/T/ | 103 | 8607/I | 225 |
| 399/R/ | 104 | 799/TS/ | 103 | 8607/P dx/sx | 225 |
| 399/T/ | 103 - 189 | 799/U/ | 101 | 8608 | 217 |
| 399/TC/ | 103 - 189 | 4020/ | 106 | 8608/C | 201 - 217 - 219 |
| 399/U | 101 | 4026/ | 107 | 8610 | 45 |
| 419/ | 108 | 4030/ | 109 | 8611 | 45 |
| 422/AD | 108 - 182 - 183 | 4050/ | 133 | 8612/10 | 220 |
| 425/ | 108 | 4060/ | 133 | 8613 | 219 |
| 430/ | 105 | 4080/ | 133 | 8614 | 220 |
| 441/ | 105 | 4150/11/S | 168 | 8615 | 218 |
| 450/AD | 182 - 183 | 4170/ /S | 169 | 8616 | 218 |
| 455/ | 116 | 4300/ | 118 | 30046 | 267 |
| 457/ | 116 | 4311/ | 117 | 30049 | 267 |
| 461/ | 116 | 4312/ | 117 | 30052 | 267 |
| 470/ | 159 | 4399/R/10 | 104 | AF/1 | 51 - 207 |
| 473/ | 158 | 4399/T | 103 | AI/ | 28 - 96 - 191 |
| 474/ | 158 | 4701/ | 118 | AI/ /E | 28 |
| 476/ | 160 | 4711/ | 117 | AIF/ | 98 |
| 487/ | 158 | 4712/ | 117 | AIL/ | 28 |
| 499/T | 102 | 4720/ | 106 | AIP/ | 28 |
| 700/ | 118 | 4722/ | 106 | AIS/ | 28 - 96 |
| 701/ | 118 | 4726/ | 107 | AIS/ /E | 28 |
| 711/ | 117 | 4729/ | 107 | AIX/ | 28 - 96 |
| 712/ | 117 | 4730/ | 109 | AL/120/24 | 240 |
| 720/ | 106 | 4750/ | 133 | AL/150/24 | 240 |
| 722/ | 106 | 4760/ | 133 | AL/60/24 | 240 |
| 723/ | 109 | 4780/ | 133 | AL/90/24 | 240 |
| 724/ | 109 | 4799/T | 103 | AX/2/ | 41 |
| 726/ | 107 | 4799/TS | 103 | BH/20 | 93 |
| 729/ | 107 | 7100/ | 133 | BH/20/A | 93 |
| 730/ | 109 | 8181 | 221 | BI/40 | 63 |
| 732/SF/ | 118 - 185 | 8580 | 222 | BI/40/A | 63 |

| | |
|-------------|-----------|
| BL/ | 62 |
| BLA/ | 62 |
| BLAH/ | 62 |
| BP/20 | 93 |
| BP/20/A | 93 |
| BP/22 | 92 |
| BP/25 | 92 |
| BPK/20 | 93 |
| BPK/25 | 92 |
| BPT/20 | 93 |
| BPT/22 | 92 |
| BPT/25 | 92 |
| C/10/SF | 176 |
| C/13/SF | 176 |
| C/22/SF | 176 |
| C/4 | 180 |
| C/7/SF | 174 - 175 |
| CE/10/100 | 241 |
| CE/10/20 | 241 |
| CE/5/20 | 241 |
| CE/RGB/20 | 241 |
| CLA/ | 231 |
| CLA/8A | 231 |
| CLA/8P | 231 |
| CN28 | 265 |
| CPCI/55/ | 140 |
| CPCI/55/ /E | 141 |
| CPCI/55/ /G | 141 |
| CPCI/75/ | 140 |
| CPCI/75/ /E | 141 |
| CPCI/75/ /G | 141 |
| CPCI/95/ | 140 |
| CPCI/95/ /E | 141 |
| CPCI/95/ /G | 141 |
| CPCV/30/ | 142 |
| CPCV/30/ /E | 142 |
| CPCV/30/ /G | 142 |
| CPCV/55/ | 140 |
| CPCV/55/ /E | 141 |
| CPCV/55/ /G | 141 |
| CPCV/75/ | 140 |
| CPCV/75/ /E | 141 |
| CPCV/75/ /G | 141 |
| CPCV/95/ | 140 |
| CPCV/95/ /E | 141 |
| CPCV/95/ /G | 141 |
| CPCVF/55/ | 140 |
| CPEI/45/ | 146 |
| CPEI/45/ /E | 147 |
| CPEI/45/ /G | 147 |
| CPEV/45/ | 146 |

| | |
|-------------|-----------|
| CPEV/45/ /E | 147 |
| CPEV/45/ /G | 147 |
| CPEV/72/ | 146 |
| CPEV/72/ /E | 147 |
| CPEV/72/ /G | 147 |
| CPGV/55/ | 144 |
| CPGV/55/ /E | 144 |
| CPGV/55/ /G | 144 |
| CPHA/ | 148 |
| CPHV/ | 148 |
| CPHA/ /E | 148 |
| CPHV/ /E | 148 |
| CPLB | 149 - 257 |
| CPLB/2 | 149 - 257 |
| CPLV/ | 149 - 257 |
| CPLV/ /E | 149 - 257 |
| CPLV/ /G | 149 - 257 |
| CPNV/45/ | 143 |
| CPNV/45/ /E | 143 |
| CPNV/45/ /G | 143 |
| CPNVF/45/ | 143 |
| CPQV/50/ | 145 |
| CPQV/50/ /E | 145 |
| CPQV/50/G | 145 |
| CPQV/70/ | 145 |
| CPQV/70/ /E | 145 |
| CPQV/70/G | 145 |
| CR/N | 256 |
| D/4461/K | 266 |
| D/4471/K | 266 |
| DC1 | 265 |
| DC10 | 265 |
| DC2 | 265 |
| DC3 | 265 |
| DC4 | 265 |
| DC5 | 265 |
| DC7 | 265 |
| DCE4 | 263 |
| DF | 264 |
| DI/ | 99 |
| DIMM/02 | 240 |
| DJA/ | 99 |
| DJA/ /EI | 99 |
| DJAF/ | 99 |
| DJG/ | 99 |
| DJG/ /EI | 99 |
| DJK/ | 99 |
| DJK/ /EI | 99 |
| DJKC/10 | 52 |
| DJKG/10 | 53 |
| DJKGC/10 | 53 |

| | |
|----------|----------|
| DJN/ | 99 |
| DJN/ /EI | 99 |
| DJNF/ | 99 |
| DT1 | 265 |
| DT10 | 265 |
| DT2 | 265 |
| DT3 | 265 |
| DT4 | 265 |
| DT5 | 265 |
| DT7 | 265 |
| FIX/J/30 | 187 |
| FIX/J/44 | 186 |
| FIX/L/32 | 187 |
| FIX/L/55 | 186 |
| FIX/T/19 | 187 |
| FIX/T/33 | 186 |
| FL/C | 262 |
| FMA/ | 40 |
| FMAC/ | 40 |
| FMAE/ | 40 |
| FMAI/ | 40 |
| FMB/ | 40 |
| FMBC/ | 40 |
| FMBE/ | 40 |
| FMBI/ | 40 |
| FMI/ | 40 |
| FMIC/ | 40 |
| FMICS/ | 40 |
| FMIE/ | 40 |
| FMIES/ | 40 |
| FMII/ | 40 |
| FMIIS/ | 40 |
| FMIS/ | 40 |
| G/2/SF | 178 |
| G/4/SF | 179 |
| G/40/ | 132 |
| G/460/ | 132 |
| G/60/ | 132 |
| G/705/F | 190 |
| G/80/ | 132 |
| G/9/F | 234 |
| G/9P/DX | 234 |
| G/9P/SX | 234 |
| GA/ | 56 - 192 |
| GAN/ | 57 |
| GBL/ /C | 62 |
| GBL/ /E | 62 |
| GBL/ /I | 62 |
| GBL/ /T | 62 |
| GF/ | 159 |
| GG/2 | 82 |

| | | | | | |
|-----------|-----------|------------|-----------|-----------|-----------------------------|
| GG/3 | 82 | GTINX/I | 58 | L5/WW/33 | 240 |
| GG/4 | 82 | GTINX/T | 58 | L5/WW/67 | 240 |
| GIC/ | 60 | GTL/C | 63 | LA/I/ | 50 |
| GIN/ | 58 | GTL/E | 63 | LA/IS/ | 50 |
| GIN/ /SA | 58 | GTL/I | 63 | LB/A | 50 |
| GINS/ | 58 | GTL/T | 63 | LB/B/ | 50 |
| GINS/ /SA | 58 | GTP/C | 57 - 59 | LDA/ | 50 |
| GINX/ | 58 | GTP/E | 57 - 59 | LDAD | 51 |
| GINX/ /SA | 58 | GTP/I | 57 - 59 | LDAG/ | 50 |
| GJA/ | 131 | GTP/T | 57 - 59 | LDB/ | 50 |
| GJF/ | 131 | GTV/E | 56 | LDRS/ | 50 |
| GJS/10 | 131 | GTV/I | 56 | LDS/ | 50 |
| GM12/L | 125 | GU/30/ | 89 | LDT/ | 50 |
| GM/10 | 125 | GU/40/ | 89 | LDTM/ | 50 |
| GM/72 | 162 | GV/ | 56 | LDV/ | 50 |
| GM/78 | 163 | GVNH/ | 57 | LLA/20 | 230 |
| GM/I | 124 | GWA/ | 131 | LLA/20P | 230 |
| GM/R | 162 | H3502 | 166 | LLA/20/10 | 230 |
| GMP/I | 124 | H/5/F | 189 | LLA/30 | 230 |
| GMR/44 | 161 - 235 | IL/ | 46 | LLA/30P | 230 |
| GP/ | 59 | ILN/ | 46 | LLB/30 | 230 |
| GPS/6 | 82 - 83 | ILNS/ | 46 | LLB/30P | 230 |
| GPS1/ /19 | 82 | ILNX/ | 46 | LQL/2 | 232 |
| GPS14/12 | 83 | IP/40 | 44 | MIN/ | 41 - 115 |
| GPS2/ | 83 | IPA/ | 31 - 153 | NAN/ | 124 |
| GPS3/ /10 | 84 - 85 | IPB/ | 31 - 153 | NE/ | 122 |
| GPS3/ /11 | 84 - 85 | IPV/ | 31 | NF/ | 123 |
| GPS3/ /12 | 84 - 85 | IR/C01 | 241 | NIL/ | 125 |
| GPS4/ /10 | 86 - 87 | IR/C01NT | 241 | NIN/ | 125 |
| GPS4/ /11 | 86 - 87 | IR/C02 | 241 | NJ/ | 122 |
| GPS4/ /12 | 86 - 87 | IR/C03 | 241 | NL/ | 123 |
| GPS5/10/ | 88 | IR/W3 | 241 | NPAN/ | 124 |
| GPS5/11/ | 88 | JGA/ | 192 | NTA/ | 126 - 188 |
| GPS5/12/ | 88 | K10 | 266 | NTI/ | 126 - 188 |
| GPU/ | 59 | KL/1 | 262 - 263 | NTO/ | 126 |
| GR/80/ | 132 | KL/1A | 262 - 263 | NZA/ | 127 - 188 |
| GTA/E | 56 | KL/2 | 262 - 263 | NZS/ | 127 |
| GTA/I | 56 | KL/3 | 262 - 263 | NZS/A/40 | 127 |
| GTIN/C | 58 | KL/C | 263 | NZS/B/ | 112 |
| GTIN/E | 58 | KL/T1 | 262 | NZS/L/ | 127 |
| GTIN/G | 58 | KL/T2 | 262 | NZS/S1 | 112 |
| GTIN/I | 58 | KL/T3 | 262 | NZS/S2 | 112 |
| GTIN/T | 58 | KL/X1 | 262 | P/5 | 255 |
| GTINS/C | 58 | KL/X2 | 262 | P1/10 | 249 - 251 - 253 - 254 - 256 |
| GTINS/E | 58 | KL/X3 | 262 | P1/80 | 249 - 251 - 253 |
| GTINS/G | 58 | L5/NW/33 | 240 | PA/ | 113 |
| GTINS/I | 58 | L5/NW/65NT | 240 | PAE | 90 - 136 |
| GTINS/T | 58 | L5/NW/67 | 240 | PAI | 90 - 136 |
| GTINX/C | 58 | L5/NW/67NT | 240 | PAIG/ /15 | 91 - 136 |
| GTINX/E | 58 | L5/NW/67NT | 240 | PAIG/ /20 | 91 - 136 |
| GTINX/G | 58 | L5/RGB/67 | 240 | PAIG/ /28 | 91 - 136 |

| | | | | | |
|------------------------|----------------------------|-------------------|----------|--------------------|-----------------------|
| PAIG/ /38 | 91 - 136 | PT/6 | 181 | RR/5 | 266 |
| PAS/ | 129 | PT/6/SA | 181 | RT/ | 32 |
| POLISHING PASTE | 266 | PTC | 261 | RTM/ | 32 |
| PB30 | 90 - 136 | PTC/3000 | 261 | RV/ | 32 |
| PB5 | 90 - 136 | PTC1 | 261 | RVH/ | 32 |
| PBA/ | 114 | PTC1/3000 | 261 | S/15/SF | 176 |
| PBA/5/A | 188 | PTC1A | 261 | S/4 | 180 |
| PBAS/5/F | 189 | PTC1A/3000 | 261 | S/9/SF | 174 - 175 |
| PBE/ | 128 | PTC2 | 261 | S/95 | 201 - 209 - 210 - 212 |
| PBE30 | 137 | PTC2/3000 | 261 | S/97 | 213 |
| PBE5 | 137 | PTC3 | 261 | SA/ | 157 |
| PBH/ | 129 | PTC3/3000 | 261 | SA/G | 157 |
| PCC/01 | 256 | PTC4 | 261 | SAFETY-STEP | 166 - 167 |
| PCC/02 | 256 | PTLN | 261 | SAR/10/12 | 154 |
| PCC/03 | 256 | PTS | 261 | SAR/8/15 | 154 |
| PCC/04 | 256 | PTWN | 261 | SB/ | 157 |
| PCC/05 | 256 | PTWN/1400 | 261 | SB/G | 157 |
| PF12 | 90 - 136 | PV/ | 30 | SFL | 262 |
| PFFE/ | 130 | PWD12 | 137 | SGA/ | 152 |
| PHDE/ | 130 | PWP30 | 137 | SGA/11L | 234 |
| PI/ | 61 | QDC/1010 | 79 | SGA/11P | 234 |
| PIA/ | 61 - 192 | QDCC/1010 | 79 | SGI/ | 152 |
| PIN/ | 60 | QDI/1010 | 79 | SGK/ | 152 |
| PLAF/ | 115 | QDL/1010 | 79 | SGN/ | 152 |
| PN/ | 113 | RA/ | 32 - 191 | SIR/10/12 | 154 |
| PNI/ | 113 | RAS/ | 32 | SIR/8/15 | 154 |
| PNIS/ | 113 | RB/ | 32 | SIRS/10/12 | 154 |
| PP/ | 68 | RC/ /F | 185 | SIRS/8/15 | 154 |
| PP50/ | 68 | RC/411/CV | 185 | SIS/ | 155 |
| PP/96 | 93 - 137 - 208 - 226 - 266 | RC/415/CV | 185 | SIS/10/SF | 155 |
| PPL/5030/T | 250 | RC/47/CV | 185 | SIX/ | 155 |
| PPL/D4 | 253 | RC/49/CV | 185 | SKL/2 | 207 - 236 |
| PPL/DLB | 256 | RC/5/F | 189 | SLIM/ | 75 |
| PPL/DLT | 256 | RCF/ | 185 | SLIM-I/ | 75 |
| PPL/GM | 253 | RE/ | 38 | SM/ | 152 |
| PPL/GR | 253 | REC/ /100 | 39 | SMA/ | 152 - 190 |
| PPL/S | 256 | RECO/ /80 | 39 | SMART/ | 77 |
| PPL/T | 253 | RI/ | 34 - 191 | SMART3/ | 77 |
| PPL/TA | 253 | RIC/01 | 240 | SMART-I/ | 77 |
| PPL/TD | 250 | RIC/RGB/M | 240 | SN/ | 153 |
| PPL/TD/GR | 250 | RIC/RGB/S | 240 | SNG/ | 153 |
| PPL/TD/TT | 250 | RIL/ | 34 | SP/ | 156 |
| PPL/T2 | 251 | RIN/ | 35 | SP1 | 255 |
| PPL/T3 | 251 | RINS/ | 35 | SP2 | 255 |
| PPL/T4 | 251 | RINX/ | 35 | SP3 | 255 |
| PPL/TT | 253 | RIP/ | 34 | SS/4 | 266 |
| PR30 | 90 - 136 | RIS/ | 34 | SS/5 | 266 |
| PR5 | 90 - 136 | RIX/ | 34 | ST/7 | 126 |
| PROFLEX MACHINE | 267 | RKN/ | 36 | STA/ | 126 |
| PT/4 | 181 | RLN/ | 36 | STI/ | 126 |
| PT/4/SA | 181 | RPA/ | 37 | STO/ | 126 |

| | | | | | |
|------------|-----------|------------|-----------------------|-------------|----------|
| SWA/ | 156 | TPC/47/CV | 177 | ZK/ | 29 - 96 |
| SWB/ | 156 | TPS/410/CV | 177 | ZN/ | 96 |
| T/ | 175 - 176 | TPS/413/CV | 177 | ZNF/ | 98 |
| TA/ | 33 | TPS/47/CV | 177 | ZQAGN/ | 18 |
| TAS/ | 33 | TPU/ | 175 - 176 - 178 - 179 | ZQAGN/ /EI | 19 |
| TAT/ | 33 | TPZ/410/CV | 177 | ZQAL/10 | 233 |
| TATM/ | 33 | TPZ/413/CV | 177 | ZQAL/10B | 233 |
| TB/ | 33 | TPZ/47/CV | 177 | ZQAL/10P | 233 |
| TE/ | 38 | TU/6 | 175 - 176 - 178 - 179 | ZQAN/ | 18 - 191 |
| TEI/ | 38 | TV/ | 33 | ZQAN/ /EI | 19 |
| TEL/04 | 240 | UA/ | 100 | ZQAND/ | 22 |
| TEL/RGB/04 | 240 | UA/ /EI | 100 | ZQAND/ /EI | 22 |
| TGU/ | 89 | UG/ | 100 | ZQBN/ | 18 |
| THIN/ | 73 | UG/ /EI | 100 | ZQBN/ /EI | 19 |
| TIA/ | 33 | UI/ | 100 | ZQBRSN/ | 18 |
| TIAS/ | 33 | UI/ /EI | 100 | ZQBRSN/ /EI | 19 |
| TIAT/ | 33 | UIS/ | 100 | ZQBSN/ | 18 |
| TIB/ | 33 | UIS/ /EI | 100 | ZQBSN/ /EI | 19 |
| TIE/ | 34 | UK/ | 100 | ZQIM/ /EI | 23 |
| TIEL/ | 34 | UK/ /EI | 100 | ZQIMP/ /EI | 23 |
| TIEN/ | 35 | UKC/10 | 52 | ZQIMS/ /EI | 23 |
| TIENS/ | 35 | UKG/10 | 53 | ZQIN/ | 23 |
| TIENX/ | 35 | UKGC/10 | 53 | ZQIN/ /EI | 23 |
| TIEP/ | 34 | UN/ | 100 | ZQINP/ | 23 |
| TIES/ | 34 | UN/ /EI | 100 | ZQINP/ /EI | 23 |
| TIEX/ | 34 | VITI | 266 | ZQINS/ | 23 |
| TII/ | 34 | XLC/ | 77 | ZQINS/ /EI | 23 |
| TIIL/ | 34 | XLC3/ | 77 | ZQINX/ | 23 |
| TIIN/ | 35 | XLCC/ | 77 | ZQINX/ /EI | 23 |
| TIINS/ | 35 | XLL/ | 77 | ZQKN/ | 24 - 191 |
| TIINX/ | 35 | XPC/ | 69 | ZQKN/ /EI | 24 |
| TIIP/ | 34 | XPD/ | 71 | ZQLN/ | 24 |
| TIIS/ | 34 | XPF/ | 70 | ZQLN/ /EI | 24 |
| TIIX/ | 34 | XPI/ | 71 | ZQP/ | 25 |
| TIME/ | 35 | XSC/ | 75 | ZQP/ /EI | 25 |
| TIMI/ | 35 | XSCC/ | 75 | ZQTMN/ | 18 |
| TIV/ | 33 | XSL/ | 75 | ZQTMN/ /EI | 19 |
| TLA/10/C1 | 231 | XTC/ | 73 | ZQTN/ | 18 |
| TLA/10P/C1 | 231 | XTCC/ | 73 | ZQTN/ /EI | 19 |
| TLB/10/C1 | 231 | XTL/ | 73 | ZQVN/ | 18 - 20 |
| TLB/10P/C1 | 231 | XTT/ | 73 | ZQVN/ /EI | 19 - 21 |
| TOP/ /E | 47 | Z/1/SF | 174 - 175 | ZQVNH/ | 18 |
| TOP/ /ETM | 47 | Z/4 | 180 | ZTM/ | 26 |
| TOP/ /I | 47 | Z3/30/SF | 176 | ZV/ | 26 - 27 |
| TOP/ /ITM | 47 | ZA/ | 26 - 96 - 191 | ZVH/ | 26 |
| TOP/A/ | 47 | ZB/ | 26 | | |
| TOP/TM/ | 47 | ZBG/ | 97 | | |
| TPAE/ | 37 | ZBGF/ | 98 | | |
| TPAI/ | 37 | ZBS/ | 26 | | |
| TPC/410/CV | 177 | ZG/ | 96 | | |
| TPC/413/CV | 177 | ZGF/ | 98 - 190 | | |



Profilpas S.p.A.

via Einstein, 38
35010 Cadoneghe
(Padova) Italy

tel. +39 049 8878412
fax +39 049 706692

info@profilpas.com
www.profilpas.com

