

Roof

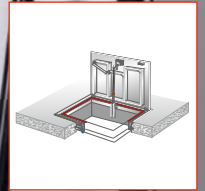

Floor

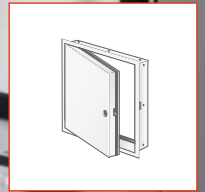

Wall

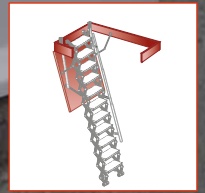

Stairs

Introduction

Access through roof, wall, floor and ceiling

Gorter, since 1928

Gorter Group started life as a manufacturer of metal window and door frames in 1928. Throughout the nineties, Gorter began to specialize in safe access solutions through roof, floor, wall and ceiling cavities. Gorter is now considered one of the world's leading manufacturers and suppliers of access products and the Gorter trademark is recognized as a sign of quality in building industries around the world. Gorter Group is represented in Europe, Australia, New Zealand, Asia and the Middle East.

CE

On all Gorter RHT, RHTG and RHTEP hatches an application for European Technical Approvals (ETA-15/0338, ETA-18/0287 and ETA-18/0831) have been lodged. The granting of an ETA is the base for CE marking. The CE mark is accepted throughout the European Union.

Insulation

Gorter roof hatches are the only ones in the roof access category with a proven high insulating value. An independent bureau has tested and confirmed the thermal performance according to EN ISO 10077-2.

Safety

Safety is approved according to International Health and Safety Regulations, EN1050, EN-ISO14122, EN131 and NEN2484 by Aboma, a qualified and licensed safety approving institution. The reports are useful documents in the risk and safety analysis of a building.

Safe access and more

Not only do Gorter access products provide safe, convenient access to a variety of spaces, they can be complemented with added option features such as explosion relief, fire rating, glazing, acoustic damping, electric operation and are available in a range of standard and custom sizes, materials and finishes.

Fire rating

The fire resistance has been assessed by Efectis in accordance with EN 1634-1, EN 13501-2, AS1530-4 and BS476: part22.

Quality

Gorter is an EN-ISO-9001: 2008 certified company.

General performance

The general performance is tested by Stichting Kwaliteit Gevelbouw (SKG) in Wageningen (NL). SKG is an European Notified Body No. 0960, accredited by the Dutch Accreditation Council according to ISO/IEC17025:2005 and EN45011:1998. All RHT roof hatches and combinations are certified by TÜV NORD.

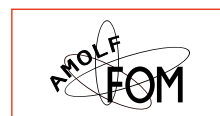

Performance	RHT	RHTG
Insulation value (EN-ISO 10077-2)	: $U_w \leq 0,319 \text{ W}/(\text{m}^2 \cdot \text{K})$	$U_w \leq 0,83 \text{ W}/(\text{m}^2 \cdot \text{K})$ HR+++ glass: $U \leq 0,500 \text{ W}/(\text{m}^2 \cdot \text{K})$
Acoustic damping (EN-ISO 717-1:2013)	: 26 dB	27 dB
Watertightness (EN 12208)	: Class E 650	Class E 650
Resistance to permanent loads (Eurocode EN 1993-1-1)	: 1050 kg/m ²	-
Air tightness (EN 1026)	: 0,5 m ³ /hm ¹	0,5 m ³ /hm ¹
Resistance to wind load (EN 12210)	: Class E 3000	Class E 2400
Resistance to snow loads (EN 1991-1-3)	: 3,97 kN/m ²	5 kN/m ²
Impact hard body (EN 13049)	: Class P5A	-
Impact soft body (EN 13049)	: Class 5	Class 3
Air permeability (EN 12207)	: Class 3	Class 4

Roof hatches

Access to flat roof spaces require optimal safety

International safety regulations limit, and in some cases even forbid, the use of ladders on the exterior facade of a building. Access to roof spaces higher than 10 meters with an exterior ladder is no longer permitted due to safety concerns. The safest and most convenient way to access the roof is by using the existing stairs or lift in the building to reach the top level, and ascending the last few meters with a safe and convenient to use interior access ladder/stair and roof hatch combination.



Safety of a Gorter roof hatch

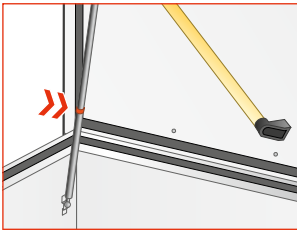

- » Single hand operation
- » Locks in open position

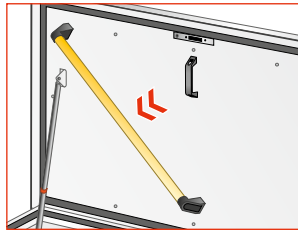

- » A safety handrail provides support during operation

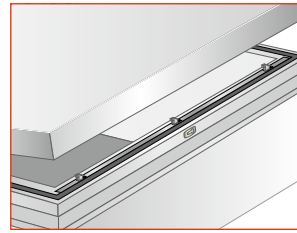

- » Closed cover eliminates danger of falling through open roof cavity
- » Cylinder lock with 3 point latch
- » Whole construction thermal Insulated

Installation

- » Concrete timber and steel roof
- » Roof pitch up to 30°

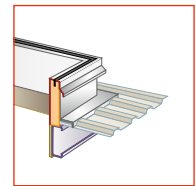
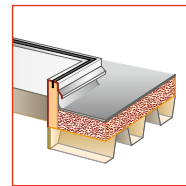
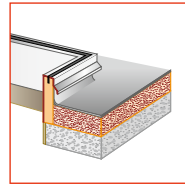
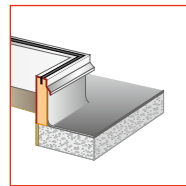
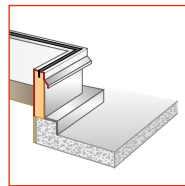

Robust and reliable

- » Whole construction thermal insulated
- » Durable wind and weather proof finish
- » Flexible gasket seal between curb and cover
- » Stainless steel hinges
- » Cylinderlock with Eurocylinder
- » Larger sizes with three point latch (>1500 mm)
- » Curb included
- » Aluminium construction anodized and powder coated
- » Suitable for coastal environments
- » Patent no. 2519072



Roof hatches - standard design and sizes

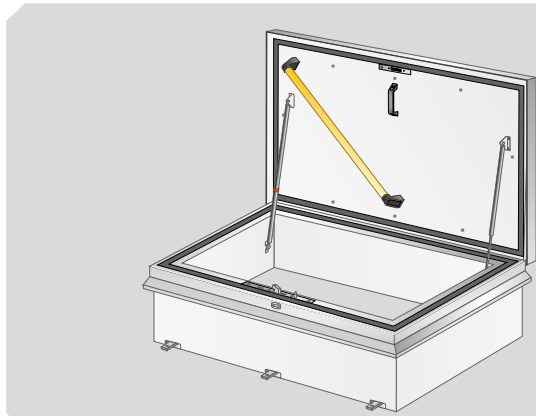

Standard aluminium roof hatches RHT

Type	Passage in mm ¹⁾	Weight
RHT7090	700 x 900	38 kg
RHT7010	700 x 1000	52 kg
RHT9090	900 x 900	44 kg
RHT7014	700 x 1400	52 kg
RHT1010	1000 x 1000	50 kg
RHT1015	1000 x 1500	65 kg
RHT1020	1000 x 2000	82 kg
RHT9024	900 x 2400	89 kg

¹⁾ Hinge side is noted in bold.

- » Thermal insulated
- » $U_w \leq 0,319 \text{ W}/(\text{m}^2 \cdot \text{K})$
- » In aluminium
- » Burglary resistance

Exterior	Interior
RAL 7047	RAL 9010

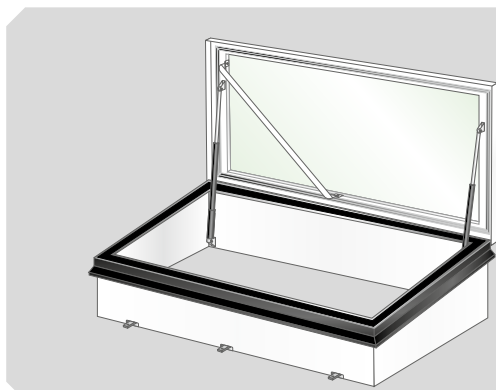

Standard glazed roof hatches RHTG ²⁾

Type	Passage in mm ¹⁾	Weight
RHTG1015	1000x 1500	163 kg
RHTG9024	900x 2400	221 kg
RHTG9030	900x 3000	268 kg

Exterior	Interior
RAL 9005	RAL 9010
RAL 9010	RAL 9010

¹⁾ Hinge side in bold. ²⁾ We do not recommend combinations of glazed roof hatches with scissor stairs. ³⁾ Do NOT walk on the glass.

- » Thermal insulated
- » HR+++ insulation glass ³⁾
- » $U_w \leq 0,83 \text{ W}/(\text{m}^2 \cdot \text{K})$
HR+++ glass: $U \leq 0,500 \text{ W}/(\text{m}^2 \cdot \text{K})$
- » In aluminium
- » Burglary resistance
- » Safety glass and Self cleaning
- » 2 powerful electric motors

Finish

Powder coated in two tone colour, with a cured dry layer thickness of 80 microns. Before powdercoating, a special surface protection layer is applied. Hatches are suitable for external exposure in coastal environments, and are highly resistant to corrosion from harsh conditions, such as high sun/wind/rain exposure environments.

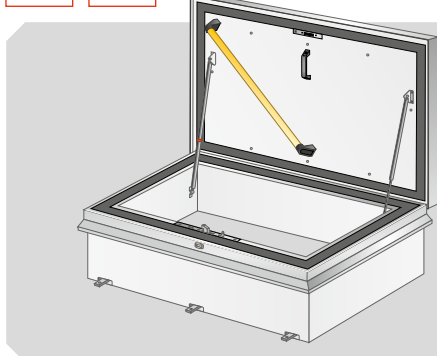

Roof hatch RHTEP - Energy performance

Type	Passage in mm ¹⁾	Weight
RHTEP7014	700x 1400	68 kg
RHTEP1015	1000x 1500	82 kg

¹⁾ Hinge side in bold.

Exterior	Interior
RAL 7047	RAL 9010

- » Thermal insulated
- » $U_w \leq 0,20 \text{ W}/(\text{m}^2 \cdot \text{K})$
- » Sound reduction $\geq 26 \text{ dB}$
- » In aluminium
- » Resistance to snow loads $3.97 \text{ kN}/\text{m}^2$
- » Resistance to permanent loads: $1050 \text{ kg}/\text{m}^2$
- » Burglary resistance

Options

- » Electric control

Roof hatches - special designs



Roof Hatch, 120 min. fire rated

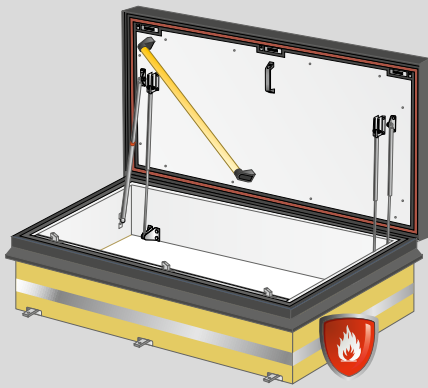

Type	Passage in mm ¹⁾	Weight
RHTEI7090	700 x 900	134 kg
RHTEI9090	900 x 900	157 kg
RHTEI7014	700 x 1400	185 kg
RHTEI1010	1000 x 1000	180 kg
RHTEI1015	1000 x 1500	236 kg
RHTEI1020	1000 x 2000	298 kg
RHTEI9024	900 x 2400	323 kg

Exterior	Interior
RAL 7011	RAL 9010

1) Hinge side in bold.

- » Fire rating class according to EN1634-1, EN13501-2, AS1530-4 and BS476:part22
- » E:120 minutes, EI₁:120 minutes, EI₂:120 minutes
- » KOMO:SKG.0372.0489
- » Efectis-R001575
- » In steel
- » Maximum dimensions: 900 x 2400 mm
- » TÜV SÜD PSB CLS1B 170697595001
- » **Close fire doors after use and keep closed!**

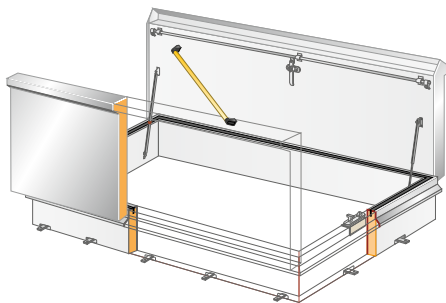

Roof hatches - special sizes

- » Constructed from aluminium and thermal insulated
- » Sizes up to approx. 4500 x 1200 mm will be supplied with single cover (>3000 mm with electrical operation).
- » Larger sizes will be supplied with two flat (or optionally inclined) covers
- » Unless otherwise specified, the longest side will be the hinge side
- » Fully assembled curb included for easy installation
- » Larger roof hatches with single lid are provided with a two or three point latch
- » Roof hatches with two covers only with two point latch

RHT liftable hatch

- » Gorter liftable hatches are fitted with two or more lids depending on the dimensions.
- » The hatches do not have hinges but can be lifted with a crane by means of the lifting eyes (4 per hatch).
- » When the lids are removed, there is a clearance in the roof through which material can be brought inside.
- » The lifting hatches can be used on flat roofs.

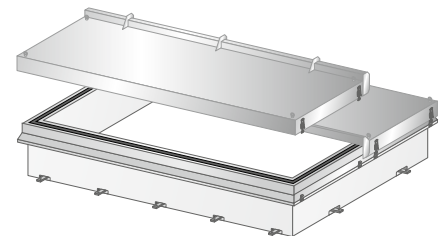

Roof hatch as an explosion vent - RHTX

Roof hatches type RHT1010, RHT1015 and RHT1020 can be equipped with an Explosion Release Control (ERC), patent no. 1870542. The ERC releases if the pressure on the inside cover exceeds approx. 100 kg force (Report Institute for Atomic and Molecular Physics, AMOLF, Amsterdam). The explosion venting roof hatch is only available in aluminium. Always keep vent opening free on both sides from obstacles that might obstruct performance.

- » Actual standard: EN1991-1-7:2006
- » The vent opening must be calculated by a recognized and specialized building and construction engineer

Acoustic damping

- » Standard sound reduction: 26 dB

Burglary resistant

Roof hatches can be supplied with extra security features such as a burglary resistant cylinder lock or high strength stainless steel construction. A Burglary resistant cylinder lock offers increased protection according to EN1303 and EN12209. Roof hatches >1500 mm will be supplied with a three point lock. Roof hatches in stainless steel are also an option.



Gorter safe access combinations

Gorter patented access combinations consisting of a roof hatch and ladder/stair are certified safe. Safety reports, available as a document, substantiate the safety of Gorter roof access solutions and can be used as proof of compliance for any required Risk Inventory and Evaluation.



Gorter combination: roof hatch + scissor stairs (attic ladder)

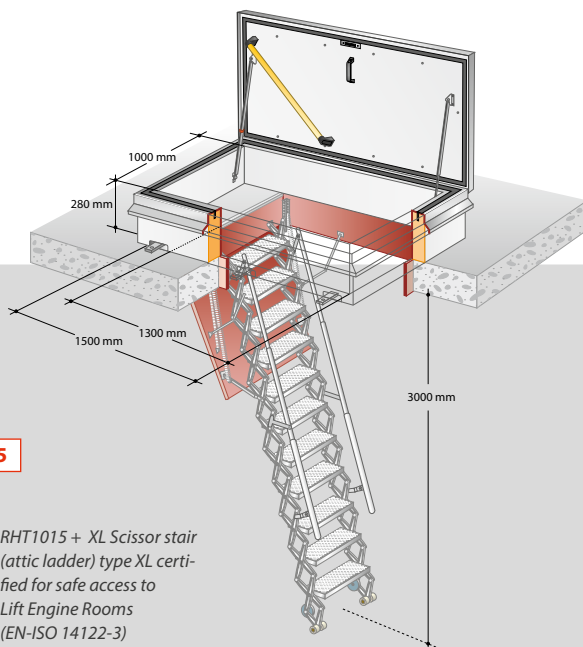

5

» RHT1015 + XL Scissor stair (attic ladder) type XL certified for safe access to Lift Engine Rooms (EN-ISO 14122-3)

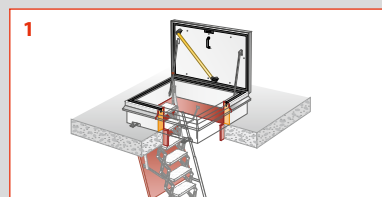

» RHT7090 + Small

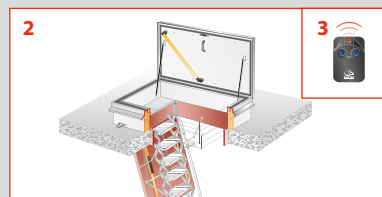

» RHT7014 + Large

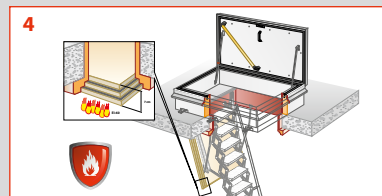

» RHT7014 + EI-60
Fire rating class EI-60

Type	Passage in mm ¹⁾	Stairs type	Structural opening in mm
1	700 x 900	Small	700 x 900
2	700 x 1000	S+	700 x 1000
3	700 x 1400	Large	700 x 1200
4	700 x 1400	Large electric ²⁾	700 x 1200
5	700 x 1400	Large EI-60 ³⁾	700 x 1200
6	1000 x 1500	XL	1000 x 1300

1) Hinge side is noted in bold. 2) 230 Vac, including control unit and wireless RF remote control. 3) Fire rating EI-60 (60mins).

» All scissor stairs are TÜV NORD certified according to EN 14975:2010

» Scissor stairs Large EI60: KOMO:SKG.0372.0457

» Fire rating class according to EN 1634-1

For more information about scissor stairs and the extension of scissor stairs see pages 16 to 18.

Plenum extension of scissor stairs for suspended ceiling applications

Type Large, EI-60 and XL can be safely extended to bridge the distance between a suspended ceiling and a roof hatch.

» Dutch patent no. 2000298

» Type Small, EI60 and Large Electric are not extendable

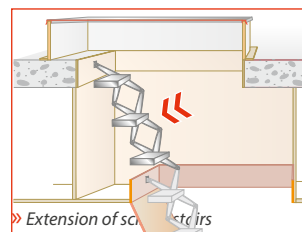

» Extension of scissor stairs



Gorter combination: roof hatch + safety hook-on ladder

All Gorter roof hatches can be safely combined with a Gorter safety hook-on ladder. During use, the Gorter safety hook-on ladder, type EL (single) or OL (double/triple), is hooked over a fixed anti-skid step mounted in the ceiling/roof cavity.

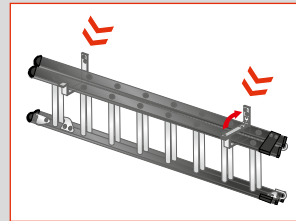
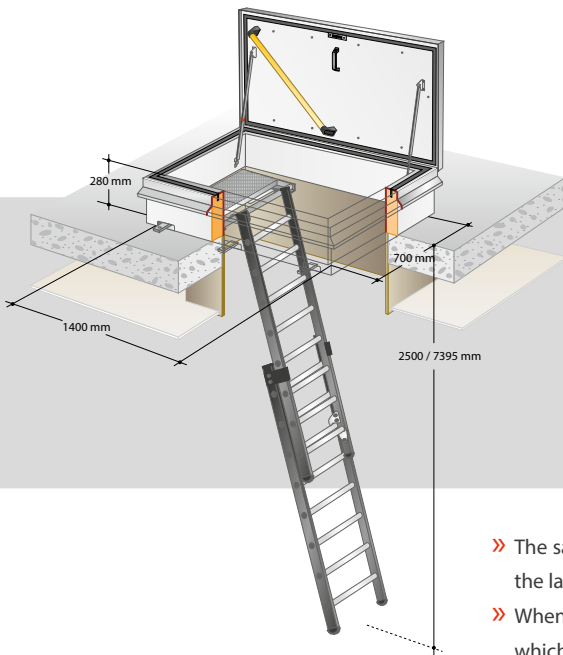
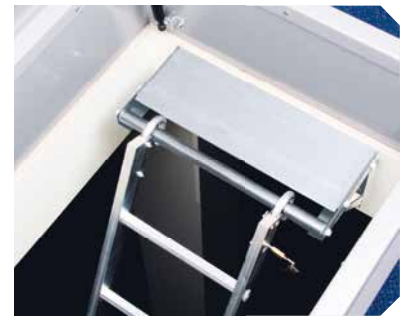

» Wall mount brackets

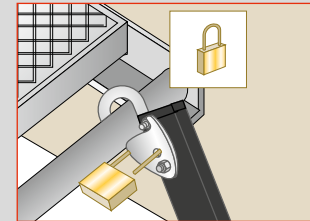

» Hook-on system with padlock provision

- » The safety hook-on ladder is equipped with padlock provision (padlock not included) to allow the ladder to be locked into place to prevent unauthorized removal or slipping whilst in use
- » When not in use, the ladder can be hung on two wall suspension brackets (included), one of which is equipped with padlock hasps to prevent theft/unauthorized use
- » Ladders are manufactured from anodized aluminium and fitted with anti skid treads

Gorter combination: roof hatch + fixed step ladder

Gorter fixed step ladders are designed for use in combination with a roof access hatch. Gorter fixed step ladders are suitable for all applications requiring safe access to a roof/ceiling space by a step ladder or stairway. Please contact your local office to confirm compliance with local building codes and laws.

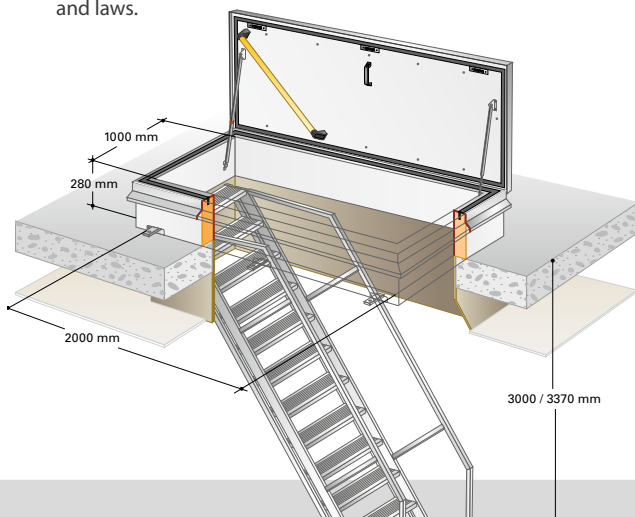

- » Designed to have a modern, aesthetically pleasing appearance
- » Easy to assemble on site
- » Depending upon the situation, the slope can be adjusted from 55° - 65°
- » Anti-skid steps as a standard
- » Anodized aluminium
- » GS55: Dutch patent no. 2007133



Roof Hatch Type	Passage in mm ¹⁾	Step ladder type
RHT1015	1000 x 1500	GS50 ²⁾
RHT1020	1000 x 2000	GS50 ²⁾ /GS55 ³⁾
RHT9024	900 x 2400	GS50 ²⁾ /GS55 ³⁾
RHTG1015	1000 x 1500	GS50 ²⁾
RHTG9024	900 x 2400	GS50 ²⁾ /GS55 ³⁾
RHTG9030	900 x 3000	GS50 ²⁾ /GS55 ³⁾



1) Hinge side is noted in bold.
 2) Floor to Roof height GS50 : 2500 mm (50°) - 3000 mm (66°)
 3) Floor to Roof height GS55 : 3000 mm (55°) - 3370 mm (65°)

Why are Gortex combinations safe?

- » A safe handrail is provided along the entire route to the roof
- » Scissor stair attic ladders have adjustable anti-skid steps
- » Safety hook-on ladders have anti-skid rungs
- » Safety hook-on ladders and stairs cannot slide away
- » Safety hook-on ladders and stair can be locked to prevent unauthorized removal
- » The entire route is free from sharp obstacles which may cause injuries or hinder access
- » The roof hatch can be opened and closed using one hand
- » The roof hatch automatically locks in the open position and can be released with one hand
- » A diagonal hand rail is provided on the internal cover to safely access and exit the roof hatch
- » Fall prevention: keep cover shut while on the roof to prevent fall hazard through open roof cavity.



» Locked during use



» Closed cover prevents against accidental falls

Safety reports are not applicable to combinations of a roof hatch with a ladder or retractable stairs supplied by third parties.

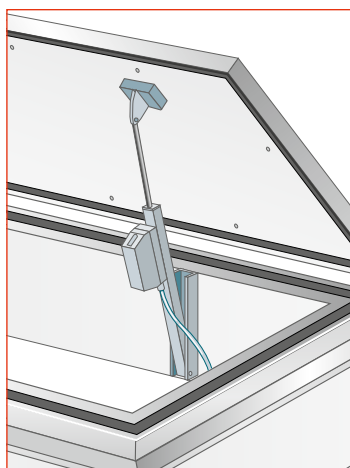

Electrical operation

Roof hatches can be supplied with either 24 V DC or 230 V AC electrical operation. Electrical operation (24 V DC) can be provided with a control box to enable connection with central alarm systems and indicators, such as rain or storm detectors.

For emergency exits, the control box can be fitted with batteries to ensure power supply in case of mains failure.

Hatches with two covers are supplied with at least two motors and an electronic closing sequence regulator in the control box.

Installation, connection and cabling must be carried out by a licenced electrician.

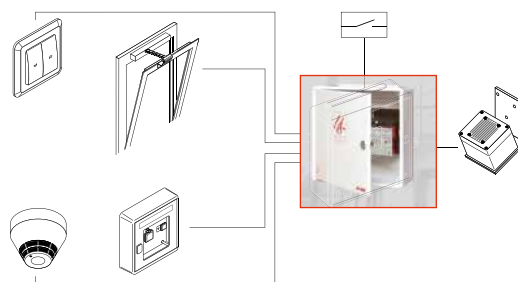

Floor doors

Floor doors can be supplied with a hinged (WA and OP) or detachable cover (VL and PT). The cover is finished flush with the surface of the floor. A surface mounted model (OP) is also available.

Flush covers are manufactured from checkerplate. The recessed cover for infill with flooring material is manufactured from aluminium sheeting. Depending on the size, hatches are supplied with single or dual lids. Floor doors are supplied fully assembled with frame and cover. Depending on the model, the frame is provided with integrated anchors all around the perimeter, or welded adjustable anchors. Custom floor doors can be manufactured for retrofitting in concrete or framed floors.

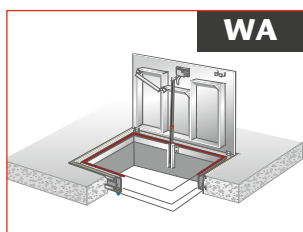

» Hinged floor door with one cover

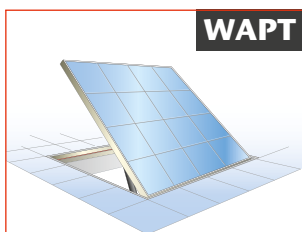

» Floor door with recessed cover for infill with flooring material



» Floor door with glass cover



» Floor door - 120-min. fire rated

Features of hinged floor doors, flush

WA

In and outdoor application

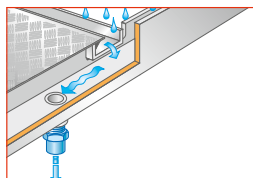

All aluminium models are suitable for indoor and outdoor use. The water draining frame is prepared for mounting a $\varnothing 40$ mm u-PVC socket to connect to the drain system.

In combination with ladder or stairs

Depending on the opening size and specific building site situation, hinged floor doors can be combined with a fixed vertical ladder, safety hook-on ladder, or retractable/fixed stairs.

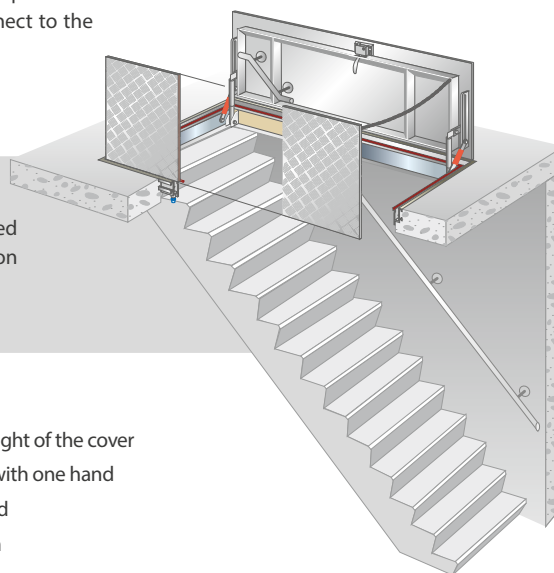

Safe and user-friendly

- » Smooth and comfortable one-hand operation, regardless of the size and weight of the cover
- » The counter-balance system offers assisted opening and controlled closing with one hand
- » The cover automatically locks in an open position and releases with one hand
- » A diagonal safety hand rail will be supplied for types with a length > 600 mm
- » Anti-skid checkerplate lid with flush hand grip

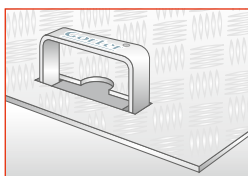
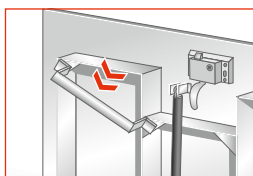
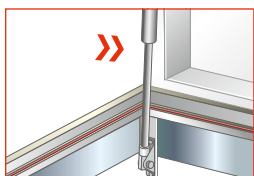
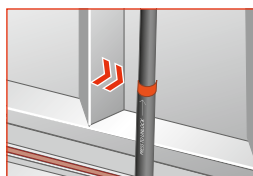

Load of hinged, flush floor doors

The load meets the most severe conditions of EN1991-1-3: 2003 and AS1170-1. The calculations are based on safety class 3, $Y_f; q; u = 1,5$ and Roark's Formulas for Stress and Strain, 7th Edition, Table 11.4 – Case 1a – Plate, all edges simply supported, uniform loaded.

- » The cover reinforcing is considered as beams on two supports
- » Application in situations with frequent dynamic loading is not recommended

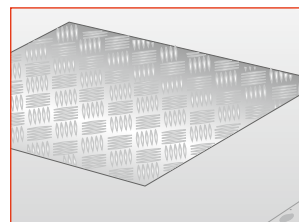

Electrical operation

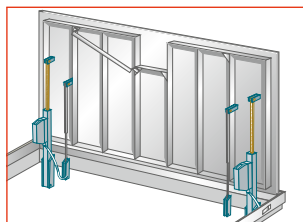

WA and WAPT can be supplied with 24 V DC or 230 V AC electrical operation. Electrical operation (24 V DC) can be extended with a control box to enable connection with central alarm systems.

For emergency exits, the control box can be fitted with batteries to ensure power supply in case of mains failure. The control box keeps the batteries charged and is programmable for a range of functions. Floor doors with two covers are supplied with at least two motors and the control box has a sequence regulator to close the covers in the correct order. Installation, connection and cabling must be carried out by a licenced electrician.

Standard design

WA

With anti skid checker plate - type WA

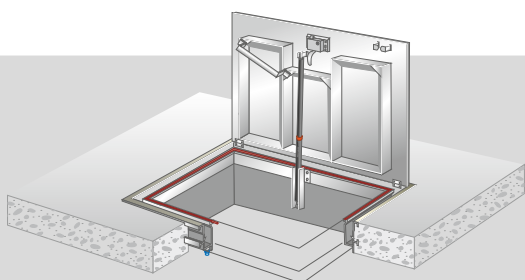

Custom sizes

Custom sizes are available.
Models > 1000 x 2500 mm will be supplied with 2 covers.

Standard sizes in mm ¹⁾

600 x 600	1000 x 1500
800 x 800	1000 x 2000
1000 x 1000	

¹⁾ Hinge side is noted in bold.

Load

15 kN per m² according to EN 1991-1

Finish

» Mill finish anodised aluminium

Options:

» Powder coated in RAL colour

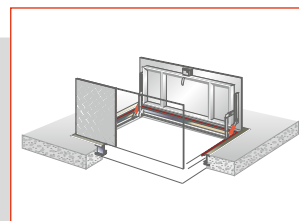

WA = water draining frame
E = with 1 cover
D = with 2 covers

- » Available as an emergency door
- » Available with an insulated cover

With recessed cover for infill with flooring material - type WAPT

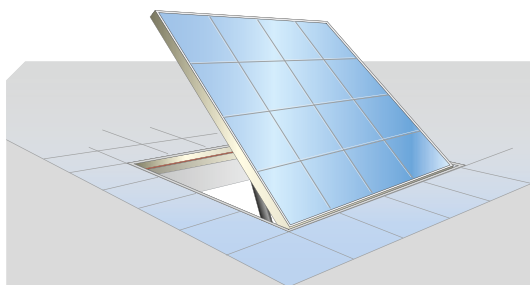

Custom sizes

Custom sizes are available.
Models > 1000 x 2500 mm will be supplied with 2 covers.

Standard sizes in mm ¹⁾

600 x 600	1000 x 1500
800 x 800	1000 x 2000
1000 x 1000	

¹⁾ Hinge side is noted in bold.

Load

5 kN per m² according to EN 1991-1

Finish

» Mill finish anodised aluminium

Options:

» Powder coated in RAL colour



WA = water draining frame
E = with 1 cover
D = with 2 covers

PT = recessed cover for infill with ceramic tiles, carpet or timber

Glass floor door WAG

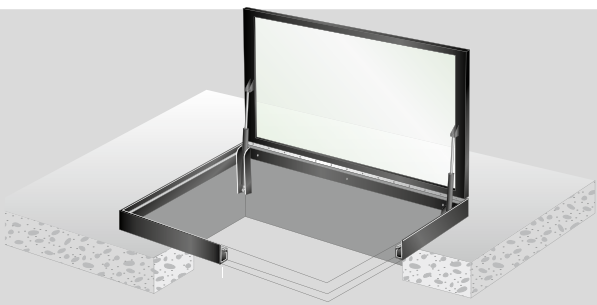

Standard sizes in mm ¹⁾

1000 x **1000** 1000 x **2000**

1) Hinge side is noted in bold.

Material

- » Safety glass with fall protection
- » Glass can be walked on
- » Robust stainless steel hinges
- » Flush glass plate
- » WA = water draining frame
- » 2 powerful electric motors

Glass floor doors are supplied in:

RAL 9005

Performance

- » Load up to 750 kg/m² according to din 18008-5 / EN1991 when closed
- » Maximum point load of 500 kg per 50x50 mm

Finish

- » Standard finish powder coating RAL 9005

Floor door WAEI 120 min. fire rated



EN 1634-1

EN 13501-1

AS 1530-4

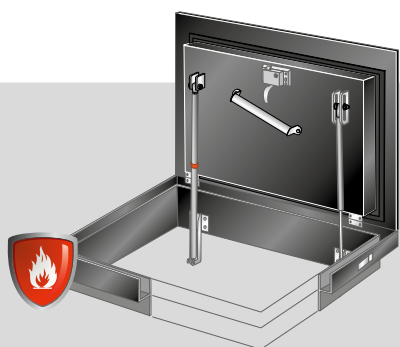

Standard sizes in mm ¹⁾

600 x **600** 1000 x **1500**
 800 x **800** 1000 x **2000**
 1000x **1000**

1) Hinge side is noted in bold.

Material

- » Fire rated floor doors are manufactured from steel
- » WA = water draining frame

Finish

- » Pre primed
- » Standard finish powder coating RAL 9005

Fire rated floor doors are supplied in:

RAL 9005

Options

- » Powder coated in a special RAL-colour

Performance

- » According to EN1634-1, EN13501-2, AS1530-4 and BS 476-22:1987.
- » KOMO:SKG.0372.0488
- » Efectis-R000702
- » TÜV SUD PSB CLS1B 170697595002
- » **Close fire doors after use and keep closed!**

Custom sizes

Maximum dimensions: 1000 x 2000 mm

EW: 120 minutes

El₁: 30 minutes

El₂: 45 minutes



Hinged floor doors - surface mounted, in aluminium

OP

» Type OP

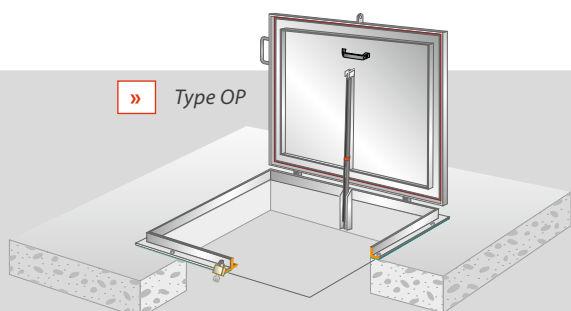

Standard sizes in mm ¹⁾

800 x **800** 1000 x **1500**
 1000 x **1000** 1000 x **2000**

1) Hinge side is noted in bold.

Types

- Type OP:** with checker plate cover
- Type OP-S:** OP + fall protection
- » Mill finish anodised aluminium

Load

5 kN per m² according to EN 1991-1

Options:

Type OP-D: with 2 covers

Custom sizes

Custom sizes are available.

Installation

On floor or pit surface.



Floor doors with detachable cover, non-hinged

Gortier Floor Doors with detachable covers offer an economically convenient solution in situations where the door is not used frequently and the specified sizes are minor.

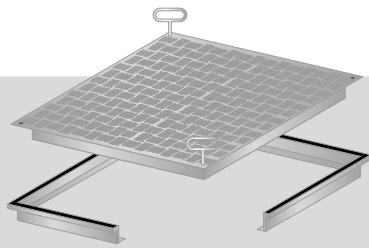
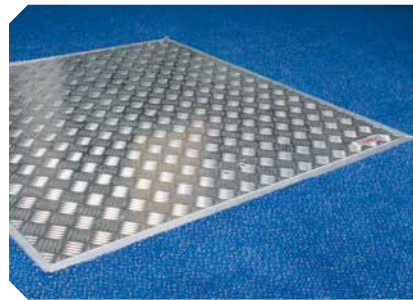

» RVA

Types

- RVA : flush, aluminium, with checker plate cover
- RV : flush, galvanised, checker plate cover
- BV-FL : galvanised steel, 27 mm recessed for infill
- BV-FL-THERMO : galvanised steel, 27 mm recessed for infill, insulated
- BV : galvanised steel, 50 mm recessed for infill
- BV-THERMO : galvanised steel, 50 mm recessed for infill, insulated
- BVA : aluminium, 65 mm recessed for infill

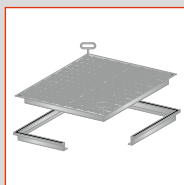

» RVA



» RV

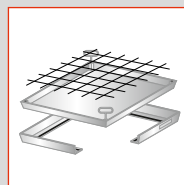

» BV-FL

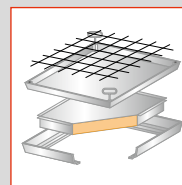

» BV-FL-THERMO

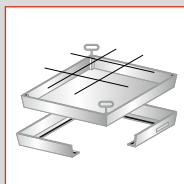

» BV

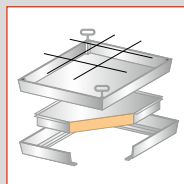

» BV-THERMO

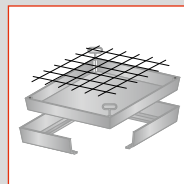

» BVA



Standard dimensions Passage in mm	Type						
	RVA	RV	BV-FL	BV-FL-THERMO	BV	BV-THERMO	BVA
500 x 500	-	-	-	●	-	●	-
600 x 400	●	●	●	-	●	-	●
600 x 600	●	●	●	●	●	●	●
800 x 600	●	●	●	●	●	●	●
800 x 800	●	●	●	●	●	●	●
1000 x 600	●	-	●	●	●	●	●
1000 x 1000	●	●	-	-	-	-	-

● = available, - = not available

Load RVA, RV, BV-FL: 15 kN/m²

Load BV, BVA: 125 kN/m²



Wall and ceiling doors

Wall and ceiling doors allow access to ducts, cable shafts and spaces that are otherwise not accessible for service and repair.

Material

Wall and ceiling doors are made of KTL (cathodic dip painting) treated steel and have a powder coating finish in RAL 9010.

Hardware

All doors are manufactured with a CAM lock.



Wall and ceiling door type Universal



» Type U

Standard sizes in mm

250 x 250	600 x 600
400 x 400	600 x 800
500 x 500	800 x 800

Material

» KTL (cathodic dip painting)
treated steel

Finish

» Powder coating :
RAL 9010

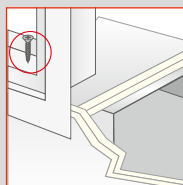

» In stud wall

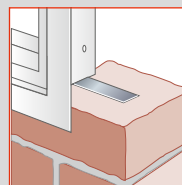

» In brick wall

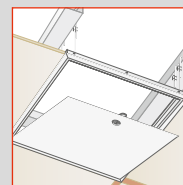

» In ceiling

Wall door type B, fire rated 120 minutes



EN 1634-1

EN 13501-2



» Type B

Standard sizes in mm

400 x 400	600 x 800
600 x 600	800 x 800

Material

» KTL (cathodic dip painting)
treated steel

Finish

» Powder coating :
RAL 9010

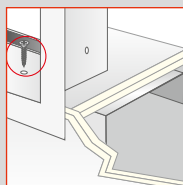

» In stud wall

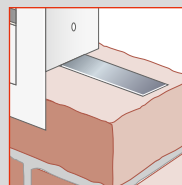

» In brick wall

E: 120 minutes
EI₁: 20 minutes
EI₂: 60 minutes
EW: 120 minutes

» Fire rating according to EN1634-1 en EN13501-2
» Efectis-R01165
» **Close fire doors after use and keep closed!**



Type EXW - Explosion vents

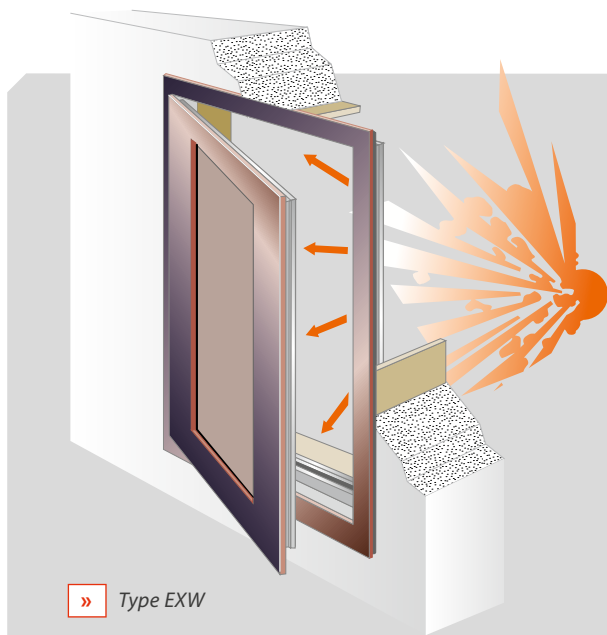

» Type EXW

Finish

Powder coated to any colour specification, standard dry layer thickness 60 micron.

Calculation of the vent opening

The size of the vent opening must be calculated by a certified engineering company in accordance with local building codes.

» Actual standard: EN1991-1-7:2006

Explosion vents are designed for installation in external vertical walls or facades. The door and door frame are made of an extruded aluminium profile with a thermal break. The door has an infill of a double-faced aluminium sheet with hard foam. The door opens to the outside.

Sizes

Explosion vents are made according to specification.

Explosion Release Control (ERC)

The explosion vent frame is provided with an Explosion Release Control (Patent No. 1870542). The door is provided with a cylinder lock with Euro cylinder operated from the inside. If the pressure on the inside door leaf exceeds approx. 100 kg-force the ERC will release. The ERC is tested and approved by AMOLF, the Institute for Atomic and Molecular Physics in Amsterdam.

Note: if the door is pulled from the outside with the same power as the release power, the ERC will open.



» Explosion Release Control



Ladders and scissor stair (attic ladders)

Gortor safety hook-on ladders and scissor stair (attic ladders) are safe and easy to use and are manufactured from top quality materials to guarantee optimal reliability and a long service life.

Safety hook-on ladders and scissor stair (attic ladders) are approved for safety, construction strength and operation by certified international safety approval institutions.



Hook-on ladders

Hook-on ladders are supplied to the specified room height in single (EL), double (OL2) or triple (OL3) designs.



- » Hook-on ladders are made in accordance with EN131
- » Standard anodized aluminium

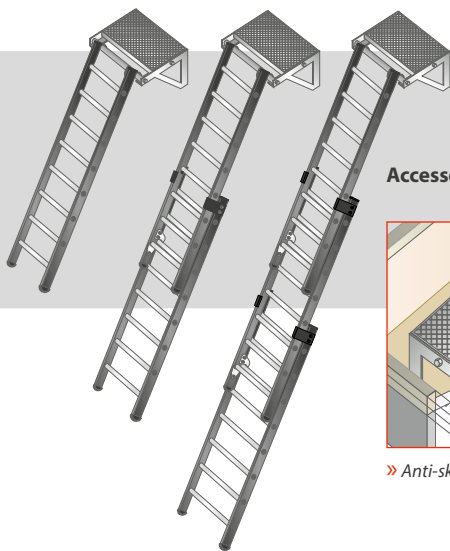

Accessories

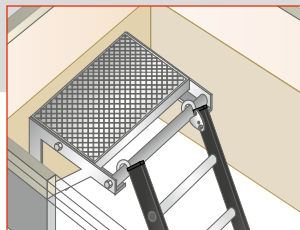

» Anti-skid, hook-on transfer step

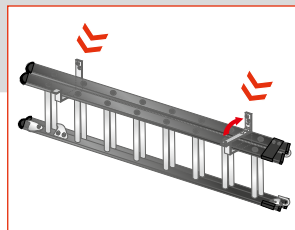

» Suspension wall brackets

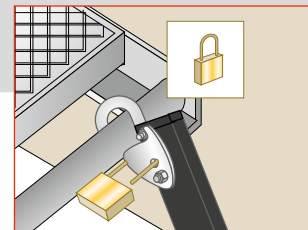

» Padlock provision



Scissor stair (attic ladders)

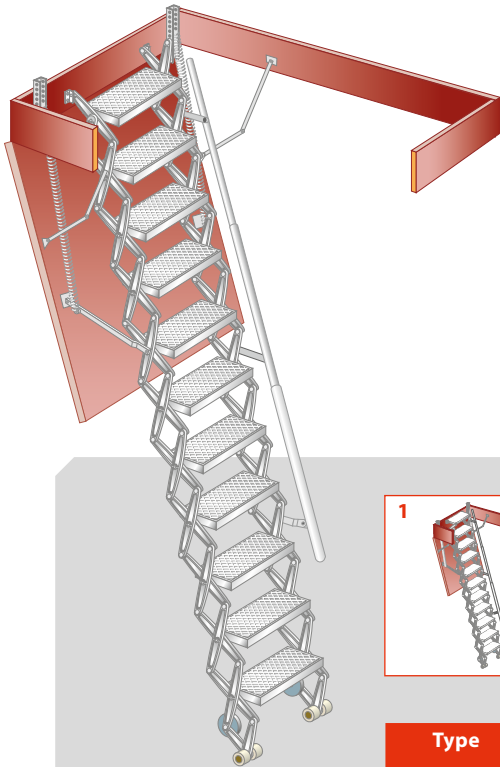

2 Type Large

Retractable scissor stairs (attic ladders) consist of a casing with a wooden ceiling panel. A telescopic hand rail is included and easy to install. The scissor stair is attached to a hinged ceiling panel and is made of cast aluminium. A hook-on rod is included.

Gorter scissor stair (attic ladders) are manufactured from top quality materials and designed to provide a safe, durable and reliable access solution that is load tested upto 260 kg.

Safety

- » Counterbalanced for practically effortless operation. An exertion of less than 3kg of force is required.
- » Adjustable anti-skid steps
- » Hand rail can be mounted on the left or right
- » Prepared for securing with a padlock
- » Safety approved: TÜV NORD certificate

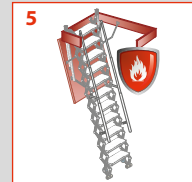
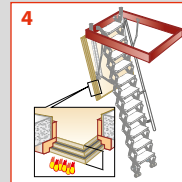
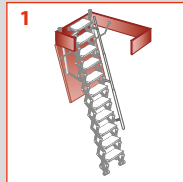

Type	Structural size (w x l x h) in mm	Step size (w x d) in mm
1 Small	700 x 900 x 320	350 x 140
1 S+	700 x 1000 x 320	350 x 140
2 Large	700 x 1200 x 250	350 x 140
2 Large-H	700 x 1200 x 250	350 x 140
3 Large Electric ¹⁾	700 x 1200 x 250	350 x 140
3 Large-H Electric ¹⁾	700 x 1200 x 250	350 x 140
4 Large EI-60 ²⁾	700 x 1200 x 250	350 x 140
4 Large-H EI-60 ²⁾	700 x 1200 x 250	350 x 140
5 XL ³⁾	1000 x 1300 x 250	480 x 140
5 XL-H ³⁾	1000 x 1300 x 250	480 x 140

- » All scissor stairs are TÜV NORD certified
- » Scissor stairs Large EI60: KOMO:SKG.0372.0457
- » Fire rated according to EN 1634-1

1) 230 Vac, including control unit and wireless RF remote control.
 2) Fire rating class EI 60, KOMO:SKG0372.0457
 3) With two hand rails. RHT1015 Certified for Access to Lift Engine Rooms according to EN 14122-3 and EN 14975.

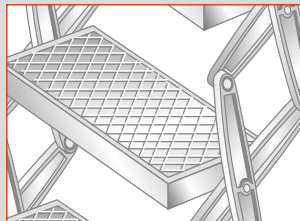

» Adjustable anti-skid steps

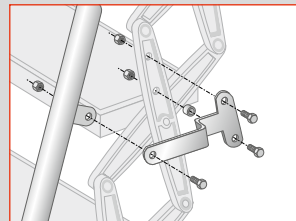

» Hand rail on left or right side

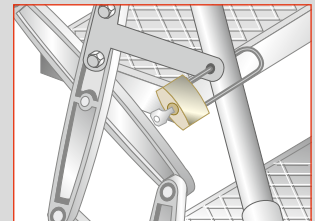

» Padlock provision

Dimensions

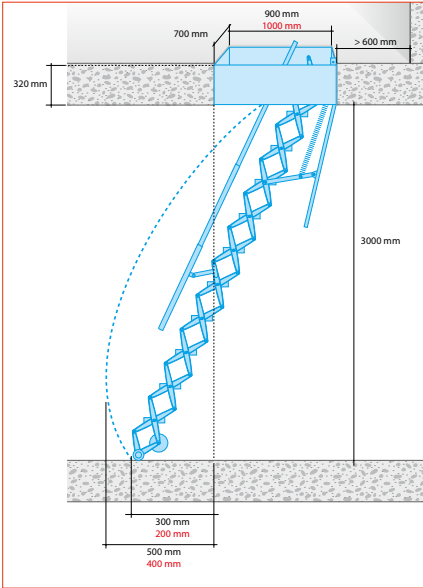

» Type Small and S+

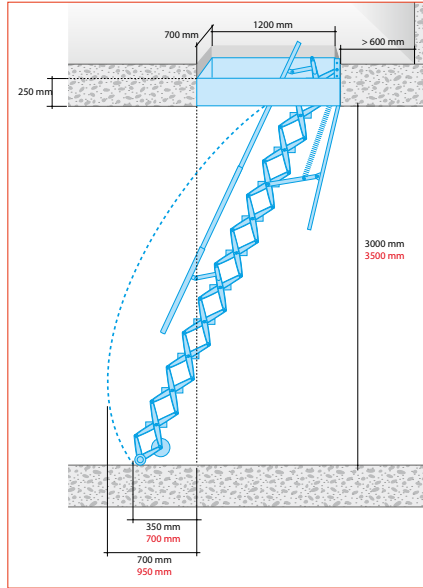

» Type Large and Large H

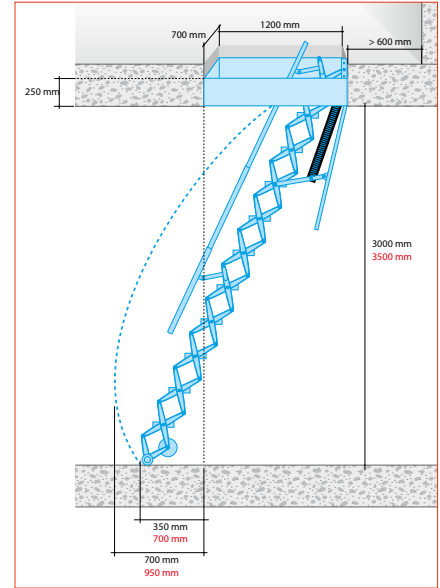

» Type Large Electric and Large-H Electric

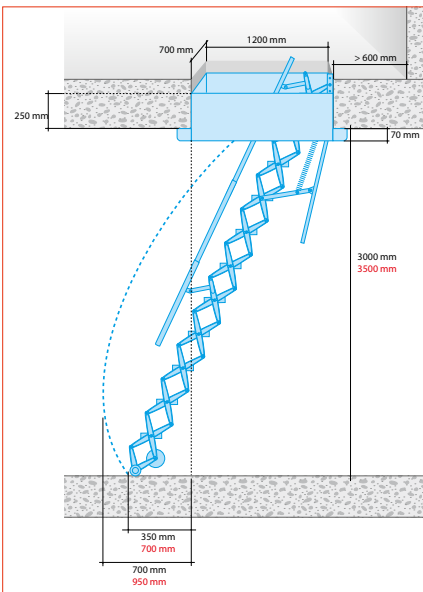

» Type Large EI-60 and Large-H EI-60

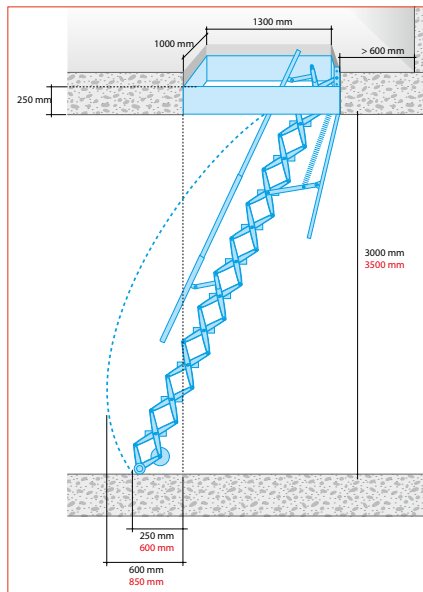

» Type XL and XL-H



Extension of scissor stair (attic ladders) for use in suspended ceilings

In applications where the stair is fixed into a suspended ceiling, a plenum extension is necessary to bridge the distance between the suspended ceiling and the roof hatch. The stairs are extended upwards with two or more steps, without any change to the gradient. This provides a safe access solution without the need for vertical steps.

- » Type Small, S+, EI60 and Large Electric are not extendable
- » An Aboma Safety report is available
- » Dutch patent no. 2000298



» Extension of scissor stairs (plenum 3)

Dimensions

For type Large

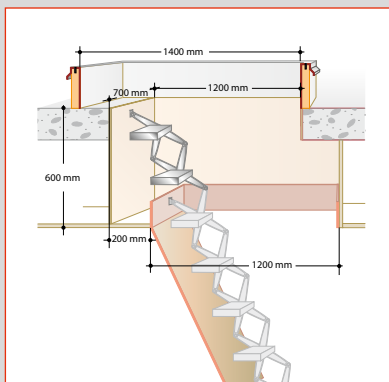

» Plenum 2

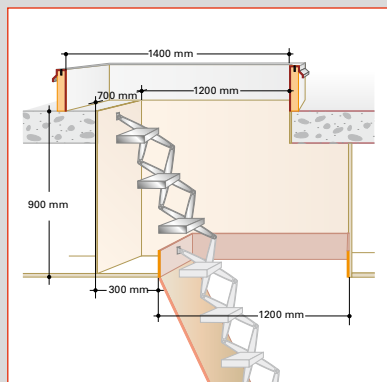

» Plenum 3

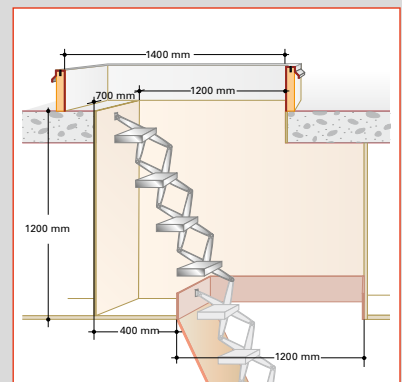

» Plenum 4

For type XL

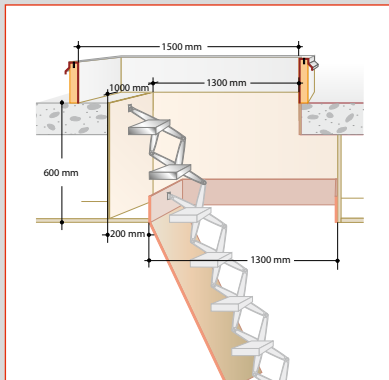

» Plenum 2XL

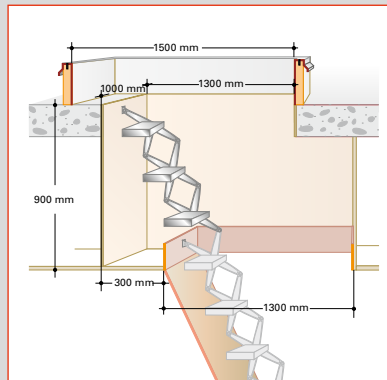

» Plenum 3XL

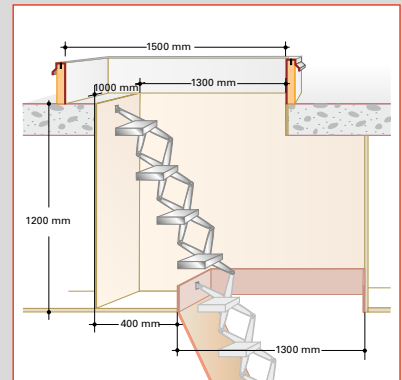

» Plenum 4XL



Fixed vertical ladders, with or without safety cage

EN-ISO
14122-4

AS
1657-1992

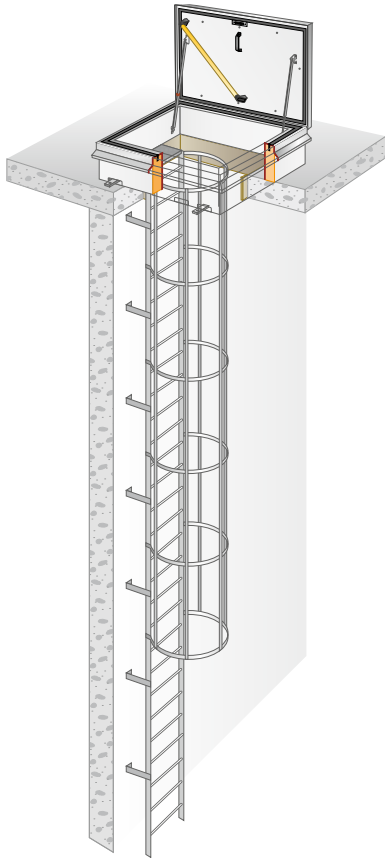

Fixed ladders are supplied with a pre-assembled cage with five strips (cage if applicable) and ladder supports for fixing to the external wall of the building.

Safety

- » A safety cage (ø 700 mm) will be necessary from a height of 2200 mm or if the ladder is situated less than 3 metres from a difference in ground level
- » If the difference in level is > ten metres an intermediate platform is needed
- » If the difference in level is > ten metres the ladder sections between intermediate platforms must be less than six metres
- » In applications where the cage ladder is fixed onto an external facade a step-over platform is necessary to safely access the roof
- » At ground level the ladder must be lockable to prevent damage and unauthorised access
- » The step-over, designed as a grading step, has a width of 180 mm
- » In accordance with EN-ISO 14122-4 and AS1657-1992
- » Fixed vertical ladders are suitable for combination with roof access hatches
- » For Australian standards, the hatch has to be at least 900 x 950 mm

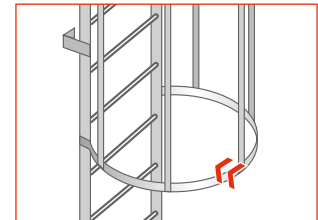

» Vertical fixed ladder with safety cage

» Safety cage

Warranty



» 10 years from delivery date covers roof hatches^{*)}



» 5 years from delivery date covers floor, wall and ceiling doors^{*)}



» 1 year from delivery date covers electrical operation, hook-on ladders, cage ladders, scissor stairs and fixed stairs^{*)}

^{*)} Full terms and conditions of warranty and delivery available on request.



The Netherlands

Gorter Luiken BV

Visit address:
Zuiderweg 12
NL-1741 NA SCHAGEN
THE NETHERLANDS

Postbus 265
NL-1740 AG SCHAGEN
THE NETHERLANDS
Tel: +31 224 21 98 60
Fax: +31 224 21 98 61
E-mail: info@gorterluiken.nl
Website: www.gorterluiken.nl

Belgium, France and Luxembourg

Gorter - Obelux

Meersbloem - Leupegem 21
B-9700 OUDENAARDE
BELGIUM
Tel: +32 5 523 2590
Fax: +32 5 531 9126
E-mail: info@gorterbelgie.be
Website: www.gorterbelgie.be

Germany

Gorter Deutschland GmbH

Ohligsmühle 7
42103 WUPPERTAL
GERMANY
Tel: +49 202 94 70 91 30
Fax: +49 202 94 70 91 31

ZEVEN
Tel: +49 4281 959 3045

E-mail: info@gorterdeutschland.de
Website: www.gorterdeutschland.de

Italy

Gorter Italia™

Via Nazionale 64
39040 Ora (BZ)
ITALY
Phone: +39 0471 810 089
Fax: +39 0471 810 875
E-mail: info@gorter.it
Website: www.gorter.it

Switzerland

Gorter Schweiz GmbH

E-mail: info@gorter.ch
Website: www.gorter.ch

Spain

Gorter España™

E-mail: info@gorter.es
Website: www.gorter.es

Denmark

Gorter Danmark™

E-mail: info@gorterdanmark.dk
Website: www.gorterdanmark.dk

Sweden

Gorter Sverige™

E-mail: info@gorter.se
Website: www.gorter.se

Hungary

Gorter Hungary Kft.

Helvécia, H-6034
Rákóczi Str. 84.
HUNGARY

E-mail: info@gorterhungary.hu
Website: www.gorterhungary.hu

Singapore

Gorter Hatches Singapore

E-mail: sales@gorterhatches.com
Website: www.gorterhatches.com

Argentina

Gorter Argentina™

E-mail: info@gorter.com.ar
Website: www.gorter.com.ar

Gorter Group™



Australia, Asia and Middle East

Gorter Hatches Pty Ltd

MELBOURNE
105 Wellington Street
St Kilda VIC, 3182
AUSTRALIA
Phone: +61 3 8648 6636

PERTH
Phone: +61 8 9463 6636

ADELAIDE
Phone: +61 8 8311 1136

BRISBANE
Phone: +61 7 3337 9936

SYDNEY
Phone: +61 2 8580 4436

E-mail: sales@gorterhatches.com.au
Website: www.gorterhatches.com.au

New Zealand

Gorter Hatches™

AUCKLAND
Phone: +64 9 280 4726
E-mail: sales@gorterhatches.co.nz
Website: www.gorterhatches.co.nz

Distributor:

